

SHAPE POWER

A Treatise On How Form Converts Universal
Aether Into Electromagnetic And Gravitic Forces
And Related Discoveries In Gravitational Physics

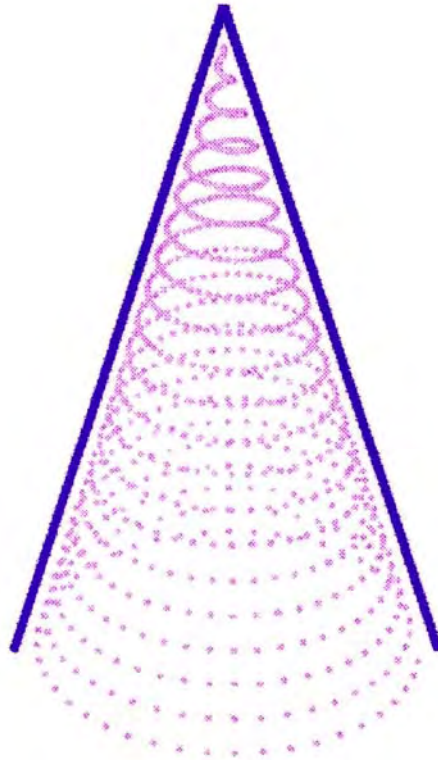

Dan A. Davidson

TABLE OF CONTENTS

Preface xi *Introduction xvii*

| | | |
|--------|---|----|
| 1. | AETHERIC PHYSICS OF SHAPE POWER | 1 |
| 1.1 | The Aether | 1 |
| 1.1.1 | Historical Terms For Aether | 2 |
| 1.1.2 | Aether And Its Conversions..... | 3 |
| 1.1.3 | Characterization Of The Aether | 3 |
| 1.2 | Nuclear Physics | 3 |
| 1.2.1 | Charge, Electrons, And Nuclear Particles | 4 |
| 1.2.2 | Atomic Structure | 4 |
| 1.2.3 | Magnetism..... | 5 |
| 1.2.4 | Gravity..... | 6 |
| 1.3 | Engineering The Aether | 7 |
| 1.4 | Shape Power And Aetheric Stress Waves..... | 8 |
| 1.4.1 | Shape Power Of A Point..... | 8 |
| 1.4.2 | Shape Power Of A Line | 9 |
| 1.4.3 | Shape Power Of Two Parallel Lines | 10 |
| 1.4.4 | Shape Power Of Two Intersecting Lines..... | 11 |
| 1.4.5 | Shape Power Of Multiple Intersecting Lines..... | 12 |
| 1.4.6 | Shape Power Of A Triangle | 14 |
| 1.4.7 | Shape Power Of A Tetrahedron | 15 |
| 1.4.8 | Shape Power Of A 12 Pointed Tesseract..... | 16 |
| 1.4.9 | Shape Power Of A Circle | 17 |
| 1.4.10 | Symbol From Mary..... | 18 |
| 1.5 | Natural Energy Flows | 19 |
| 1.5.1 | Energy Of Spiral | 19 |
| 1.5.2 | Modified Triangle Energy Flow | 21 |
| 1.5.3 | Planar Shape Power Lens..... | 21 |
| 1.5.4 | Why Drawn Lines Cause Aetheric Disturbance..... | 22 |
| 1.5.5 | Shape Power Symbol Combining | 23 |
| 1.5.6 | More Planar Pattern Energy Observations | 23 |
| 1.6 | Blocking Energy Using Rule Of Four..... | 24 |
| 1.7 | Summary Of Shape Power Physics..... | 25 |
| 1.8 | Bibliography..... | 27 |
| 2. | BACKGROUND HISTORY OF SHAPE POWER | 29 |
| 2.1 | Shape Power History..... | 29 |
| 2.2 | John Ernst Worrel Keely | 31 |

| | | |
|---------|---|----|
| 2.2.1 | Brief History of Keely | 31 |
| 2.2.2 | Keely's Discoveries | 32 |
| 2.2.3 | Verification Of Keely's Discoveries | 33 |
| 2.2.3.1 | Duplication Of Water Aetherialization | 34 |
| 2.2.3.2 | Physics Of Aetherealization | 35 |
| 2.2.3.3 | Levitation Of 4 Ton Iron Sphere: | 36 |
| 2.2.4 | Summary Of Keely's Research | 36 |
| 2.3 | Orgone Energy | 37 |
| 2.3.1 | Brief History Of Wilhelm Reich | 37 |
| 2.3.2 | Introduction To Orgone Energy | 38 |
| 2.3.3 | The Oraccu: | 38 |
| 2.3.4 | Constructive Biological Effects Of Orgone Energy: | 40 |
| 2.3.5 | Shape Power And Orgone Energy | 40 |
| 2.3.6 | Dangerous Orgone (Dor) Energy: | 41 |
| 2.3.7 | Summary Of Orgone Energy: | 41 |
| 2.4 | Implosion Physics: | 41 |
| 2.4.1 | Brief History Of Viktor Schauburger | 42 |
| 2.5 | Summary Of Implosion Physics | 45 |
| 2.6 | Bibliography: | 46 |
| 3. | EARTH ENERGIES | 47 |
| 3.1 | Earth Energies | 47 |
| 3.2 | Ley-Lines | 47 |
| 3.3 | Energy Grids | 48 |
| 3.4 | Ancient Shape Power Use Of Earth Energies: | 50 |
| 3.5 | Earth Energy Experience | 51 |
| 3.5.1 | Initial Tests With Clairvoyants: | 51 |
| 3.5.2 | Substance Transmissibility Tests To Green Energy | 52 |
| 3.5.3 | Earth's Aetheric Energy Grid: | 54 |
| 3.6 | Pranayama, Chi Gung And Tai Chi Exercises: | 54 |
| 3.7 | Feng-Shui, The Chinese Method Of Chi Control | 55 |
| 3.8 | Summary Of Earth Energies: | 55 |
| 3.9 | Bibliography: | 56 |
| 4. | PYRAMID ENERGY | 57 |
| 4.1 | Introduction To The Pyramid: | 57 |
| 4.2 | Great Pyramid Was Not A Tomb | 59 |
| 4.3 | Mathematical Relationship Of The Great Pyramid | 59 |
| 4.4 | Pyramid Energy: | 60 |
| 4.5 | Pyramid Energy Research Summary | 60 |
| 4.6 | Copper Pyramids Experiment: | 62 |
| 4.7 | Electrostatic Power Generation | 63 |
| 4.7.1 | Les Brown's Shocking Experience | 63 |
| 4.7.2 | Spiral Energy Off Apex Of Pyramid: | 64 |
| 4.7.3 | Electrostatic Energy At The Great Pyramid: | 65 |
| 4.7.4 | Static Pyramid Electrostatic Power Generation: | 66 |
| 4.8 | Theory Of How Pyramid Spiral Energy Is Created | 66 |

| | | |
|-------|---|----|
| 4.8.1 | Intersecting Lines | 67 |
| 4.8.2 | Concentrated Forces | 67 |
| 4.8.3 | Dessication Effects | 67 |
| 4.8.4 | Magnetic Orientation | 68 |
| 4.8.5 | Magnetic Generation..... | 69 |
| 4.9 | Summary Of Pyramid Energy | 70 |
| 4.10 | Bibliography..... | 71 |
| 5 | SHAPE POWER AND "SACRED GEOMETRY" | 73 |
| 5.1 | Sacred Geometry..... | 73 |
| 5.2 | Geometrical Figures Of Sacred Geometry | 74 |
| 5.2.1 | A Point..... | 74 |
| 5.2.2 | A Circle | 75 |
| 5.2.3 | A Sphere | 75 |
| 5.2.4 | Platonic Solids | 75 |
| 5.3 | The Mathematics Of Sacred Geometry | 77 |
| 5.3.1 | Pi..... | 77 |
| 5.3.2 | The Golden Mean (Phi) | 78 |
| 5.3.3 | Perfect Right Triangles | 78 |
| 5.4 | Shape Power And Sacred Geometry | 79 |
| 5.5 | Shape Power, Sacred Geometry, And Consciousness | 79 |
| 5.6 | Summary Of Shape Power, Sacred Geometry | 80 |
| 5.7 | Bibliography..... | 82 |
| 6. | SHAPE POWER FROM CRYSTALS | 83 |
| 6.1 | Introduction..... | 83 |
| 6.2 | Crystalline Structure And Shape Power | 84 |
| 6.3 | Atomic Crystallography..... | 84 |
| 6.3.1 | Platonic Solids..... | 84 |
| 6.3.2 | Crystalline Structures | 85 |
| 6.3.3 | Lattices As Shape Power Energy Containers | 85 |
| 6.3.4 | Crystals As Aetheric Energy Healing Tools..... | 85 |
| 6.4 | Macro Crystallography | 86 |
| 6.4.1 | Macro Lattice Structures | 86 |
| 6.5 | Summary Of Crystals As Shape Power Collectors | 87 |
| 6.6 | Bibliography..... | 88 |
| 7 | EXPERIMENTAL RESEARCH ON SHAPE POWER ENERGIES..... | 89 |
| 7.1 | Gravity Energy Detectors | 89 |
| 7.1.1 | Detection Of Gravity Stress Using Dielectrics | 89 |
| 7.1.2 | The Do Nothing Coil..... | 92 |
| 7.1.3 | The Physics Of Aetheric Stress (I.E., Gravity Flow) Detectors | 93 |
| 7.2 | Joe Parr Pyramid Energy Bubble Discovery..... | 94 |
| 7.2.1 | Shape As An Energy Sensor..... | 94 |
| 7.2.2 | Dynamic Pyramid Es Generation | 95 |
| 7.2.3 | Joe Parr Gravity Wheel Experiments | 98 |

| | | |
|-------|---|-----|
| 7.2.4 | Force Fields Of The Gravity Wheel Experiment | 100 |
| 7.3 | Duplication Of Gravity Wheel Experiments | 101 |
| 7.3.1 | Gravity Wheel Experimtal Setup And Results | 101 |
| 7.4 | Astronomical Corellations With Great Pyramid..... | 104 |
| 7.4.1 | The Taurus/Pleiades Connection | 104 |
| 7.4.2 | The Orion Connection | 106 |
| 7.5 | Clairvoyant & Dowser Examination Of Joe Parr Experiment | 08 |
| 7.6 | Aluminum Pyramids And Jp Energy Observations..... | 108 |
| 7.7 | Critical Parameters Of The Pyramid Gravity Experiments... | 109 |
| 7.8 | Summary Of Experimental Effects Of Shape Power | 110 |
| 7.9 | Bibliography..... | 111 |
| 8. | NUCLEAR STRUCTURE - BASIS OF SHAPE POWER | 113 |
| 8.1 | Introduction | 113 |
| 8.2 | The Torroidal Electron | 115 |
| 8.2.1 | Physics Of The Torroidal Electron..... | 120 |
| 8.3 | Atomic Structure..... | 126 |
| 8.4 | Magnetism | 128 |
| 8.4.1 | Gravity..... | 128 |
| 8.5 | Summary Of Nuclear Structure | 130 |
| 8.6 | Bibliography..... | 131 |
| 9. | EGYPT RESEARCH EXPEDITION | 133 |
| 9.1 | 1997 Shape Power Research Expedition To Egypt..... | 133 |
| 9.2 | Egyptian Expedition Overview | 133 |
| 9.3 | Sonic Creation Of The Pyramid Force Fields | 134 |
| 9.3.1 | Acoustic Analysis Of The King's Chamber | 134 |
| 9.3.2 | Finding The Pyramid Forcefield Frequency..... | 134 |
| 9.3.3 | Interstellar Beacon | 135 |
| 9.4 | Magnetic Field Measurements At The Great Pyramid | 136 |
| 9.5 | Evidence For Advanced Technology In Ancient Egypt | 137 |
| | Appendix A. SACRED ENERGY MOVEMENTS..... | 141 |
| | Appendix B. TRUNCATED TABLE OF NUCLIDE DATA | 147 |

PREFACE

By Jerry W. Decker
PO Box 111786
Carrollton, TX 75011

www.keelynet.com

There are fields of study which are relatively unknown to the general public. Though 'Pyramid Power' is well known, few have pursued it to other geometric forms and the phenomena which can be produced by understanding what is happening. Some of the key early researchers into Shape Power and the more specific Pyramid Power include Pavlita, Belizal, Turenne, Drbal and Flanagan.

Practical Aether Engineering is accomplished in nature by the use of various geometric forms and patterns as witnessed in the fibonacci series, fractals, tiles, cones and tetrahedral shapes. Entomologist Phil Callahan has shown how insects and some plants use geometric shapes to collect and transmit electromagnetic and acoustic waves.

When one understands that Aether, being the basic substrate of the universe, can be interferred with to such a degree as to produce all manner of energy and matter aggregations, it follows that everything is a result of Aether Engineering to various degrees.

Dan Davidson has been on the cutting edge of the aether engineering field for most of his adult life. In our many discussions and information exchanges over the years, I have found Dan to be one of the most reliable, consistent and serious investigators I've had the privilege to know. Few people have Dan's natural ability to cut to the chase and look for what is practical in the alternative science fields, as opposed to those who prefer to promote phenomena as unknowable mysteries or unproven claims.

It takes not only a great amount of dedication and perseverance, but also a considerable investment of personal time and money to make a difference. I have found that Dan puts his money and time where his mouth is and actually does the experiments to refute or validate claims.

One other key gift that I have found Dan to possess is his openness to use other than mechanistic approaches in the study of alternative science.

For instance, in some cases, Metaphysics is just as valid a tool as is the use of hardware and it is a rare gift indeed to *be* able and willing to fill in those missing gaps by using information derived from such sources.

As far as I'm concerned, it is irrelevant as to the information sources that lead to a new technology, only that it works as claimed and can be replicated by others and put into practical use by everyone.

When you read Shape Power, you should keep in mind that Dan is describing a form of aether engineering in its early stages. Recent and current events lend ever greater credence to the idea that long dead civilizations understood these aether principles and used them in their everyday lives. I believe that what you will read in Shape Power is a description of what will eventually lead to radical new technologies.

The essence of how geometric patterns can influence energy flows is exactly the same as how antennas and other resonating structures work. Since everything resonates and establishes an information and energy transfer between two or more resonant bodies, then a two dimensional pattern can precisely resonate to a three dimensional structure.

Just as a microwave horn or an antenna collects or transmits wave energy, so too can geometric patterns be used to collect, transmit or modulate surrounding energy fields, including aether.

17th century Cymatics researcher Ernst Chaldni found that vibrating waveplates would allow you to actually see sound waves as a two dimensional image. Hans Jenny discovered how to expand these two dimensional images into three dimensional forms which clearly show the shape of both simple and complex waves.

John W. Keely used such vibrating waveplates as an early, yet more advanced form of oscilloscope, allowing him to see not only the waves but how they interacted with each other. The waveplate principle was the basis for his ultraviolet projection microscope enabling him to view vibrating atoms on a screen.

Modern experiments with ferrofluids driven by a speaker magnet show an amazingly complex and beautiful display of either static or dynamic three dimensional wave structures, depending on whether the tones are fixed or changing.

In metaphysics, we find the use of geometric mandalas as consciousness focusing tools. These serve as the two dimensional form. When this two dimensional form is expanded into three dimensions, the mandala now becomes the vocalized spatial pattern called the mantra (yantra). Once converted into three dimensions, it now has an energetic structure.

The geometric principles of Shape Power as described in this book are these two dimensional forms functioning as aetheric or subtle energy waveguides.

Shape Power geometries are routinely used in the protective rings of ceremonial magic, the construction of amulets and talismans as well as the sigils (signatures) of various demonic or angelic entities. These patterns produce correspondences (resonances) to establish a contact with the desired entity or influence. By stimulating such a Shape Power geometry, you literally evoke or call forth the influence, just like making a phonecall.

There is a story about a group of experimenters who etched the sigil of the elemental spirit of wind onto a printed circuit board. The board was subjected to a high density fluctuating magnetic field (using various frequencies until an effect was noted). After a few minutes of excitation, the wind outside the building took on tomadic velocities and the building collapsed as the wind entity attempted to interphase with the resonator.

In a more practical sense, Shape Power can be understood as a means of biasing energy flows into a preferred pathway. That pathway is the geometry that reflects as a 3 dimensional structure, resonating and exchanging energy with other like resonant structures because they are now tuned.

Dan describes an interesting finding where a flow in a two dimensional pattern can be biased to follow a given pathway. He found that the pattern must be drawn with one continuous stroke of the pen, instead of being drawn in sections. As I understand this, as the pen or pencil moves to draw the pattern, crystals are deposited which point in the direction of the pathway, like fallen dominoes, serving as a kind of waveguide for subtle or aether energy.

Perhaps something of this nature might serve to create a conduit for the biasing of an energy flow into a collector. Once the collector is charged, it can be extracted by draining it off or in the form of a sudden discharge.

Another claim that illustrates how Shape Power could be used is in the Incunabula files. Under the premise that there are an infinite number of other worlds coexisting with us but slightly out of phase, a device was created that used a sensory deprivation tank, a television screen to project a two dimensional pattern and a solenoid-wired helmet to send out a three dimensional electromagnetic pattern resonating to the two dimensional image.

The Incunabula files indicate that the mandala/mantra for 5 alternate Earth's had been found and that a subject could be physically shifted to another reality simply by being exposed simultaneously to the 2D and 3D map for that location. Again, Shape Power.

Yet another concept using Shape Power is Tom Beardens 'tulpoids', which are entities from alternate realities. Under the right conditions, these entities can shift from their reality to ours, even leaving physical

traces whilehere. The technique involves charging an entity to an energy level that matches the target reality, then presenting the mandala/mantra images to enable the shift. Once the energy level of the alien entity returned to its natural energy state, it would shift back to its

home reality. The point that Bearden is making is that all possible worlds and creations exist, even on mental levels, so by producing a sustained pattern, you actually create that reality somewhere in the omniverse. Using Shape Power, it might be possible to shift that desired micro-reality into our own.

Science fiction writer John Campbell wrote a story about the Hieronymous radionics machine, where a blank plastic credit card was heated to soften the plastic. A radionics machine *was* tuned to a given pattern (signature) which was electrostatically projected between two metal plates. When the heated plastic was placed between the plates and allowed to cool, an electret was formed that continued to broadcast the pattern without any outside source of power. The pattern is a signature which has a three dimensional Shape resonating to a tuned reality as determined by the will of the radionic machine operator.

Dr. Thelma Moss at UCLA determined the brainwave patterns for various emotional and physical states. These patterns, recorded on a chart recorder in two dimensions, can be projected into a subject to produce a desired effect. The projected pattern is again three dimensional and thus a structured Shape. Dr. Michael Persinger has found that thoughts occur in the brain as three dimensional forms, which are reduced by instrumentation to two dimensional patterns.

The Egyptian god Thoth was keeper of the Words of Power, used to produce controlled phenomena when spoken with the correct intonation and pronunciation. In the case of Isis healing her child of a fatal scorpion bite, the use of a specific word of power caused the poison to be expelled from the body and the life force to return. Other legends and myths also refer to the use of such words of power. The words of power produced a three dimensional pattern which would resonate with the aether to produce a desired effect or reality in matter or energy.

Edward Leedskalnin, builder of the famous Coral Castle in Homestead, Florida claimed he had rediscovered how the Egyptians built the pyramids. We must take him seriously because he left the entire castle as a physical proof of his ability to move large stones without the use of equipment. Neighbors said he 'sang' to the stones, but there was never an eyewitness to testify to this technique. Perhaps he discovered the words of power that could be used to produce an aether and gravity deflection pattern leading to levitation.

One of the greatest problems with Shape Power at its current stage, is the lack of instrumentation that can directly detect quantified changes in aether. The secondary and tertiary effects of aether which manifest in

the forms of magnetism, electricity and gravity fluctuations as well as the use of sensitives is a truly inspired approach.

Along with the use of the voltmeter, gaussmeter, ammeter, radionics machines and gravity wave sensor, living organisms such as plants can also be used as tools to show beneficial or detrimental effects from a pattern being tested. Muscle testing using Kinesiology is yet another means of determining whether a pattern is generally harmful or beneficial to a living system.

What would be some of the practical uses of Shape Power once the process was understood?

1. The development of tuned patterns that can be worn on the body to redirect ambient energy in such a way as to protect one from harmful energies or to attract beneficial energies. Students of the occult refer to these as amulets or talismans.
2. In the course of my life, I've often experienced people who unknowingly cause machines to malfunction by their very presence. A pattern could be created that would filter such detrimental or enharmonious fields and cancel them out by using a 180 degree phase shift. Such a technique could extend the life and uptime of any type of equipment.
3. An entirely new branch of energetic medicine using specific 2D and 3D projected patterns to produce a very real effect from such virtual stimulations. There would be no drugs or physical pollutants which often lead to side effects.
4. Discovery of geometries or patterns that might help to shunt additional energy into or around a near unity machine to drive it into a beyond unity condition.
5. Interactions with the aether to control its flow into matter, thus altering its weight, characteristics or very existence.

Clearly, Shape Power has many possible uses and the avenues for discovery are wide open to those who wish to pursue the subject. Dan has shared his knowledge so that others will be inspired and see the possibilities of how Shape Power can be used to improve our lives.

INTRODUCTION

"Shape power" is the ability of multi-dimensional shapes to manipulate the local space energy. In this treatise I shall use the term "aether" to denote the local space energy field which permeates all space and time. The aether as a term and a concept is not currently accepted in academic circles because the aether was supposedly disproved back in the early part of this century by the Michaelson-Morley experiment. Flaws in the experiment caused new experiments to be run which indicated the existence of the aether; however, the orthodox physics community has not accepted these results. Additionally, research in the last 20 years has brought the aether back in a new guise called "zero-point energy" (ZPE). I prefer the term aether because it connotes a much broader concept than ZPE.

We are surrounded by natural and man-made shapes. From the remarkable geometry of the atomic and sub-atomic realm, to the symmetrical beauty of flowers and seashells, to the shape of planets and galaxies, we find a kaleidoscope of shape which defines, in an infinite number of ways, our miracle universe. All natural shapes are the result of natural forces at work and, as such, are tuned into these natural forces because they are a part of these forces.

I first used the term "Shape Power" in my first book on free energy, "Energy: Breakthroughs to New Free Energy Devices". At that time I devoted an entire chapter to the effects of geometrical shapes manipulating the aetheric field around them. The prime example of this is the ability of the pyramid shape to collect and focus aetheric energy. Numerous books have been written on "pyramid energy" and pyramids have gone and still go through various stages of fad within the new-age circles. The ability of pyramid energy to cause various effects is well documented.

Every shape manipulates aether in some manner. A cone is an example of an infinite sided pyramid and as such will do many of the same things which a simple pyramid does. The American Indian teepee is an example of a near conic shape which has many of the same energy effects as the pyramid.

This book will explore how different shapes manipulate the aether and how Shape Power can be used by you to enhance your life, your home, office, and your general well being.

Shape Power has been used throughout known history and back into remotest antiquity. Its most common manifestation has been in the use of amulets, ceremonial magic, and occult practices. Symbols such as the square, cross, and triangle occur regularly in occult symbols. The cross has an uncountable number of permutations and its association with Christianity is a recent phenomenon in known history.

In this modern day, most people do not associate symbols as foci of energy and power. For them, a symbol is nothing more than an artistic or common figure which may or may not have any meaning and if they do have any association of power with respect to a symbol, it is merely the idea of possible power associated with an organization or activity that uses the symbol. For example, a company logo would have no intrinsic power in itself; however, the company may be a powerful organization. The use of the pentagram (i.e., a five pointed star) in both white (i.e., constructive with center point up) and black (i.e., destructive with center point down) ceremonial magic is well known to those who have dabbled in the occult sciences. The Christian cross and the Jewish Star of David are common religious symbols with certain mystic power associated with them.

When first studying Shape Power and symbols, I wondered how a symbol could be used for both constructive and destructive purposes even to the point of questioning if the symbol really had anything at all to do with the magical processes. I have long since learned differently, and I invite you to learn some of these exciting things about simple shapes, which, if you apply them, can enhance your life and understanding of the universe in which we live.

In order to study any type of energy phenomenon, instrumentation is needed to make known what is happening with the energies. In physics and electronics we have detection instruments such as voltmeters, gauss meters, oscilloscopes, cloud chambers, ammeters, electromagnetic field meters, scanning microscopes, telescopes, etc., to detect and measure the physical forces and effects associated with them. In the case of the aether, there have been relatively few real instruments until I invented instrumentation which would detect aetheric forces and measure their effects. These instruments have enabled some of the discoveries in this treatise to be understood.

In addition to physical instrumentation, I have also used clairvoyants as human instruments when I have been able to prove conclusively that they have their inner sight open. A true clairvoyant is able to see the energy fields of the aetheric plane such as the light around a person (i.e., the aura), around various activities of light in nature (e.g., around and inside trees and living organisms), around geometrical shapes, around magnets, can see into matter, has both microscopic and telescopic vision and many other remarkable abilities. They can see the flow direction of subtle energy fields, its color, and general shape. My

experience in psychic research and psychological testing enabled me to identify some first rate clairvoyants who have provided additional, very valuable, insight into the science of Shape Power.

In this book, I have lumped all the clairvoyants for purposes of simplicity. This was done to protect the various identities as they all wish to remain anonymous. I used both male and female clairvoyants for various testing.

It is amazing what we've been able to prove so far. It's better than using an oscilloscope on electronic circuits. Using clairvoyants as the test instrument is total real-time feedback on exactly what is happening to the energy. As an example, I ran some tests on various materials to find out what happens with aetheric energy transmission through the materials. When clairvoyants were used, they explained what they could see happening as the aetheric energy interacted with the different materials; then we used electronic instrumentation to verify what was observed by the clairvoyant.

For the most part, man builds and creates with little regard to shape other than as a functional mechanism to contain space and to occasionally add aesthetic beauty. It is hoped that by making known the rules of how shapes manipulate energy, that everyone, from inventors, artists, and architects, to each of us as creative beings, can use these scientific rules to create a better world, filled with constructive shapes and designs which uplift and ennoble us all.

May 1997
Sierra Vista, Arizona

Dan A. Davidson

CHAPTER 1

AETHERIC PHYSICS OF SHAPE POWER

This chapter discusses my basic discovery of how shape power works and the energies (i.e., the aetheric forces) which drive the nuclear forces.

1.1 The Aether

Fundamental to understanding shape power is how the luminiferous aether interacts with matter. The basic premise is that all matter is simply a special case of the all pervading universal energy filling all space; namely, the aether. Over the years, the existence and understanding of aether has evolved as the basis for gravity and free energy effects at a micro and macro level. Laboratory experiments have shown that superluminal energy and information transfer have been effectively accomplished via aetheric engineering, which effectively eliminates the theory of special relativity and its assumptions of a constant speed of light.

Aether can be modeled as a superfluid which has little or no measurable viscosity. This model aether is developed in a later chapter where many of the basic universal constants describing physical phenomena with magnetic, electrical, and gravitic formulas are developed.

My research over 35 years proves the existence of aether as a reality. Modern physics has focused on the first experiments which Michelson

and Morley did in the early part of this century showing no ether drift; however, the experiments were flawed in design and later experiments implied the validity of aether theory. Later experiments by Trouton and Noble, Sagnac, Michaelson and Gale, Thirring and Lenze, and Fizeau, all imply that aether exists. John Keely performed extensive experiments in engineering the aether, including producing various gravity phenomena, controlled breakdown of matter into pure aetheric force and then using aether in experiments, etc.

1.1.1 Historical Terms for Aether

There are many terms, which when analyzed, lead to a characterization of a common space energy. Terms such as prana from Hindu/Yogi literature, ether or aether from physics and metaphysics prior to the late 20th century, orgone energy from the breakthrough research of Dr. Wilhelm Reich, chi from ancient to modern Chinese medicine and martial arts in general, all have very similar characteristics.

One term which is used in many of the new science circles is "zero point energy" (ZPE). From classical physics, we learn that atoms can be thought of as miniature solar systems with electron planets orbiting a nuclear sun. The electrons, according to classical physics, should radiate away their energy and spiral into the nucleus. This obviously doesn't occur. So physicists invented quantum mechanics to explain away the actual observations.

One of the findings of quantum theory was that a simple oscillator, such as a pendulum, would not really come to total rest but would continue to "vibrate" randomly about its "zero point" with a small amount of energy always present, thus so-called "zero-point energy."

Because of the many possible modes of propagation (frequencies, directions) in open space, the zero-point energy integrated over all possible modes is an extremely large energy density. In fact, it is much greater than the nuclear energy densities which can be equated to the famous Einstein equation $E=MC^2$.

Analysis of the properties of ZPE lead to the conclusion that matter is sustained by ZPE and can in fact be modeled mathematically as the basis for matter. The basic forces such as gravity, nuclear binding force, electromagnetic forces, electron charge, and inertia are all derivable from ZPE. So we come to the conclusion that ZPE is really another name for aether. The only redeeming feature, in my mind, is that it allows physicists to save face by inventing a new unsullied term for aether which has a disreputable name in the physics community due to it being "disproved" by the early Michaelson Morley experiment. "A rose by any other name...."

The aether spoiling of the ter with an "a" in front was used extensively in ancient literature. I prefer the term "aether" to distinguish it from the word ether which is an anesthetic.

1.1.2 Aether and Its Conversions

It is my contention that aether manifests in myriad ways. Aether interacts with three dimensional matter and matter is a bound form of aether. All the various forces such as gravity, magnetism, electricity, and the nuclear forces are due to activities in aether.

1.1.3 Characterization of Aether

My research and discoveries have led me to characterize the most basic attenuation of aether as follows:

1. A superfluidic particulate medium which pervades all space.
2. A medium which in its various modes is the building block of the physical universe.
3. A medium which, in one of its modes, is responsible for all the known grosser physical forces such as magnetism, electricity, electric charge, gravity, inertia, and the strong and weak atomic forces.
4. A medium which is controllable by our mind and can be manipulated by our thoughts.
5. A medium which can be intensified and manipulated into any force or manifestation by the use of materials, shapes, and grosser forces.

This book will examine the aether as many of these characterizations but primarily from the view of shape power which is the ability of geometrical and atomic structure to modify, intensify, focus, and in general, "qualify" or give specific qualities to aether and its various characterizations.

1.2 Nuclear Physics

It is quite possible to derive the nuclear structure of matter as well as the basic atomic, nuclear, and electromagnetic constants by analysis of aether. By treating aether as a hydrodynamic fluid^{1,2} and nuclear particles as torroidal (i.e., ring or donut) shapes, one can derive all the known physics of the atom, resulting in a new, satisfying, atomic morphology. Keep in mind that the torroid is a special case of a self-

sustaining vortex. This mathematical model is developed in greater detail in chapter 8 of this book.

1.2.1 Charge, Electrons, and Nuclear Particles

The charge of matter is due to its interchange with aether. The electron as well as some of the other subatomic particles are self-sustaining vortices in a fluidic particulate aether. The electron, to be a stable particle, is a vortex ring or torroidal structure made of aether.

Charge represents a difference in concentration of aether between two points (i.e., a gradient in aether). Mass (i.e., atomic particles) is made of aether, aether continually flows into and out of the particles as vortices, and the charge is due to its being at a different concentration of aether at a point in time and space than the local aether concentration. The electron's charge is due to aether flowing into and out of the vortex and the fact that the electron ring is a concentration of aether..

Analysis of the proton leads to the conclusion that it is also an aetheric torroidal vortex with a different radius and ring cross section^{3,4}. The proton torroid, when it is broken up, devolves into an unstable substructure which is made of three quarks, also torroids, which spin as a complete whole to form the proton. Experimental evidence in cloud chambers indicates that the quarks are unstable particles and so dissipate rapidly.

A neutron is made of a proton and an electron in bondage in a nucleus, which splits up when removed from the nuclear binding forces.

1.2.2 Atomic Structure

Atomic structure builds according to the rules of geometry and the polarity of atomic particles. Polarities are the result of aetheric flows into and out of nuclear particles where the flow directions produce the magnetic poles.

John Ernst Worrel Keely was the first sub-atomic physicist, who characterized nuclear structure. His elucidation of atomic structure was derived from his development of the science of vibratory physics. One of his discoveries was that of the substructure of the proton⁵. He discovered it was a vortex made of three sub-nuclear particles, also vortexes. Further research led him to the idea that this three particle substructure continued down to smaller and smaller levels of particles within each particle. Keely claimed to have learned to control the substructure 27 levels down from the basic proton.

The Keely atom is depicted in a stylized format in figure 1.2.2-1. The first level of substructure was finally theorized in the orthodox

community by Feynman in 1958. Keely's discovery antedated Feynman by over 60 years! Feynman called three particles making up the proton, "quarks".

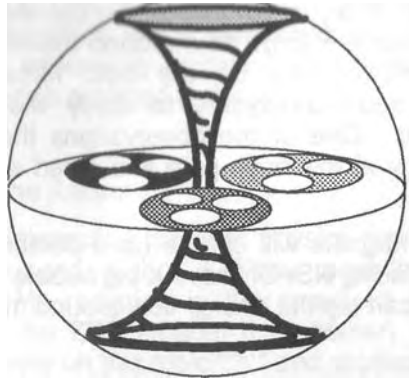

Figure 1.2.2-1. Keely "Atom" (i.e., Proton) Showing Torroidal Structure

1.2.3 Magnetism

Magnetism exists as:

1. The earth's natural magnetic field which is theorized to be created by the flow of the earth's liquid core.
2. A permanent magnetic field around magnetized materials.
3. A static or alternating magnetic field around current-carrying wires where the current is either direct current (DC) or alternating current (AC), respectively, and the magnetic field is either static or dynamic, respectively.
4. The magnetic field of an electron torroid ring and is due to the local aetheric field flowing through it and the charge differential which it represents.

In cases 2 and 3 above, the field is created by enough of the electrons in a material being aligned so that all of their aetheric flows are additive and create a large flow of aether in the area around the magnet. So we see that magnetic fields are all the result of vortical flows of aether.

The strong polarity of magnets is due to the concentration of aether flowing through the poles. I have conducted tests with clairvoyants who are able to see the aetheric flows, and they have verified that a magnet is essentially an aether pump.

Magnets have an energy flowing around them as I and many other new science researchers have postulated. My laboratory experiments, plus experiments with clairvoyants, have proven that the magnetic field around a permanent magnet is, in fact, a vortical (flow of aetheric force). The atoms act as aetheric pumps to move aether and when many of the atoms are lined up as in a permanent magnet the atoms' aetheric flows all add together to create a large flow around the magnet. The novel research, in the last century on the odic force, by Baron von Reichenbach¹³, used clairvoyants to study the energies around magnets, people, etc. One of the observations they made was that there was blue energy at the north pole and a red energy at the south pole.

Holding permanent magnets will charge up a person's energy field or aura. Two magnets facing NS-SN have a big bubble of energy between them. Shape power can tap the energy flow around magnets.

1.2.4 Gravity

Gravity is also a force related to the aether. As electric charge, E , is a gradient in aether, the gravitational force is a gradient of electric charge (i.e., a *grad* E). Thus, if the aetheric gradient is changed around an atom, the gravity force will also change. This was demonstrated in the Townsend Brown effect where a high electric gradient across a capacitor would affect its weight. The effect can be amplified by moving the entire mass which synchronizes aether flow through the mass.

Synchronization of aetheric flow into the nuclei of a given mass has been achieved by two main methods; namely, rotation or movement and sonically. Analysis of various apparently disconnected events where levitation was witnessed provides some important clues to a means of effecting synchronization of the nuclei. This was explained, in detail, in a paper by Davidson and Decker⁶. Also, T. Townsend Brown was quite open in publicizing his experimental results even though they were being funded in part by the Office of Naval Research out of San Diego. However, when he started rotating his gravitors on their axis the results suddenly became classified and all information on his experiments ceased. It is suspected that major levitation resulted and this breakthrough was classified to protect the discovery so it could be exploited for national defense.

Analysis of the phenomenon of inertia provides the major clue to how rotation could act to synchronize the flow of aether into the nuclear sub-structure of the gravitors. A pivotal paper in *Physical Review*, 1994, pp 678-694, by Haisch, Rueda, and Puthoff⁷ theorizes that inertia is a result of the resistance of mass to move through the zero point energy (ZPE) field (i.e., aether) because the mass, at the nuclear level, is linked directly into aether. Puthoff and his friends did a nice mathematical

proof of what Keely stated in 1896 that inertia was a result of the resistance of mass to the local aetheric field. Hence, it is easy to see that movement/rotation would cause the aetheric flows of the mass to reorient with respect to the direction of movement.

Sonic stimulation performs the same thing by getting all the atoms of the mass to resonate together, which synchronizes aetheric flows into the nucleus. Several interesting levitation effects have been observed where sonic stimulation assisted in the levitation.

1.3 Engineering the Aether

Some of the most interesting orthodox physics research relates to early work by Wheeler and Bohm. They postulated the idea that electromagnetic (EM) radiation is the result of interacting enfolded energy stresses in the ZPE stratum (i.e., aether). Tom Bearden has expounded extensively on this topic^{8,9,10} and applied the word "scalar" to these enfolded energy stresses in aether. Mathematically, a scalar has magnitude but no direction. Applied to aether engineering, a stress wave in aether would be instantaneously propagated into all time and space. It would also be a scalar when compared to EM radiation which has both magnitude and direction. The relationship of an aetheric stress wave to an EM wave is the premise that when two EM waves which are 180 degrees out of phase are combined, the energy of the two waves do not collapse to zero as today's accepted mathematics of EM phenomenon would argue; but instead, create an aetheric stress wave which contains the combined energy of the two EM waves. Stated mathematically, $E+(-E) = S$, where $S \neq 0$ where the symbol " \neq " is read "is not equal".

This mathematics of converting EM to an aetheric wave is akin to examining the forces when a block of steel is compressed in a powerful vice. The net external force on the steel is zero; however, internally the steel's atomic crystalline lattice structure experiences stress.

The most interesting aspect of this energy combining is the fact that the converse is also true. That is, when two aetheric stress waves (S and $-S$) which are 180 degrees out of phase are combined, the energy of the two waves combine to create an EM wave (E'). Stated mathematically, $S+(-S) = E'$ where $E' \neq 0$.

A pictorial of these two symmetrically reversible processes is shown in figure 1.3-1.

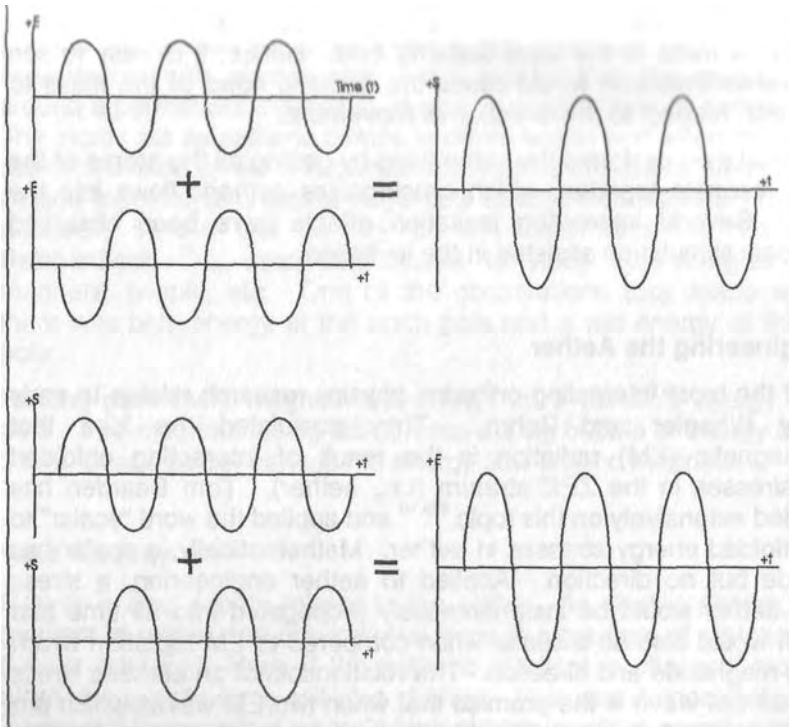

Figure 1.3-1 Conversion of Electric Wave (E) to Aetheric Stress Wave (S) and Vice Versa

1.4 Shape Power and Aetheric Stress Waves

We have now arrived at the point where we can discuss how geometric shapes modify aether and derive some basic rules which fit with observed phenomena.

1.4.1 Shape Power of a Point

The simplest geometric shape is a simple point but a point is a mental construct because it has no dimensions of length, width, or height. To have a useful geometric entity that we can work with we would be talking of a single aetheric particle (i.e., a vortex in aether). This has already been partially discussed. What we didn't draw in figure 1.2.2-1 was the flow of aether in to and out of the atom. This is simply a vortical, flow of energy into the atom. The more complex the atom (i.e., with many sub-atomic particles) the more complex the flows into the atom's nuclear *structure*. On a macro level for a complex atom, the flow will be oriented in a generally spherical pattern. In a simple atom like hydrogen, the flow will tend to look more like the lines of force around a small bar magnet. Most materials are made of much more complex

atoms than hydrogen so we can generalize and treat aether flow around in atom as generally radial with flow either toward or away from center of the atom. If we look at the flows closely, we would find that these flows are vortexing or spinning into and out of the nucleus. (See figure 1.4.1-1)

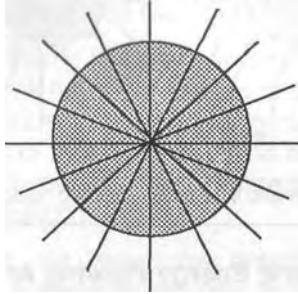

A complex atom with many orders of aetheric stress vortex flows (lines).
A simple atom like hydrogen would have only one vortex line in and out.

Figure 1.4.1-1. Cross Section of Vortex Stress Flows of Complex Atom.

1.4.2 Shape Power of a Line

The next level of geometric complexity is the line. In this instance we have an aggregated collection of atoms to form a line (i.e., from 2 or more atoms strung together to form a line).

First, let us consider the aetheric flows around two atoms next to each other which would be the simplest possible line. The aetheric flows in between the two atoms would either connect and aether would flow from one atom to the next or the flows would repel and the flows would squirt out perpendicular to the radial line between the two atoms. The rest of aetheric flows would form a lozenge type radiation around the combination of the two atoms.

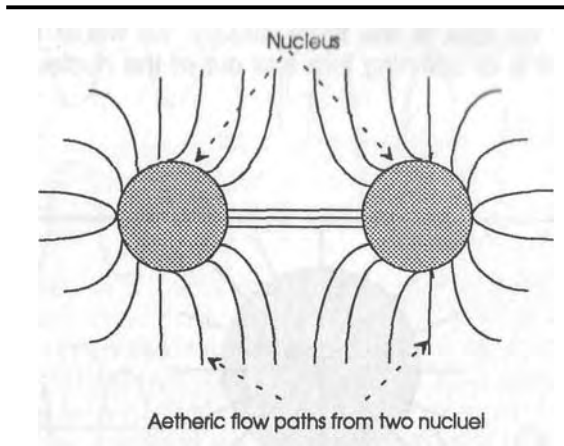

Figure 1.4.2-1. Aetheric Energy Flowing Around Two Atoms
Creating a Simple Line.

By adding more atoms to the line we simply elongate the lozenge of radiation around the line. The net result is aetheric flows perpendicular to the line. This is illustrated in figure 1.4.2-1. When this is extended to a longer line of atoms is illustrated in figure 1.4.2-2.

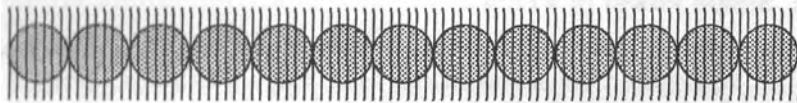

Figure 1.4.2-2. Side View of Line of Atoms with Aetheric Energy
Radiating From the Line.

1.4.3 Shape Power of Two Parallel Lines

A pair of lines parallel to each other is similar to the two atoms next to each other; however, in this case aetheric flows in between the two lines would either connect and aether would flow from the atoms in one line to the atoms in the next line, or the flows would repel and the flows would project out perpendicular to the plane between the two lines. The net result of this configuration is a simple plane of aetheric flows around the two lines. The proximity of the lines defines the amount of interaction. Again we end up with a lozenge type energy configuration.

1.4.4 Shape Power of Two Intersecting Lines

Now the fun begins. When two lines intersect, there is a gradient of aetheric intensity between the two converging lines. Did you get that?

Two intersecting or converging lines create an energy gradient in the aether.

The closer to the intersection of the two lines the more intense the interaction. Conversely, the farther away from the intersection the less interaction of aetheric flows of the two lines.

Because the nuclear aetheric flows are vortical (i.e., little spinning flows in the aetheric field) these flows will tend to orient to the least resistance between them. This means that aetheric flows will form larger vortexes close to the intersection of the two lines. The net result of aetheric flows is a vortexing effect between the two intersecting lines with the vortex most intense at the intersection.

With this configuration, we have now created a macro level, three dimensional, vortex in space with polarity from a simple planar figure. The intensity is greatest at the intersection of the two lines and least at the widest point of the two intersecting lines as is obvious in figure 1.4.4-1. Because this is a totally balanced flow of aetheric force between the two lines, there should be creation of a small amount of electron charge and a magnetic field but most of it would be concentrated near the intersection of the lines. Remember, a magnetic field, as discussed previously, is an aetheric vortex around the magnet so a vortexing in aether creates a magnetic field.

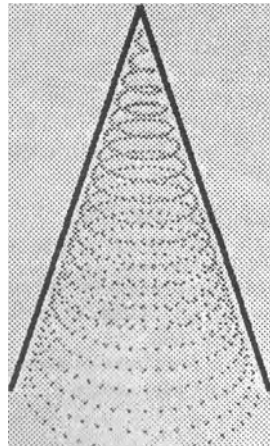

Figure 1.4.4-1. Aetheric Vortex Phenomenon Between Two Lines Intersecting

Clairvoyant and clairsentient testing was used to examine what type of energy patterns formed around the intersecting lines resulting in a

verification of my theoretical analysis and proving there is an intensification of the flow patterns predicted by theory. The vortex is clearly visible to the clairvoyant's sight and the flow and concentration of an ordered turbulence in aether at the intersection of the lines is also clearly visible.

1.4.5 Shape Power of Multiple Intersecting Lines

A large number of lines intersecting at a common vertex would lead create in the vicinity of the vertex a magnetic field and an electrostatic field.

Intersecting lines generate a flowing vortex of aetheric energy. The magnetic field of a permanent magnet is also a flowing vortex of aetheric energy as discussed previously. Q.E.D - Ergo - Eureka! A set of intersecting rods will therefore generate a magnetic field because the aetheric vortex flows at the intersecting of the lines are in fact a magnetic field. This means that intersecting lines or rods should also generate magnetic fields.

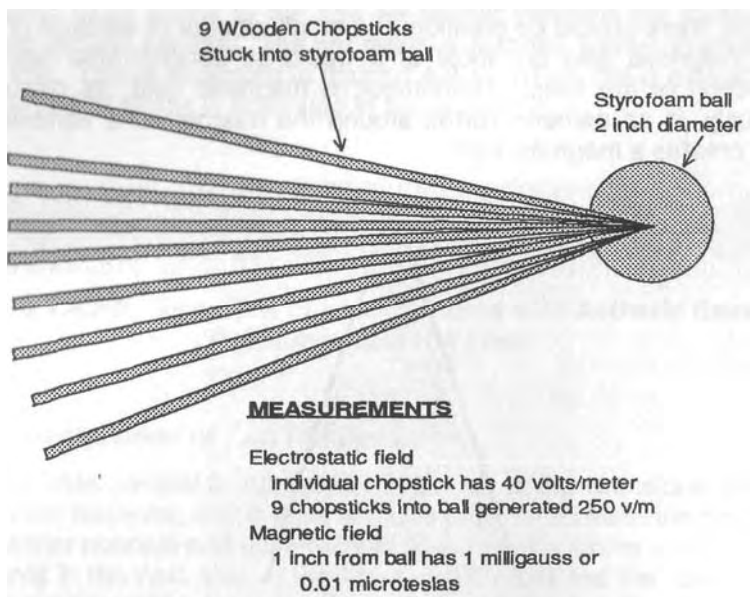

Measurements taken with an Alpha Laboratory Model 3 Tri-Field Meter

Figure 1.4.5-1 Generation of Magnetic and Electrostatic Fields with Intersecting Rods

A simple experiment was performed to test the hypothesis that intersecting rods would generate a magnetic and electrostatic field. These results are depicted in figure 1.4.5-1. Initial measurements were taken with a sensitive meter and a fluxgate magnetometer. The experiment was a resounding success. Intersecting lines create a magnetic and electrostatic field. This is a major breakthrough discovery wherein shape power aetheric physics predicts a previously unknown phenomenon.

Further experiments were done to verify this effect. Two types of pyramids were tested. A paper pyramid and a fiberglass pyramid were constructed with 4-inches bases and other proportions the same as the Great Pyramid. Each side had lines that went from one side of the pyramid and converged at the base of the pyramid in a lower corner. Figure 1.4.5-2 depicts the triangle with the lines that formed each side.

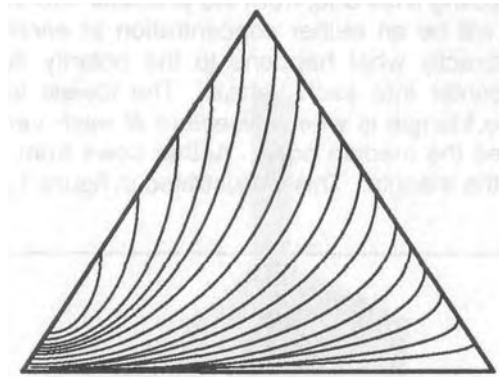

Figure 1.4.5-2 Sides of Pyramids Used in Magnetic Field Measurement Comparison Tests

Magnetic measurements were taken with a fluxgate magnetometer of the magnetic field at the base of each pyramid. Table 1.4.5-1 summarizes the measurement results.

Table 1.4.5-1 Pyramid Magnetic Field Measurements

| | Fiberglass pyramid with lines | Stack of 19 paper pyramids with lines | Single paper pyramid |
|-------|-------------------------------|---------------------------------------|----------------------|
| Gamma | 310 | 323 | 0 |

From table 1.4.5-1 one can see that the single paper pyramid had no measureable magnetic field and the fiberglass pyramid with the converging lines had a magnetic field of 310 gammas. To give the reader and idea of the relative intensity of this Shape Power created field, there are 20,000 to 50,000 gammas in the earth's magnetic field so the pyramid is generating a very small but measureable magnetic field. Accuracy of the magnetometer is +20 gammas so the 323 gamma measurement of the stack of paper pyramid shows the additive effect of multiple intersecting lines.

It should be noted that these measurements vary during the day due to small fluxuations in the earth's magnetic field plus the changing stress in the aetheric field caused by the earth's rotation which result in a different pressure from the sun during the day.

1.1.1 Shape Power Of A Triangle

A triangle is the connection of three lines at their end points. This takes us into three intersecting lines and, from the previous section, it is easy to deduce that there will be an aether concentration at each vertex of the triangle. This is exactly what happens to the polarity flow inside the triangle from the center into each vertex. The lowest level of aether concentration in the triangle is where bisectors of each vertex meet in a common point called the median point. Aether flows from this point into the three points of the triangle. This is illustrated in figure 1.4.6-1.

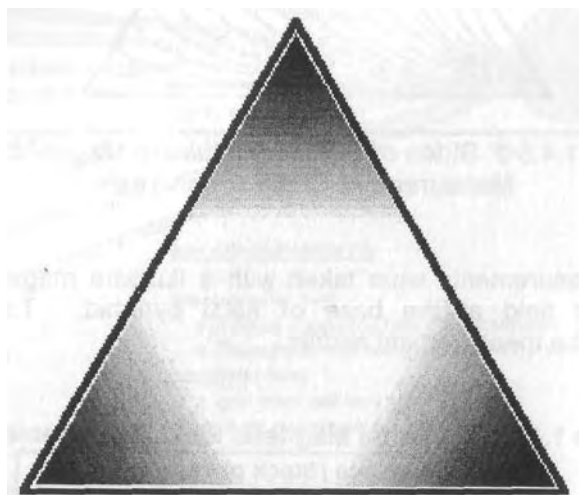

Figure 1.4.6-1. Aetheric Vortex Phenomena Within A Triangle.

If a triangle is broken up into three triangles, almost all the energy is focused at the center with a small amount at the outside vertices. If a circle surrounds the tetrahedron triangles, the energy is focused entirely in the center of the circle/triangle so a circle overrides the effects of the intersecting lines. In a figure where there are triangles around the periphery of a circle, the entire energy of the figure is concentrated into the triangles. It is as if the triangles gather and focus the energy in the circle.

1.1.2 Shape Power Of A Tetrahedron

A tetrahedron, the simplest of the platonic solids, is made up of three connected triangles to form a three dimensional figure with four vertices. The intersecting lines of the tetrahedron have a concentration of aether in a vortical pattern at the vertices, plus there is a large negative (polarity) stress concentration of aether at the geocentric center of the tetrahedron (i.e., at the 1/3rd height). This is illustrated in figure 1.4.7-1. The negative polarity at the center is a result of aetheric stress drawing on aether from the four corners.

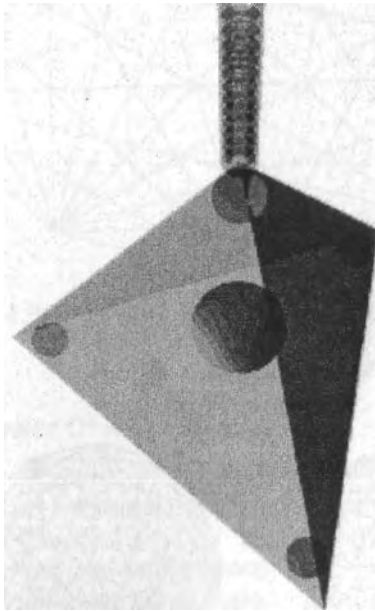

Figure 1.4.7-1. Aetheric Concentration Within A Tetrahedron.

1.4.8 Shape Power of a 12-Pointed Tesseract

A tesseract is a regular planar figure made up of points equally spaced around a circle with lines connecting every point to every other point.

The intersecting lines of the 12-pointed tesseract (12-tesseract) form many triangles and four-sided, irregular polygons. These geometric figures have an interacting concentrating affect on aether which creates a three-dimensional, multi-frequency pattern radiating out from the 12-tesseract which then acts as an agent to clear out bad/dark negative energies wherever the figure is located. The 12-tesseract is illustrated in figure 1.4.8-1. The frequency of the aether determines the color that we see.

The clairvoyant sees the energy from the 12-tesseract as a beautiful rainbow of many colors radiating from it for 20 to 50 feet. More importantly, this figure illustrates that it is possible to actually modify the frequency relationships of aether with relatively simple shapes. Up to this point, we have only discussed the concentration and focusing of the aether. The 12-tesseract actually creates a whole spectrum of colors from a colorless aether. This has tremendous implications because it shows that we can use shape to change the vibrational patterns of aether around the shape.

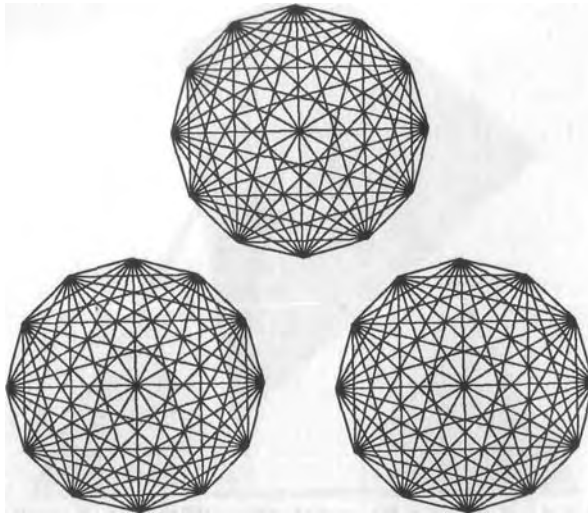

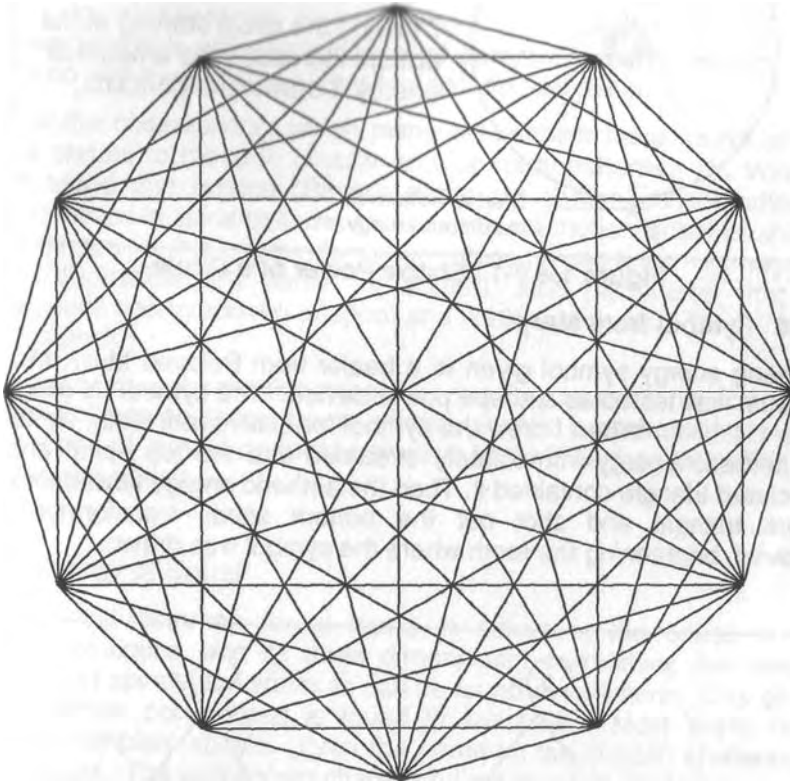

Figure 1.4.8-1. Shape Power of a 12-Pointed Tesseract

1.4.9 Shape Power Of A Circle

A circle with its concentration of aetheric energy is shown in figure 1.4.9-1. The circle can be represented as an infinite series of intersecting tangent lines. The focus point is the center of the circle. The intersecting lines actually cross energy fields in the center of the circle. Therefore, aether will be concentrated in the center of the circle. This means the circle acts as an aetheric pump to draw in energy and concentrate it at the center.

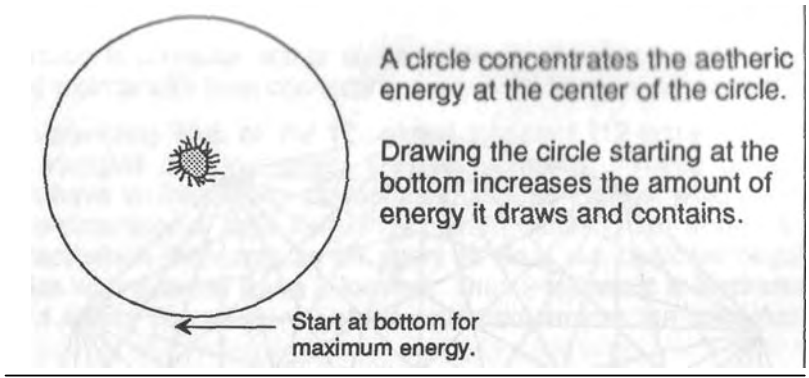

Figure 1.4.9-1. Shape Power of a Circle

1.4.10 Symbol from Mary

A healing energy symbol given to a healer from Beloved Mary, Mother of Jesus, was tested as a shape power device. The symbol is shown in figure 1.4.10-1. When I drew the symbol for clairvoyant tests, we found that aetheric energy immediately streamed into the top spiral and its associated triangle contained it. Then the aetheric energy flowed into the bottom triangle and shot out the bottom spiral, transformed and improved, brightening the room where the symbol was drawn.

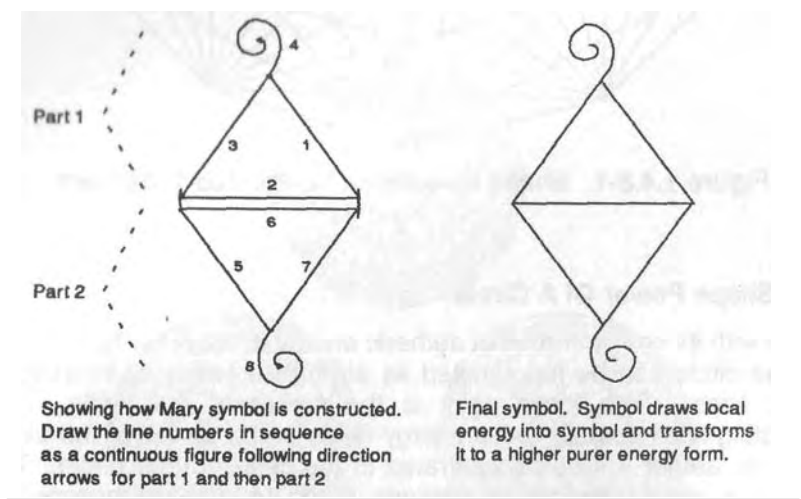

Figure 1.4.10-1. Shape Power of Healing Symbol

1.5 Natural Energy Flows

In section 1.4, a few simple geometric shapes were examined to show how simple patterns mold, shape, intensify and direct aether; even to the point of changing aetheric frequency relationships in the 12-tesseract to yield color modifications in the aetheric field around the tesseract. However, there is still another level of complexity within aether. This has to do with the fact that aether has natural flow patterns.

One of the observations, which many researchers have found, is that aether prefers to move in circular arcs or spiral patterns. Dr. Wilhelm Reich found that orgone (Reich's name for a high concentration of aether) moves in spiral patterns and its constant motion is that of spirals. Schauburger, in his groundbreaking research work on diamagnetic energy (Schauburger's name for aether), also discovered that the diamagnetic energy moved in spiral and vortical patterns. (See chapter 2 of this book.)

If we apply this observation of aether moving naturally in spiral and vortical patterns to shape power effects, then it is reasonable to infer that the use of curved or spiral pathways to mold and guide aether will enhance the effects.

1.5.1 Energy of Spiral

One of the most common forms found in nature is the spiral, a two dimensional figure, and its three dimensional correlative, the vortex. Examples of spirals and vortexes can be found everywhere. One of the most common occurrences is found in seashells. Most shells have partial or complete spirals. Even the common fan-shaped shells are a vortex shape. The well-known chambered nautilus with its highly regular logarithmic spiral is often used to illustrate the spiral. Another well known vortex format is found in patterns generated by trees and plants as their leaves form. The leaves usually follow a vortex pattern which is related to the Fibonacci numbers (i.e. 1, 2, 3, 5, 8, 13.....[n]+[n-1]). The study of this natural phenomenon is called phylotaxis.

When a spiral is drawn starting at the center and around counter-clockwise (CCW) toward the outside, the local aetheric energy is drawn into the center of the spiral and shot to the outside. When a spiral is drawn from the outside to the center, the energy is drawn from the outside into the center and transformed into a rainbow of colors and energizes the locality. The energy field, as seen by clairvoyants, radiates out about 4 feet from the center of the spiral and is truly a rainbow of beautiful, living colors.

If spirals are connected by drawing a spiral from the outside to the center and then continuing the line from the center to the outside of another spiral, and doing this for several more spirals that are connected

from the center of one to the outside of the next one, then energy is intensified tremendously. It is as if each spiral gathers more energy as well as intensifying the energies from previous spirals. Testing with sensitives also verified this most fascinating effect of the spiral as a shape power figure. If a person is at all sensitive to energies they can readily feel the increase in energy intensity.

It is interesting to note that the spiral structure correlates with some of the patterns of the neurological spiral vortex structures in the brain where spirals are connected to each other. From this we can deduce that the nervous system patterns in the brain act as a parametric shape power amplifier of the energies it is receiving; thus, collecting and amplifying the amount of aetheric energy in the brain. This interesting fact was discussed in my first book on free energy¹². Figure 1.5.1-1 illustrates a simple vortex.

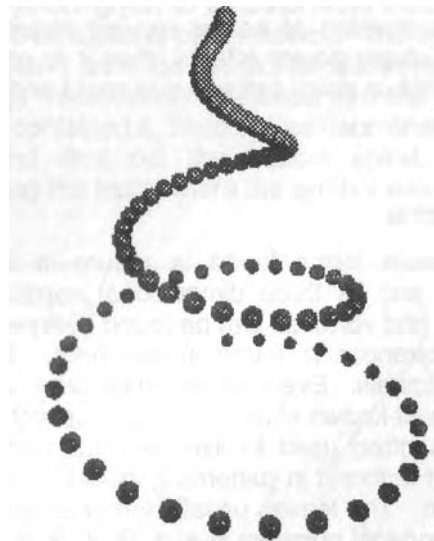

Figure 1.5.1-1 Vortex Pattern

One of the early shape power devices, sold as a product back in the 1970's, was a spiral etched onto a piece of copper-clad printed circuit board (PCB). The inventor claimed that the spiral plate would energize and make coffee, water, soft drinks, wine, and foods taste better. Obviously, this was taking advantage of the shape power aspects of the spiral. It would be interesting to know if the original spiral was drawn from the outside to the center. This effect could be greatly enhanced if many interconnected spirals were etched onto the PCB substrate. My experimental research shows that printed circuit board material, which is

made of epoxy fiberglass does not conduct aetheric energy and makes very poor shape power media.

1.5.2 Modified Triangle Energy Flow

To test the hypothesis that controlling aetheric energy with curved lines was more effective, a triangle was made with many curved lines where all the curved lines converged on one of the vertices of the triangle as is illustrated in figure 1.5.2-1. An identical triangle was also constructed with straight lines. The effects of this test were dramatic. The triangle with the curved lines had many times more aether flow and concentration than the triangle with the straight lines. Obviously, if you allow the aether to follow its natural flow patterns, the flow is much easier and faster than with straight lines.

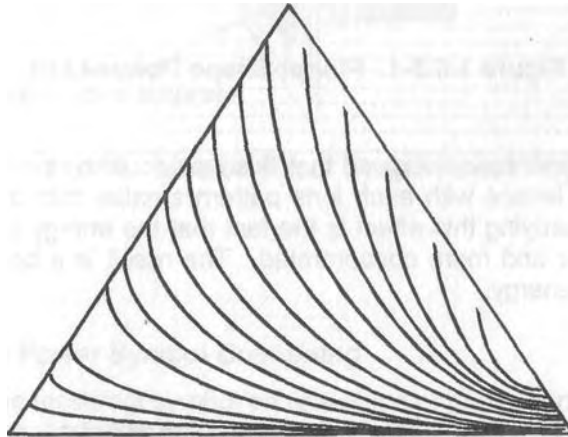

Figure 1.5.2-1. Curved Lines within a Triangle to Control Shape Power

1.5.3 Planar Shape Power Lens

Another example of a curved line shape power pattern is shown in figure 1.5.3-1. It was found that this shape power pattern generated a three-dimensional energy field. In this case the energy pattern was a beam of energy projecting out from the back side of the pattern for about five to six feet. The energy beam was vortexing out in a beam the width of the planar pattern. By experiment we found this pattern has maximum energy when the curved lines never touch the surrounding circle. If the curves touched the circle it was as if the circle blocked the curved spiral from collecting more aetheric energy and channeling it to the center of the circle. From figure 1.4.9-1 we know that a circle focuses the energy in the center of the circle. With the curved lines, the energy collection is accelerated and shot out from the center of the spiral pattern.

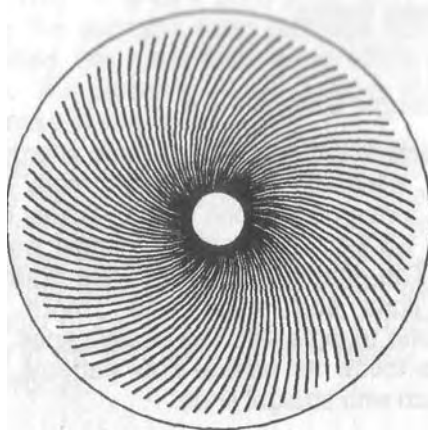

Figure 1.5.3-1. Planar Shape Power Lens

Further experimentation showed that this lens could be put into a series of cascaded lenses with each lens pattern smaller than the preceding lens. Accompanying this effect is the fact that the energy pattern keeps getting smaller and more concentrated. The result is a beam of highly concentrated energy.

1.5.4 Why Drawn Lines Cause Aetheric Disturbance

There are three phenomena associated with why the simple act of drawing a couple of lines on a piece of paper sets up patterns in the aether.

1. Two converging lines on the paper create a stress in the aetheric field and cause the aether to vortex.
2. The line on the paper is a different substance than the paper and will usually have a different conductivity than the paper for the flow of aether around it. If there is a stress in the aether at that point, then the differing conductivities will create eddy currents in the aether. See figure 1.5.4-1
3. The physical act of drawing any pattern in the aether creates an aetheric record and biases aether flows in the direction that the pattern was drawn. See figure 1.4.10-1 and section 1.5.1 on effects of drawing spirals in different directions.

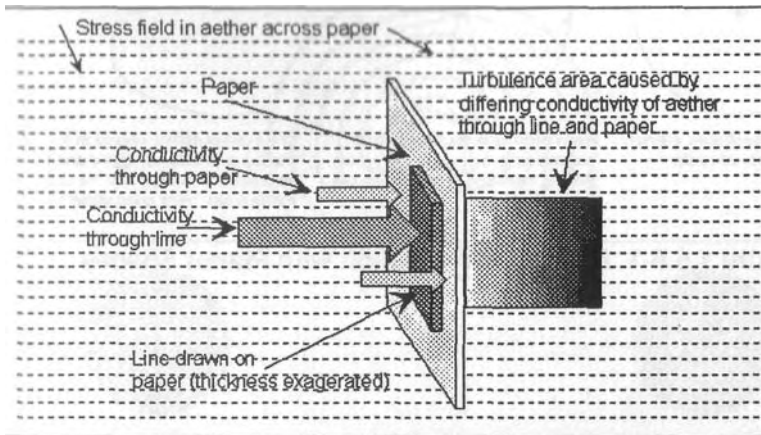

Figure 1.5.4-1. Line on Paper Shape Power Physics

1.5.5 Shape Power Symbol Combining

Combining the tesseract symbol on one piece of paper and the spiral on another paper and the papers set at right angles showed that the energies of the two symbols interact and are amplified. By this, I mean it intensified the energies in the room. This shows that we can use symbols interactively to intensify aetheric energy and convert it into any force we want since all forces are modes of aetheric energy.

1.5.6 More Planar Pattern Energy Observations

Another series of experiments were performed to check out the energy fields of three simple energy patterns. The symbols were the Sanskrit Om symbol, a circle with a dot in the center and a circle with petals inside. These are shown in figure 1.5.6-1.

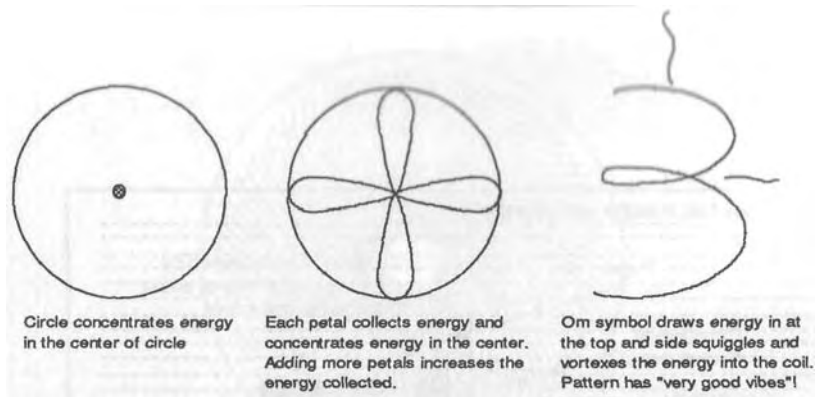
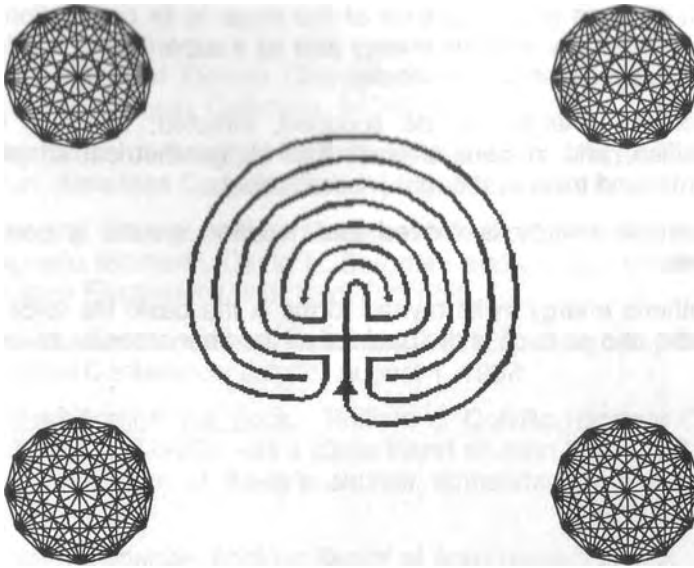

Figure 1.5.6-1 Energy Manipulation with Planar Shapes

1.6 Blocking Energy Using Rule of Four

In Divining, The Primary Sense by Herbert Weaver ¹¹, he recounts a discovery by a dowser, Lawrence Veale, wherein a simple cross of four lines would block the signal from a "witness" to the person it was attuned to. A witness is a term used in magic and dowsing for any object or substance which is either from a person or handled and used by only a single person. Examples of witnesses are hair, saliva, fingernail clippings, a personal comb, etc. The witness is aetherically tuned to one person and no one else.

To test out the rule of four, I had clairvoyants and clairsentients "look at" the energy pattern around a glob of my saliva on a piece of paper. They could see a tenuous energy connection between me and the saliva with a faint energy glow around the saliva. When I got closer to the saliva sample, the energy connection got stronger. I then drew four lines on the paper next to the saliva. The four lines or a cross only blanked out the connection to me when the symbol was between me and the saliva. There was still a faint connection to me when the four lines were not between me and the sample. To completely block the connection, four dots, squares, or four symbols had to circumscribe the sample. See figure 1.6-1 for a visual of how the rule of four works blocking the energy of a labyrinth.



The four tesseracts act as an energy blocking agent for the center labyrinth figure.

Figure 1.6-1 Rule of Four Using Tesseract to Block Energy of a Labyrinth

1.7 Summary of Shape Power Physics

My emphasis on the fact that two intersecting lines create a gradient in the aether and hence create a magnetic field is a fundamental discovery of tremendous importance. With this fact plus the fact that aether flows best in curved or vortical patterns, we can now unravel the mysteries of pyramid energy, mandala forces, magic symbols, crystal energy effects, the Altantean Power Crystal and the direct conversion of static aetheric energy into dynamic aetheric force. The conversion of aetheric energy directly into usable electric power will now become a reality through Shape Power.

The following are heuristic observations on controlling and manipulating aetheric energy.

1. Aetheric energy exists everywhere.

2. Aetheric energy is easily moved by motion of mass; however, the inertia of mass is a resistance of the mass to its connection to the aether. Basically aetheric energy acts as a superfluid with little or no detectable resistance or viscosity.
3. Aetheric energy can be scooped, directed, focused, flowed, intensified, and in general controlled by geometrical shapes and patterns, and mind or thought (visualization).
4. Aetheric energy is moved and focused around a permanent magnet.
5. Aetheric energy in its myriad forms is the basic life force of the universe and as such is the basis of all the phenomenal universe.

1.8 Bibliography

1. "A Definition of Electric Charge", Paul Stowe, 243 Bentley Court, American Canyon, California, 94589, May 2, 1993.
2. "The Cause of Gravity", Paul Stowe and Barry Mingst, 243 Bentley Court, American Canyon, California, 94589, April 28, 1991.
3. "Spinning Charged Ring Model of Electron Yielding Anomalous Magnetic Moment", David L. Bergman and J. Paul Wesley, Ph.D., *Galilean Electrodynamics*, Sept/Oct 1990.
4. "The Stable Elementary Particles", David L. Bergman, Twin-Cities Creation Conference, July 29-August 1, 1992.
5. Dashed Against the Rock. William J. Colville, Boston: Colby and Rich, 1894. Colville was a close friend of John Keely and this book is a publication of Keely's secrets embedded in a metaphysical novel.
6. "Mass Resonance: Another Secret of Anti-Gravity", Dan A. Davidson and Jerry Decker, *Extraordinary Science*, April-May-June, 1995.
7. Haisch, Rueda, and Puthoff, *Physical Review*, 1994, pages 678-694.
8. Excalibur Briefing. Thomas E. Bearden. Strawberry Hill Press / A Walnut Hill Book, 1980, 1988.
9. Fer-De-Lance: A briefing on Soviet Scalar Electromagnetic Weapons. Thomas E. Bearden. Tesla Book Company, 1986.
10. AIDS: Biological Warfare. Thomas E. Bearden. Tesla Book Company, California, 1988.
11. Divining, the Primary Sense. Herbert Weaver, Routledge & Kegan Paul Ltd., 39 Store Street, London WC1E7DD, 1978.
12. Energy: Breakthroughs To New Free Energy Devices. Dan A. Davidson, RIVAS, P.O. Box 1090, Sierra Vista, Arizona, 85636, 1977.
13. Reichenbach's Letters on Od and Magnetism. F. D. O'Byrne, B.A. (London), 1852, republished by Mokelumne Hill, California, 1964.

CHAPTER 2

BACKGROUND HISTORY OF SHAPE POWER

This chapter summarizes some of the historic researchers of shape power effects and how they used shape to control aetheric energy.

2.1 SHAPE POWER HISTORY

My wife, Jeanine, and I have done many experiments with shape power and various energy shapes over the years. Most of what we did has never been publicly documented until now as there was only a small mention in my previous writings. Shape power has been a recurring topic in our discussions and experiments with universal energy, and it seems to be a recurring theme we find in various sources.

One of our favorites is a famous inventor of the 19th century, John Ernst Worrel Keely, who developed shape power to a fine science. One of Keely's demonstration gimmicks was to draw a series of symbols on a blackboard and one of his vibratory devices or motors would start operating. What I surmise is that Keely used symbols to control the aetheric energies in his lab and possibly focalize them to effect mechanical operation¹. Magic at its finest!

In the book A Dweller On Two Planets², during one of Phylos's incarnations, he was being taken by a Chinese Master, Quong, to a hidden retreat in Mount Shasta. During the trip, the Master demonstrated to Phylos, two occult symbols. Quong drew a symbol he called the *Vis Mortuus* on the ground, which caused a flame of the "fire of life" to blaze up for many feet inside the symbol. The symbol was a circle a couple of feet in diameter with a cross inside the circle and with the cross arms pointing east-west and north-south respectively. The Master Quong threw a stick into the flame and it disappeared. Quong then drew another symbol he termed, *Vis Naturae*, and he stepped into

the flame which proved to be an energizing and rejuvenation aid. The *Vis Naturae* was a circle with a line through the middle running north and south. Subsequent information revealed that the Master was extremely old yet he showed no indication of age deterioration

The ancient Chinese art of Feng Shui ^{3,4} utilizes the placement of houses, household furnishings, building sites, office layouts, etc., to maximize natural energies and place the occupants of the houses and offices in a harmonious, orderly, energetic environment. It is obviously based on shape power effects.

Related to Feng Shui is the ancient I Ching divination system based on the order and placement of the I Ching symbols to foretell the future. The I Ching symbols themselves are shape power devices.

The eye-of-god, a Mexican mandala, is said to focus spiritual energies into the home. It has a basic shape of two or more crossed sticks and is tied in the center. Colored string or yarn is woven around the sticks to create a series of concentric patterns which tend to draw the eye to the center of the mandala. The mandala is said to ward off evil spirits and harmful negative forces.

The Tibetan yogis and Buddhists have an infinitude of mandalas which are claimed to be foci of various gods and spiritual qualities. Additionally, mandalas are also used in meditation to draw in higher spiritual energies and to attune the practitioner to these spiritual forces. Mandalas are designed to tune up a person's energy centers (i.e., the chakras) as there are specific Mandalas for each of the seven major chakras.

The pyramid shape has a rich history of shape power effects ^{5,6,7}. What has been discovered is that the pyramid shape collects, intensifies, and focuses the aetheric or space energy around the pyramid. Many interesting effects have been noted about the pyramid shape, such as the ability to mummify dead animals, fruit, vegetables, and flowers. The pyramid has also been used to sharpen razor blades. The pyramid as a shape power device will be examined in depth in chapter 4.

Another device, the orgone accumulator ⁸ invented by Dr. Wilhelm Reich, uses specific materials to intensify etheric energies and make them useful in physics and biological experimentation and treatment.

It is easy to see that there is more than meets the eye with respect to the effects of shape and what it does in the time-space continuum of our universe.

2.2 JOHN ERNST WORREL KEELY

John Keely was probably one of the greatest enigmas of the 19th century of science. He was labeled an impostor and a Cagliostro by many of his contemporaries and after he died. During his lifetime he demonstrated many advanced technologies which have not been duplicated today and which earned Keely a reputation as one of the great inventors of the age. Keely invented the science of sympathetic vibratory physics. His discoveries in sound vibration alone would fill volumes had they ever been made public. A detailed account of Keely and his scientific achievements is to be found in my first book ⁹, a brief account follows.



Figure 2.2-1 John Keely with the Globe Motor.

2.2.1 Brief History of Keely

John Ernst Worrel Keely was born in 1827 and died on September 3, 1898. Keely's parents died in an epidemic when he was a young boy and he was raised by his grandfather Ernst. Ernst was an accomplished musician, composer, and symphony orchestra conductor. Early on, Ernst recognized that his grandson, John, was a musical prodigy, so musical training became a part of John's life and formed the basis for his discoveries in sympathetic vibratory physics. A career in music did not appeal to the adventurous Keely. Instead, he was impressed by a famous statement by Pagganni, the world renowned violinist, that given the mass chord of a bridge Pagganni could destroy the bridge by playing this note on the violin.

Keely left school when he was a teenager and went off with the circus for a few years; however, his background in music and his intense interest in science caused Keely to settle down and get married. Keely used his background in carpentry to earn a living. Much of his income was spent on experiments in sound vibration.

Circa 1866, while subjecting water to various sound vibrations, Keely had an explosion in his laboratory which wrecked the apparatus. This event was the turning point of his scientific dabbling and for six years of intense experimentation Keely worked to duplicate the effect of converting water to energy with sound vibration. He found that under certain conditions, a frequency of 42,800 vibrations per second would convert water to pure energy. Not steam nor hydrogen and oxygen, but a much more potent higher powered energy, which Keely came to believe was the luminiferous aether, the very energy out of which the universe was formed.

In 1874 a group of investors formed around Keely, the Keely Motor Company, with the expressed intention of exploiting this newfound aetheric force. The company proved to be only a burden to Keely and of no practical assistance in his research. Keely was not a businessman and the affairs of the company did not interest him. As a result the Keely Motor Company was eventually dissolved but not until its founders had exploited its stock for everything they could squeeze out of the company, leaving Keely holding the bag.

During the Keely Motor Company episode, Keely was sustained by a few close friends who understood and believed in the value of his research. Later, Clara Jessup Bloomfield Moore, a wealthy widow, came to Keely's rescue and supported his research until the end of his life. Mrs. Moore wrote the only contemporary biography of Keely and his discoveries².

2.2.2 Keely's Discoveries

Keely's discovery of the dissociation or aetheralization of water by using the ultrasonic frequency of 42,800 was a fantastic discovery just of itself; however, Keely was intent on discovering all the physics behind this phenomena. During his career, Keely used the basic discovery of converting water to pure energy to build many demonstrations utilizing that force to lift huge weights, control the force of gravity by making objects lighter or heavier, propel projectiles, and many others.

The water aetheralization effect was perfected by Keely to the point of being able to break down the atomic nucleus into 27 levels or gradations of finer and finer energies. This is akin to modern physics where they have found numerous subatomic particles which are the building blocks of the nuclear particles such as protons, electrons, and neutrons. Keely claimed that there were countless phenomena associated with each of

these energy levels within the nucleus. Some of these included energies which governed how the brain and mind operated, how gravity was produced, and what the forces were that created electricity and magnetism.

Perhaps one of the most astounding demonstrations was Keely's ability to control the force of gravity. He could make substances either lighter to the point of levitation or make them heavier than their normal weight. As part of his control of gravitational forces, Keely demonstrated a working model of our solar system complete with a simulated sun and planets that was tuned to the actual forces which governed each planet and the sun. This model would even have the simulated sun and planets rotate about their axis and the planets orbit about the simulated sun. Keely controlled this operational solar system with sonic force in conjunction with the aetheric "vapor" released from the breakdown of water. This was demonstrated to Major Richard Sever, an English scientist, in Keely's laboratory during the time of the World Centennial in the late 1890s.

Keely showed that all sympathetic streams of energy are composed of triple currents of vibratory flows. This applies to magnetic, electric, gravital, and brain/mind flows. These laws govern all mass from the innermost subdivision of the atom to the galaxies and universe itself. These flows radiate from suns and stars to planets on down the scale to the very core of the atoms. Since these flows are vibrational in nature and tuned to their respective spheres, Keely believed this was the basis for the term "music of the spheres" used in esoteric writings.

2.2.3 Verification of Keely's Discoveries

At this time there has been little done to verify Keely's overall thesis of sympathetic vibratory physics; however, the dissociation of water using sound vibration has been accomplished, albeit, as an accident in the laboratory. This was explained in great detail in my first book⁹.

The basic experiment involved subjecting water in a quartz tube to ultrasonic frequencies as a test of sonic filtering techniques. The experimenter knew nothing of Keely's work.

John Ernst Worrel Keely (1827-1898) was one of the first in a line of research scientists during the past 100 years who discovered a mechanism to release large quantities of energy with a low energy trigger mechanism. Keely's discoveries hinged on the breakdown of water (and later, other substances) to create what Keely termed "etheric vapor" using specific, tuned, acoustic forces. This obviously fits the free energy definition of a small force (sound in this case) releasing enormous quantities of aetheric force with the source of the energy being matter. This was done in water with a base frequency that Keely

asserted was 42,800 hz (cycles/second). Whether this frequency is accurate is open to debate since a small error in measuring the lower frequency would produce large errors in the higher harmonics and who knows what Keely used for a frequency standard.

Keely generated this ultrasonic frequency using lower frequencies in the audible sound octaves. Ultrasonic and higher frequencies can be produced by taking into account the fact that any vibrating object also produces harmonics of a fundamental tone. By judiciously combining various fundamentals at lower sonic frequencies, Keely could increase the amount of energy being pumped into the higher harmonics since the energy of the harmonics would add vectorially.

2.2.3.1 Duplication of Water Aetherialization

In 1965 an acquaintance of mine, a nuclear chemist, was doing experiments with ultrasonics. The setup is shown in Figure 2.2.3.1-1. The object of the experiment was to set up a standing wave in a column of water and force particulate suspensions in the water to collect at nodal points. The starting frequency for the experiment was 40,000 hz. The power amplifier was outputting approximately 600 watts into a specially built barium titanate transducer fitted to the bottom of a 2 inch quartz tube. When the system was started the water would heat and start boiling off, reducing the water column level in the tube and altering the standing wave conditions. To compensate for this a feedback loop was installed that kept the frequency adjusted so as to keep a standing wave in the column. Thus, the frequency slowly went up as the water level diminished.

At some frequency, a little above 41,300 hz, the water disappeared in the tube. There was no water found from the tube anywhere, it had completely disappeared. A clean hole was found in the ceiling directly above the tube. Further examination revealed that the hole also continued through the roof of the single story building. The conclusion of the chemist was that the water had been converted to pure nuclear energy. He decided that this was definitely not what he wanted to pursue, since conversion of water to pure energy was akin to creating a nuclear bomb, so the whole effort was dropped.

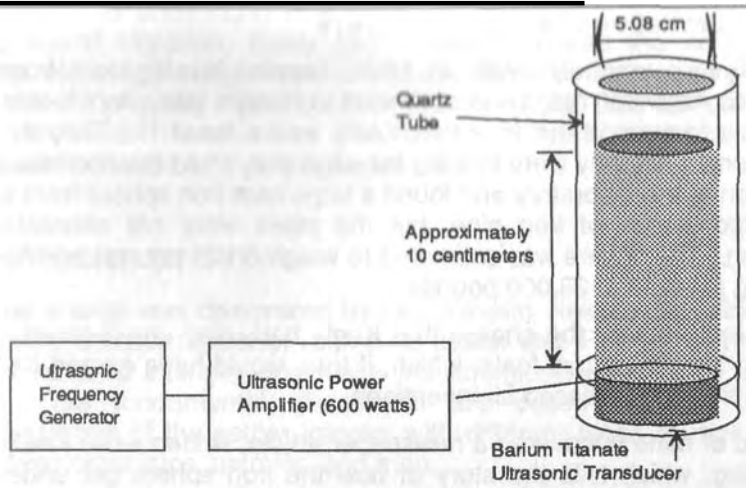

Figure 2.2.3.1-1 Modern Duplication of the Aetheralization of Water

2.2.3.2 Physics of Aetherealization

Analysis of the experiment results in some interesting conclusions. The water column that was used was exactly 3 wavelengths long ¹⁰. This is based on a speed of sound in water of 56,760 inches/second and thus a wavelength of 1.3 inches if we assume the Keely dissociation frequency. Thus the water column of 10 centimeters (3.84 inches) divided by 1.3 yields 3 wavelengths. The net result of this is a standing wave created in the tube. Since the number of wavelengths is an odd number, the reflected wave ends up canceling the primary wave. This results in a stress wave being imposed on the water molecules and the aetheric energy flowing into the nucleus. The result is to set up a vibratory condition that damps out the energy of the nucleus sufficient to cause the atoms to dissolve back into the primordial aether.

One interesting anecdotal story with respect to this experiment has to do with a conference where I was asked to recount the water aetheralization experiment accident. After my talk a crowd of interested members from the audience, who had come up to the podium, were asking me various questions. A young researcher from the back of the crowd caught my attention and said he had duplicated the experiment using a piezoelectric like the chemist used, gotten similar results, and stated that the experiment did not need near as much power as the chemist had used. In the ensuing questions from the crowd, I lost track of the young researcher and was never able to get the details of his duplication effort.

2.2.3.3 Levitation of 4 Ton Iron Sphere

After Keely's untimely death in 1898, several investigators from the *Scientific American* magazine staff went to Keely's laboratory looking for evidence to support the idea that Keely was a fraud. They thought they found what they were looking for when they lifted the floorboards of a section of the laboratory and found a large cast-iron sphere from which protruded pieces of iron pipe, but the pipes were not connected to anything. The sphere was estimated to weigh 6,625 pounds and have a bursting strength of 28,000 pounds.

This event revived the charge that Keely had used compressed air to perform his miraculous feats; which, if true, would have earned Keely a fortune from compressed air inventions.

A friend of mine uncovered a newspaper article, written while Keely was still living, which tells the story of how the iron sphere got under the floorboards. It seems the newsman who wrote the article had gone to see Keely for possible newsworthy information. He found the inventor in his laboratory tearing a large hole in the floor. Keely greeted the reporter but did not seem to be in a talkative mood as he appeared quite busy. After enlarging the hole, Keely attached a strange belt with several mechanisms built into it to his waist. He then attached a thin wire leading from the belt to a large sphere resting in a corner of the laboratory.

After a few minutes of intense concentration by Keely, the ponderous globe slowly lifted a few inches off the floor. Keely then "floated" the iron sphere over the hole in the floorboards and allowed the huge mass to settle to the ground below the floor level. After a few adjustments to the belt mechanism Keely again seemed lost in rapt concentration. This time the globe slowly but inexorably settled itself into the earth, buried by the opposite of levitation; namely, supergravity. Keely had evidently caused the apparent mass of the sphere to increase to such an extent that it sank into the firm earth much as a heavy rock sinks into mud. The inventor told the reporter that he was making room in his lab by clearing away outmoded equipment. This is the sphere later found by the *Scientific American* expose group.

It is theorized that the belt mechanism Keely wore during the levitation feat tuned the atomic structure of the iron sphere so all the atoms were synchronized and aetheric force directed through the sphere caused it to levitate or gravitate.

2.2.4 Summary of Keely's Research

Studying Keely's writings and trying to make sense out of them is a painful process. Keely invented his own vocabulary and it took me

many years to understand in a small part what he had accomplished. Using sound vibration, Keely had literally unlocked the secrets of gravity, electricity, magnetism, sub-atomic physics, brain-mind physics, etc. We will probably never know all that Keely did. We can only hope that more modern researchers who rediscover these secrets will share them with the world for our enlightenment.

2.3 ORGONE ENERGY

Orgone energy was discovered by Dr. Wilhelm Reich. The discovery was really another aspect of universal aether plus Reich's invention of mechanisms to intensify and make the energies available for various uses. His fundamental discoveries are based on how intense manifestations of the aether interact with different types of matter and with living organisms, animals, and man.

2.3.1 Brief History of Wilhelm Reich

Wilhelm Reich was born March 24, 1897, in Austria. His high school education was German and college training was at the University of Vienna from 1918 to 1922 where he finished a 6-year medical degree in only 4 years. His post graduate work was in neuro-psychiatry and internal medicine. Reich was one of Sigmund Freud's star pupils and worked as first clinical assistant for 6 years at Freud's Psychoanalytic Polyclinic from 1924 to 1930. From 1930 to 1933 Reich founded various mental hygiene centers in Austria and Germany. Reich left Austria and Germany for Norway to escape persecution by the Nazis.

Reich discovered orgone energy while he was searching for an energy that was part of neurotic behavior. His breakthrough research in Orgone Physics was started in Oslo, Norway at the Psychological Institute of Oslo University. In 1939, Reich moved his Norway laboratory to Forest Hills, New York where he eventually acquired United States citizenship. Reich was Associate Professor of Medical Psychology in New York City and at his New School for Social Research where he lectured on his discoveries in orgone energy. In 1942 Reich set up his research facility, the Orgone Institute, in Rangely Maine. He termed his new science Orgonomy.

Reich's discoveries led to his testing orgone accumulators on people in hopes it would alleviate their diseases. He had some success in curing cancer and also found that orgone was a good general healing adjunct. For this the US Food and Drug Administration (FDA) went after Reich. They railroaded him into prison, got injunctions against him for using bogus (i.e., non-orthodox) medical treatments, burned Reich's books nationwide, and finally destroyed Reich. The FDA claimed that orgone

simply did not exist regardless of the mountain of evidence Reich had accumulated to prove the existence of orgone.

Eventually Dr. Wilhelm Reich died from all the pressures put upon him by the ruthless FDA only a short time after he was released from prison on the trumped up charges of medical malpractice.

2.3.2 Introduction to Orgone Energy

At first Reich thought that orgone energy was electrical in nature; however, further research and experimentation showed this energy was a totally new type. Because of the association of this new energy with orgasm Reich coined the term "orgone" and believed it was the foundation of life itself. Reich demonstrated that the atmosphere contained orgone and he proved that orgone is the pre-atomic energy from which our universe is made.

One of Reich's most notable achievements was a free energy device based on the fact that high concentrations of orgone would stimulate ionic emission in vacuum tubes.

Table 2.3.2-1 summarizes some very interesting facts about orgone energy. For those familiar with studies of pyramid energy and other aetheric accumulators, it is obvious that orgone is another manifestation or modification of universal aether.

2.3.3 The Oraccu

The orgone accumulator, or oraccu as it was called, is an invention by Reich which will accumulate and intensify orgone energy. Experiments showed that orgone is able to penetrate anything; however, the speed of penetration is different for different materials. Reich found that organic materials such as cotton, wool, wood, and silk readily transmit orgone energy. Metals such as iron and aluminum, on the other hand, will first absorb orgone and then repel it. Within each category (i.e., organic and metal) there were varying degrees of conductivity and absorption. The materials of these two effects form the basis of the oraccu or orgone accumulator.

| Feature of Orgone | Description |
|---------------------------------|--|
| Organic matter attracts Orgone | Natural materials such as wood, cotton, wool, etc. absorb and conduct Orgone easily. |
| Metals repel Orgone | Metals such as gold, iron, tin, etc. will first absorb Orgone and then repel it. |
| Attracted to water | Orgone is very strongly attracted to water and water will readily absorb Orgone. |
| Orgone flows | Layering natural material like cotton then a metal will establish a directional flow of Orgone from the cotton through the metal. Orgone flows from the weaker potential to the stronger, opposite from electricity. |
| Orgone is luminous | Orgone could be seen visually. When a person becomes saturated with Orgone they can usually see the Orgone around the body in a darkened room. |
| Neutralizes radioactivity | When radioactive material is placed in an Orgone accumulator, the material is rendered benign (i.e., non-radioactive) over a period of time. |
| Detectable with an electroscope | This showed the ionic aspect of orgone as it would stimulate the leaves of an electroscope. |
| Would affect a Geiger counter | This is related to the ability of orgone to neutralize radioactivity by stimulating radioactive materials to a higher decay rate causing the material to become benign very quickly. |
| Could affect temperature | Reich claimed that a many layered orgone accumulator would have a higher temperature than the ambient air temperature. My experiments to prove this were unsuccessful. |

Table 2.3.2-1 Facts About Orgone Energy

An oraccu consists of a simple container like a box of 6 sides of any size with the walls of the box made of alternating layers of organic material and metal with the outer layer the organic and the final inner layer the metal. The metal most commonly used was sheet metal. Some metals, like aluminum, Reich considered harmful. Higher powered oraccus had many layers of organic and metal materials. Other shapes than the box were also used such as tubes, but all made use of natural organic and metal layers.

A layering of organic and metallic material would establish a flow direction of the orgone. Orgone would be attracted to the organic, absorbed by it; then absorbed by the metal, and then repelled by the metal. These two processes, running continuously, would draw orgone into the organic side and out the metal side. Thus we can see that with this geometry of materials, orgone flows from weaker potentials to higher potentials. This is opposite of electrical energy which flows from higher to lower potentials. Reichians made a big deal of this as a distinguishing characteristic whereby orgone will flow from lower to higher potentials. However, they ignore the fact that this condition only

occurs in an oraccu with its special shape and material construction or when materials of differing orgone absorption are adjacent.

Environmental conditions would also affect the oraccu. It worked best in dry arid rooms or climates. Moisture, being highly attractive to orgone, would dampen (pun intended) the ability of the oraccu to function at its peak efficiency.

A combined layer of organic and metal formed one "fold" of the oraccu as Reich termed it. The more layers, the higher-powered the oraccu would be; as many layers would create intense concentrations of orgone. Because of this, Reich warned that oraccus with more than three folds should be handled only by a trained medical practitioner.

2.3.4 Constructive Biological Effects of Orgone Energy

Reich and his associates and many followers and experimenters of Reich's ideas have tabulated a host of biological effects of orgone energy. By sitting in an oraccu for an hour or so per day the person gradually becomes saturated with orgone and can begin to see and feel its effects. People describe a prickly glowing feeling when in the oraccu. Warmth and relaxation are common effects. While in an oraccu, and in total darkness, a sensitized person can see the luminous activity of the orgone. Some have experimented and found that orgone is controllable with the mind and feelings.

People have claimed that the oraccu would keep the person more healthy and vital than otherwise. Colds or other ills are claimed to be greatly reduced. Reich claimed that the oraccu appeared to get rid of cancer and other serious diseases. Experimenters and medical personnel have used the oraccu which would enable the orgone to be shot or injected into patients for treatment of wounds, cuts, abrasions, frostbite, and burns with great success.

The oraccu has also been used successfully on pets. Also, the oraccu works well as an incubator for germinating seedlings.

2.3.5 Shape Power and Orgone Energy

The effects of the oraccu as a special materials power device are well documented. A layering of materials which absorb and conduct orgone or aetheric energy is extremely well documented. But what if we combine the shape power effects of special shapes to control and direct the aether with the material effects of the oraccu. A metallic pyramid is much more powerful as a shape power device than a pyramid made of a dielectric non-conductive material.

7.3.6 Dangerous Orgone (DOR) Energy

Reich coined the DOM acronym to describe the negative energies created when radioactive materials (e.g., radium dial watches), harmful chemicals such as insecticides, television sets, and x-ray equipment were placed within the oraccu. The energy produced by putting such devices in an oraccu was to generate an energy as destructive to humans and animals as the oraccu was constructive when used in an environment free of these devices.

Reich and others claimed that DOR formed clouds of dirty dark blots in the sky. DOR is inimical to plants, animals, and man. It takes many days or months, depending on the concentration, for nature to dissipate the DOR and rejuvenate the area.

2.3.7 Summary of Orgone Energy

The main theme is that orgone energy is a condensed form of aetheric energy. The orgone box, with its layering of natural dielectric and conductive materials, collects and intensifies orgone energy so it can be utilized.

Orgone energy stimulates radioactive materials to increase their half life and hence form a possible mechanism to get rid of radioactive waste. Because the orgone box can stimulate radioactive decay, this may be the path to a very simple method of power generation using shape power by utilizing the ion products from the decay. The big clinker in all this is the fact that dangerous orgone (DOR) is created which may be more inimical than the radioactivity itself.

Concentrated orgone energy has potential uses in the health sciences to bring about better, more natural, non-invasive forms of healing and therapy.

2.4 IMPLOSION PHYSICS

An Austrian civil engineer, Viktor Schauberg, is an important link in shape power physics. Schauberg made his discoveries in the early part of the 20th century.

Schauberg became interested in erosion effects during his work as a civil engineer. He noticed that many rivers and streams abounding in the beautiful Austrian Alps were nearly erosion free while man-made waterways needed continual repair due to severe erosion effects. Being a careful observer of nature, he deduced that the meandering of the natural water paths had somehow achieved a state of equilibrium such that the forces of water cause the least damage to the earth through which it flows. From this simple observation and the interesting fact that

trout can remain motionless in a rapidly moving stream, Schauberger concluded that there is a natural force in nature which follows natural pathways. He spent the majority of his life discovering the laws which govern this natural energy. We will probably never know the full extent to which Schauberger developed an understanding of implosion physics since most of the details of his discoveries have been lost.

2.4.1 Brief History of Viktor Schauberger

Viktor Schauberger^{11,9} was born June 30, 1885, in Holzschlag, Vienna Austria, as a guardian of the earth. He was born into a family of "woodsmen" or forest wardens whose duty was to oversee a section of the mountains and forests in Austria. Their motto was "*Fidus in Silvis Silentibus*" ("faithful to the silent forests").

From childhood, Viktor was at home in the forest. He was a close observer of nature, the animals, earth, trees, and waters. Water was to become his lifelong passion and he determined, at an early age, to discover the laws and secrets of water. Schauberger saw water as a living substance filled with life and life's energies.

When Viktor reached adulthood, he naturally went into the service of the government, working for a local prince, a large landowner, as a forest warden. Near the end of WWI he had earned a position of responsibility over a large wilderness area. The prince, in need of money, contracted to lumber companies to log the wilderness area. A literal logjam occurred when the lumber companies could not get the logs out of the mountains due to inadequate water supply to float the logs to the lumber mills. Viktor devised special flumes based on natural water pathways (i.e., spiral and meandering paths) which required minimal water to float logs to the mills. This enabled the logging of areas previously inaccessible to lumbering interests.

The despoiling of the forests with over logging and the concomitant effects of ecological destruction caused Viktor to resign in disgust over the greedy, short-sighted, commercial interests.

Schauberger pursued private research. His first development was a machine which would provide good drinking water that was alive with natural vital energy. This was an egg shaped container which had a small impeller in the bottom of the container. The impeller would spin at high speed and cause the water to form into a natural vortex (i.e., a three dimensional spiral) pattern. Viktor had discovered that when water or any other fluid or gas was spun in a vortex it would pick up an energy charge.

Laboratory experiments by myself and others have shown that water spun in a vortex will acquire an electrostatic charge. Voltages up to 10,000 volts have been measured at the center of water which has been

vortexed for several minutes. Similarly, in a tornado, huge electrostatic forces are generated amounting to many millions of volts.

One of Schauberger's discoveries related to his development of the special log flumes was the construction of natural water guides that would keep harbors and rivers from of silt build-up. Viktor discovered that by proper design of water channels an engineer could either build up the river bottoms or cause them to be dug out and kept free of silt.

By 1930, Schauberger had developed anti-gravity machines which could fly much higher and faster than any known aircraft of the day and developed free energy devices which achieved tremendously higher output power than input power. The gravity machines resembled flying saucers or unidentified flying objects (UFO) seen and documented by thousands of observers in the past 60 years. A couple of these craft are shown in Figure 2.4.1-1.

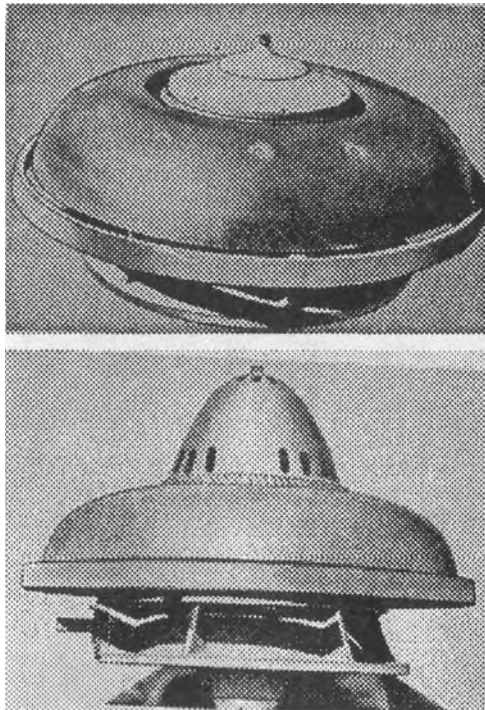

Figure 2.4.1-1 Two of Schauberger's Levitation Craft Built for Nazis in WWII.

In 1934, Viktor was "requested" to meet with Hitler ¹³. Hitler offered Schauberger a job as a scientist developing aircraft based on the anti-

gravity discoveries. When Schauberger refused, Hitler put Viktor's family in a prison camp which forced Viktor to work on his inventions for Hitler. Viktor worked for the third Reich on anti-gravity craft from 1938 to 1945, the end of WWII.

When the Allied forces took over Germany, the Army Intelligence Corp discovered Schauberger's research, including several unfinished disc craft. This brought a new peril to Schauberger in the form of "vested interests" who did not want free energy technology to be released for public use.

Agents of the vested interest group contacted Schauberger and contracted for him to build one of the free energy turbines, the Zokwendle. The Zokwendle was designed to provide 50,000 Watts of cold diamagnetic power and 50,000 watts of normal electricity. The Zokwendle was shipped to New York and American scientists could not understand the machine nor could they get it to operate since they tried to make it work based on current physics instead of following Viktor's directions in its operation. The Zokwendle is shown in figure 2.4.1-2.

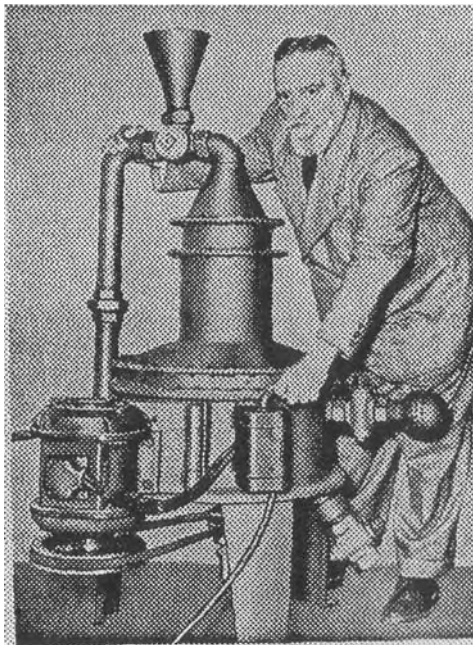

Figure 2.4.1 -2 Schauberger Next to His Zokwendle

As a result Viktor was brought to the United States to get the device operating; however, he discovered that the group had no intention of

letting him release free energy to the world so Viktor refused to help. Schauberger was threatened with prison and forced to sign over full ownership of his Zokwendle to the vested interests. He returned to Germany, a broken man, and died several months later.

2.5 Summary of Implosion Physics

Viktor Schauberger discovered a universal energy which was the opposite from normal electricity, it existed everywhere, and was the basic foundation of life and substance. Basically, Viktor re-discovered the aether as diamagnetism, the same as Reich had discovered the aether as Orgone energy. Diamagnetism was conducted by non-conductors; hence, the reason he called it diamagnetism after the scientific term for a non-conductor (i.e., diamagnetic).

Schauberger also discovered that diamagnetism, or the aether, would follow spiral and vortical pathways and that these types of pathways would act as concentrators of diamagnetism. By forcing fluids to move in special vortex guides he could cause the fluid to be charged with diamagnetism which in turn would cause the atoms of the fluids to collect an electrostatic charge.

Gravity was also found to be related to diamagnetism. By moving the aether in a vortical pattern, matter within the vortex would lose weight and levitate. This effect was the basis of his disc flying machines. Schauberger experimented with various hydrodynamic fluids such as water, air, and sand as the basis for the material he ran through his levitation motors.

Healthful life-giving effects were also discovered to be associated with diamagnetism. Viktor found that when foods and beverages were charged with diamagnetism they improved a person's health.

2.6 Bibliography

1. Keely and His Discoveries. Clara Bloomfield Moore, London, Kegan Paul, Trench, Trubner & CO, Ltd., 1893.
2. A Dweller on Two Planets. Phylos, Borden Publishing Company, Los Angeles, 1952.
3. Feng Shui the Science of Sacred Landscape in Old China. Ernest J. Eitel, Synergetic Press, Tucson, Arizona, 1984.
4. Interior Design With Feng Shui. Sarah Rossbach, E.P. Dutton a division of NAL Penguin Inc, 2 Park Avenue, New York, N.Y. 10016
5. Great Pyramid Proof Of God. George R. Riffert, Destiny Publishers, Merrimac, Mass., 1932.
6. Pyramid Power. Max Toth and Greg Nielson, Freeway Press, 1974.
7. The Guide To Pyramid Energy. Bill Kerrel and Kathy Gorggin, Pyramid Power V, Inc, 1975.
8. New Light On Therapeutic Energies. Mark L. Gallert, James Clarke & Co. Ltd, 31 Queen Anne's Gate, London, S.W. 1, 1966.
9. Energy: Breakthroughs To New Free Energy Devices. Dan A. Davidson, RIVAS, P.O. Box 1090, Sierra Vista, Arizona 85636, 1977.
10. T-Field Energy Research. Dan A. Davidson, RIVAS, P.O. Box 1090, Sierra Vista, Arizona 85636, 1990.
11. Center Of The Vortex. William F. Hamilton, Telos Publishing Co., P.O. Box 1745, Sun Valley, CA., 91352, 1979, 1986.
12. "Investigations at the Keely Laboratory", *Scientific American*, February 4, 1899, 72-73,
13. Weltreich Spirale. Leopold Brandstatter, Linz/Donan, Austria, Morikeweg 3 Branstadart, 1961, 1962.

CHAPTER 3

EARTH ENERGIES

3.1 Earth Energies

A new awareness of earth energies emerged in the 1920's when German dowsers found there were houses where people got more cancer than their neighbors. Physical analysis and dowsing analysis found underground veins of water crossing under the cancer houses, and not under their neighbors' houses. Underground waterways that cross one above the other generate a vortexing energy in the aetheric field which seems to affect people's health. Researchers have even found that trees growing over one of these spiral energy points will be affected by the vortexing energy and grow in a twisted pattern.

About that same time, Alfred Watkins of Herefordshire, England, made the interesting discovery that many of the ancient holy sites lined up in straight lines. He called these "leys" or ley lines. He theorized that the ancient people from the Neolithic and into the Christian era located their holy sites on these ley lines. Dowsing revealed that these ley lines are part of the Earth's energy system.

3.2 Ley-Lines

Ley lines are another manifestation of aetheric energy. Ley lines originate above the earth's surface; penetrate and leave the Earth vertically at nodal points or "power centers" as dowsers call them. Ley lines are aetheric energy flows over the surface of the earth and are conduits for feeding the earth with aetheric energy.

Ley lines vary from only a few feet to many thousands of miles long.¹ Leys which emerge from the earth are termed "yang" or positive in polarity and act to stimulate a person. Conversely, leys which enter the earth are "yin" or negative in polarity and will enervate a person.

It was found that most (i.e., about 70%) of the yang energy points of ley lines have water springs associated with them. Experimental evidence shows that water is attracted to aetheric energy so it is natural that ley lines are frequently associated with water.

Rivers, mountains and other natural and man-made structures influence ley-lines and cause the energy flow intensity to become stronger or weaker. So we can see that if ley lines are influenced by natural and man-made structures then the leys can be controlled and the energy manipulated.

Those with their inner sight can sometimes see the ley lines under special conditions. Dowzers (i.e., motor sensitives) readily detect them with dowsing instruments such as rods, aura meters, etc.

3.3 Energy Grids

According to dowzers there are several types of grids which vary in size and distance above the earth. These are east-west/north-south energy grids that form a natural energy system which covers the entire earth. The Curry Net and the Hartmann Net are the two most well known of the earth grids. Recent research by Bruce Cathie, a New Zealander, has also discovered an energy grid which appears related to UFOs.

Dr. Manfred Curry¹ discovered the grid named after him. The Curry grid, depicted in figure 3.3-1, is very regular, stable and covers the entire earth. Its lines run in an approximate northeast-southwest/northwest-southeast direction and is thus running at a diagonal to the latitude and longitude directions. It is believed that the Curry Net is of earth origin. It has alternate charging and discharging nodes. The lines are 10-12 feet apart in the northern and southern hemispheres and 12-15 feet apart as they get closer to the equator.

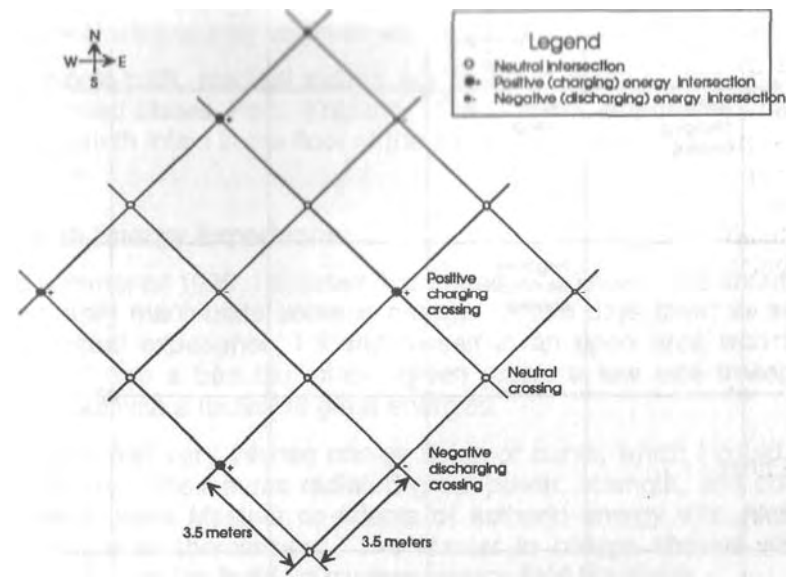

Figure 3.3-1 Curry Net Earth Grid

The other well-known grid is the Hartmann Net¹, shown in figure 3.3-2, which runs north-south/east-west. It is believed to be of cosmic origin and is not as stable as the Curry Net. According to dowsers the Hartmann Net has a phase change four times a day: at sunrise, noon, sunset, and midnight. During these phase changes, the grid disappears. It seems to be influenced by cosmic or astrophysical activity such as moon phases, sunspot activity, and weather conditions.

The east-west grid lines intersect the north-south grid lines and form vortices. Depending on location and size of the grid line, the vortex can be either an ascending or descending flow of aetheric energy. Dowsers believe that these vortex points of the grids can be either harmful or helpful to a person's health.

The Cathie grid is supposedly similar to the Hartmann Net but the Cathie grid is made of rectangles that are 45 nautical miles square. Cathie believes the grid spacing is related to gravity, the speed of light, the mass of the earth and other natural earth constants. Bruce Cathie's research points to UFOs traveling on this grid system.

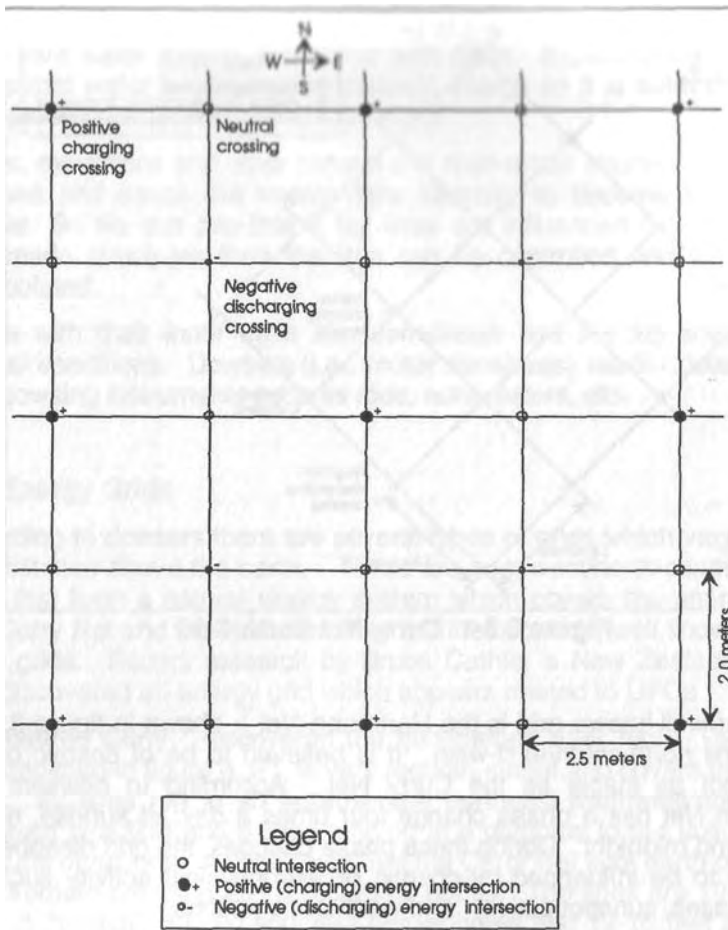

Figure 3.3-2 Hartmann Net Earth Grid

3.4 Ancient Shape Power Use of Earth Energies

Some Indian tribes in Southwestern United States used shape power in conjunction with earth energies to collect and focus earth energy in and around their dwellings, and their ceremonial buildings called kivas. Kivas act as a magnetic center to draw energies from the surrounding area and refocus them out the top center of the kiva.

Another ancient shape power pattern is the labyrinth. A labyrinth is a single-path, two dimensional maze. There are left and right handed labyrinths. Direction of the labyrinth *maze* determines the type of energy which it focuses. The esoteric function of the maze is to guide the person through the shape power pattern and tune them into the energies associated with the pattern. Its other obvious function is to

channel earth energy. Most labyrinths create clockwise and counterclockwise energy vortexes with subtle differences and effects.

These single-path, magical mazes are found in many places, such as China, United States, Peru, England. The Gothic Cathedral at Chartres has a labyrinth inlaid in the floor of the nave.

3.5 Earth Energy Experience

In the summer of 1995, I decided that I needed to know more about how to personally manipulate aetheric energy. A few days later, in a very vivid spiritual experience, I found myself in an open area with three Beings. It was a beautiful place, green grass, a few nice trees, and peaceful but with a feeling of great energies.

The Beings had very intense energy fields or auras, which I could both see and feel. Their auras radiated great power, strength, and control. The Beings were Masters or Adepts of aetheric energy who had first totally mastered themselves. The Master in charge showed me an energy movement to build up my own energy field like theirs.

I have had three more of these experiences since the first one in 1995, so there are a total of four movements, each designed for a specific purpose but all under the general category of personal control and use of various aspects of universal energy. (These movements are described in detail in Appendix A.)

During the first experience, the head man of the team imparted to me that there was an intense energy field close to the ground. I could sense/feel this energy above the surface of the ground during the experience, and have since proved that I can also sense its level while awake. This energy field is green, 6-18 inches high, and flows in waves from south to north. The waves have tremendous amounts of energy.

3.5.1 Initial Tests With Clairvoyants

In August of 1995, I conducted tests with clairvoyants and clairsentients (sensitives) to get more information to corroborate my experience; namely, is there some type of energy field near the earth and what are its characteristics? These first tests were conducted without telling the sensitives of my experience or of the energy field. They were asked to examine the higher/finer energy levels near the earth's surface and determine what they could sense/see.

Results from the tests with the sensitives are as follows:

- There is an apple green colored energy field at the surface of the earth with waves going through this energy field.

The energy color was close to the color of a Granny Smith apple. Clairvoyants said the green energy was difficult to see in bright light but easy to feel.

- The energy varies from 6 to 36 inches in height above the surface of the earth.
- The waves move from south to north.
- The wave crests are 15 - 18 inches apart and the peak of the waves was about 4 - 5 inches in amplitude. The waves go along for a small distance of 3 or 4 feet and then break up into a series of shorter (i.e., higher frequency) waves with the same amplitude. There may be breaks in the flow between the larger and smaller waves but this was not verified.
- Visual detection was most easy in early morning at dawn or just before sunset in the evening.
- Clairsentients experienced no difficulty in feeling the level of the energy.
- There is a huge amount of energy in the waves and the energy is actually moving like the energy moves in an ocean wave.
- Weather conditions such as wind do not affect the green energy flow.
- The green energy field is not the same as the earth grids.

After the tests with sensitives to sense the green energy field, I then informed them of the scooping movement which I had been shown. Visual (i.e., clairvoyant) tests after demonstrating the Scoop movement showed my aura going from a normal energy level to a brilliant white light radiating all through my auric field and forming an ovoid of white light around me about 4 feet thick around my physical body.

In all my research, I have never run across any description of a flowing field of green energy at the surface of the earth. The green energy goes from a minimum of 6 inches to a maximum of three feet above the earth's surface depending on time of day and local environmental conditions. The fact that the field goes from south to north indicates a possible magnetic or polar connection with the green energy.

3.5.2 Substance Transmissibility Tests to Green Energy

I was interested in the transmissibility of various substances to the aetheric green energy. Dr. Wilhelm Reich's orgone energy research led to the fact that metals and natural material conduct orgone differently. Experiments with sensitives were conducted to determine how various

materials conduct and interact with the green energy. Results from the analysis are annotated in table 3.5.2-1.

It is very interesting to note that the experiments with pyramids show that pyramids are not affected by the green energy and do not interact with it. This probably means that pyramids operate on a different aspect of aetheric energy which has little or nothing to do with the green energy field.

| Material | Conductivity to Green Energy |
|---------------------------------|---|
| rocks | Goes through as if not there |
| glass (lead crystal) | Goes through w/ slight resistance, almost a trepidation |
| PVC pipe | Did not pass through at all |
| pyramids (cardboard and copper) | Circulated through pyramids and did not interact with the pyramids |
| person | Disturbed the energy and moves around legs and feet and hugs onto them in an almost loving manner |
| wood | Goes through as if not there |

Table 3.5.2-1 Green Energy Transmission Through Various Materials

One of the more interesting aspects of transmissibility is the fact that the green energy field does not pass through plastic. For some reason, not only does the green energy not pass through plastic but we found that a person's aura does not pass through plastic. Related to this is the fact that synthetic fabrics block the flow of a person's aura while natural fabrics readily pass or conduct the auric energies.

Natural clothing materials, such as cotton, silk, wool, and leather, all readily conduct auric and other aetheric energies. Fabrics such as polyester and acrylics all block aetheric flows. For this reason, I recommend that people quit wearing clothing made of these synthetic materials as they hamper the natural energy flows around a person wearing them. It is also good to use bed sheets and sleep clothing and bed covers that are made out of only natural fabrics such as cotton, linen, wool, and silk.

3.5.3 Earth's Aetheric Energy Grid

Discussions with Niena this morning reminded me of some early (i.e., circa 1968) work on free energy. Niena has seen a matrix of energy on several occasions surrounding her. It is a 3-D cubic matrix with small points of light less than an inch apart in parallel rows and parallel planes, forming a three dimensional energy grid. This points to a grid of energy covering the earth as written about by dowsers and Bruce Cathie. It is probably caused by standing waves in the aetheric field with a wavelength the distance between points. This may point to a mechanism for tapping the field with a shape power device. Bruce Cathie claims to have discovered an earth grid which UFOs use to travel on (i.e., the UFOs travel on grid lines). Chapter 7 discusses Joe Parr's centrifuge experiments related to galactic energy grids. Joe got the best results in certain locations in the laboratory and he postulated the possibility of an earth grid line running through his lab. When the world renowned dowser, Bill Cox, dowsed Joe's lab, he said Joe's experiment was right on a major grid line.

3.6 Pranayama, Chi Gung and Tai Chi Exercises

The yogis of the Far East, as well as those in the western world who have learned their techniques, have developed breathing and postures (exercises) which enable a person to learn total control of all bodily functions and bring the body into a state of perfect health. These exercises are designed to charge the body with energy that the Hindus call prana, their word for universal energy. The breathing exercises are generically termed "pranayamas" meaning little prana exercises. The fantastic feats of advanced yogis are well documented. These feats are all the result of learning control of prana.

Chi Gung exercises also are designed to enable a person to master the chi forces for both health and protection (i.e., the martial arts). Chi Gung masters are able to effect remarkable control over their bodies and eliminate very serious disease conditions and rebuild the body to total vibrant health.

The Chinese have developed numerous exercises which enable a person to control their own chi (also Ki) or life energy. The Tai Chi movements are designed to increase a person's chi and give a person control over this energy. The very advanced marital arts masters are able to use their control of the chi forces to protect themselves from attacking adversaries.

3.7 Feng-Shui, a Chinese Method of Chi Control

Feng-Shui is both an art and a method of understanding nature and the universe. Analysis of the Chinese art of Feng-Shui shows that it has mechanisms for controlling chi or aetheric force by utilizing shape, location, landscape, and placement of objects to maximize or minimize the local chi or aetheric forces. The Feng-Shui masters, adept at the art, are able to utilize its rules as well as use divination to effect maximum control of situations, maximize health, effect longevity, protect homes and businesses from negative force and events, etc.

Feng-Shui is based on 1) "Li" roughly translated as the laws of nature, 2) "Su" or the numerical proportions of nature, 3) the breath of nature, the yin and yang, the dragon and the tiger, or the positive and negative energies, and 4) nature's appearance and forms. It is in this latter aspect of Feng-Shui that we see how form and shape are viewed and utilized in Feng-Shui to control the chi.

If the reader's interest is piqued by this short explanation, I would recommend reading some of the books listed in the bibliography for a more complete understanding of this ancient art. Its many heuristic rules and mechanisms are much too extensive to include here.

3.8 Summary of Earth Energies

There is obviously much that we do not know of our natural environment. Energy grids, aetheric flows, power centers, geopathic zones, and green energy flows are all various manifestations of aetheric forces and their interaction with the environment and us. The theme of how different materials interact with these natural forces comes up time and again in research done by scientists studying our marvelous universe. It is also becoming obvious that many of the materials and technologies we have developed are not in harmony with the way these natural forces operate. Many synthetic materials block the flow of the natural forces and isolate us from their health-giving aspects.

This leads to another area of research to be pursued; namely, the fact that aetheric forces interact differently with different materials will lead to inventions which utilize the combination of these effects.

It is highly significant that we can do exercises, establish our residence in proper locations, and adjust our clothing, home and work environment to enhance our absorption of these natural forces and energies.

3.9 Bibliography

1. Crop Circles: Harbingers of World Change. Alick Bartholomeu, Gateway, Bathe, UK, 1991.
2. Feng-Shui the Science of Sacred Landscape in Old China. Ernest J. Eitel, Synergetic Press, Tucson, Arizona, 1984.
4. Interior Design With Feng-Shui. Sarah Rossbach, E.P. Dutton, a division of NAL Penguin Inc, 2 Park Avenue, New York, N.Y.
5. Dawn Behind the Dawn: A Search for Earthly Paradise Geoffrey Ashe, New York: A John Macrae book, Henry Holt and Company, 1992
6. A Quest For the Beginning and the End. Graham Hancock, Gerald Hawkins, New York: A Delta Book, 1965.
7. Divining, the Primary Sense. Herbert Weaver, Routledge & Kegan Paul Ltd., 39 Store Street, London WC1E 7DD, 1978.

CHAPTER 4

PYRAMID ENERGY

4.1 Introduction to the Pyramid

The pyramids in Egypt are one of the seven wonders of the ancient world and the only one left standing. There are a number of pyramids in Egypt as well as in other parts of the world. Most of them are step pyramids made of successive layers of some building material, usually stone. The three most well known are the three pyramids on the Giza plateau just outside of Cairo. Of these, the Great Pyramid has been studied and analyzed the most and has had an impressive amount of research done on it. On appearance, the great pyramid is another step pyramid; however, at one time it was covered with white limestone to form a smooth concave surface on each of its four sides. When the pyramid was first created, the basic material of the great pyramid was granite with a white limestone casing.

Table 4.1-1 summarizes some very interesting facts about the great pyramid. The great pyramid is an anomaly in time and space, since it embodies scientific facts not discovered until many thousands of years after it was first constructed.

| Feature | Value | Great Pyramid feature | Description |
|-----------------------------------|----------------------------|---|---|
| Weight of earth | 5.3×10^9 tons | Weight of great pyramid is 5,300,000,000 tons or 15 orders of magnitude of the earth's weight | Estimated weight of the earth in tons |
| Sidereal year | 365.2564 days | Designer's base circuit of pyramid in pyramid inches | Astronomical time in days between two sightings of the same star before and after the earth's orbit around the sun. |
| Anomalistic year | 365.2599 days | True base plan design of pyramid. | Astronomical time in days of the earth's orbit around the sun. |
| Solar year | 365.24 days | Length of each true base side is based on the sacred Hebrew cubit. | Succession in days from one autumnal equinox to next |
| Processional cycle | Approximately 27,000 years | Great pyramid gives all processional rates for 6,000 years while modern astronomy knows them for only 400 years | Time to precess the equinoxes |
| Pi | 3.1415... | Repeated in many places throughout the great pyramid | Ratio of circumference of a circle to its diameter |
| Sun's distance to earth (average) | 92,900,000 miles | After some computation built into great pyramid as 92,996,085 miles | Average distance of earth to sun during its yearly orbit |
| Location | Giza Plateau in Egypt | Geocentric center of earth's land mass | Control location with respect to rest of the earth's land mass. |
| Masonry accuracy | 1/100 inch | Gigantic 10-30 ton granite blocks placed accurately to within 0.01 inch. | Accuracy of placement of gigantic granite stones |
| Phi | $(1+\text{SQRT}(5))/2$ | Great Pyramid has a base to height ratio | Phi is a naturally occurring number in geometry and other branches of mathematics |

Table 4.1-1 Some Interesting Facts About the Great Pyramid

4.2 Great Pyramid Was NOT a Tomb

The great pyramid was never built or used as a tomb for some Egyptian royalty or anyone else. Nothing was ever found in the pyramid resembling Egyptian tombs. The pyramid was built with air passages, no tomb or other pyramid was built with air passages for the dead to breathe. The granite plug, a block 15 feet long, which was at the beginning of the ascending passage, was placed there when the construction reached that level.

Speculation abounds as to the great pyramid's true function. Orthodox Egyptologists cling to the belief that the great pyramid was used as a tomb for Cheops, the Egyptian king during whose reign the pyramid was supposedly built. The Rosicrucian Society believes that the pyramid was used as an initiation chamber to test advanced adepts. Some believe that it is an interstellar beacon to guide alien spacecraft to planet earth. Whatever the great pyramid is, it is NOT a tomb nor has it ever been. As a minimum, it is a testimony that advanced technology existed on the earth, rivaling our own, over 6000 year ago. A recent test case by Japanese scientists to duplicate the effort with modern construction technology and engineering failed.

4.3 Mathematical Relationship of the Great Pyramid

The Great Pyramid has a base to height ratio of 2 to $\text{SQRT}(\text{Phi} - \text{fi})$, where Phi is the Golden Ratio and is equal to $(1 + \text{SQRT}(5))/2$. Phi is a transcendental number in that it is a non-terminating decimal. Because of this, Phi, from a resonance point of view, would have an infinite number of harmonic resonance points. Resonance is a key factor in all areas of physics, including nuclear physics, quantum mechanics, electrical engineering, antenna design, etc. Phi is also related to the Fibonacci series where each succeeding number is formed by the formula $N_{i+1} = N_i + N_{i-1}$. For example if the first starting number is a 1 then the Fibonacci series is:

1, 2, 3, 5, 8, 13, 21, etc.

If we take the mathematical limit on the ratio of N_{i+1}/N_i then that ratio is Phi.

Phylotaxis is the tendency of growth processes in nature (e.g., plants and sea shells) to grow in spiral patterns. It has been observed that plant leaves and branches grow in spirals where the ratio of the amount of turn from one branch to the next forms a Fibonacci series and hence to Phi. So we see that the great pyramid was designed to be resonant to natural forces in nature.

4.4 Pyramid Energy

Probably one of the most interesting aspects of pyramids is the ability of a pyramid to concentrate and focus aetheric forces. During the 1960s and 1970s there was a great flurry of pyramid energy research and quite a large body of information on pyramid energy experiments was published. Table 4.4-1 summarizes some of these very interesting energetic facts about pyramids.

| Feature | Pyramid Energy Effect |
|--------------------------------|--|
| Preserves Food | Experiments showed that foods would last longer while placed inside a pyramid shape. |
| Enhances Meditation | Habitual meditators claim that meditation in a pyramid shape enhances the meditation process and one can achieve heightened psychological effects. |
| Promotes Healing | Wounds of people and animals appear to heal faster and with fewer problems when the subject is treated in a pyramid shape. |
| Only pyramid shape is required | Extensive experiments have shown that only the outline (i.e., the edges) of the pyramid are necessary to get the pyramid energy effects. |
| Generates static electricity | Experiments both at the Great Pyramid and here in the USA indicate that the pyramid may be some sort of generator of static electricity. This effect seems most pronounced for very large pyramids so it may be strictly an electrostatic effect of a tall object picking up some earth ES effect due to height. |

Table 4.4-1 Pyramid Energy Effects

Of all the above interesting effects, the most profound is the fact that all the pyramid energy effects can be generated with only the barest of outlines of the pyramid shape itself. In fact, research has shown that a certain amount of open space is necessary in the sides and bottom of the pyramid to enhance the energy effects. Maximal energy effects are achieved with only the open frame. The books in the bibliography at the end of this chapter contain a wealth of information on the various aspects of the pyramid. Many researchers became interested in pyramid energy and furthered the understanding of the effects associated with pyramid energy. One of the better known of these researchers was Patrick Flannigan^{5,6} who developed instrumentation to test the effects of pyramid energy.

4.5 Pyramid Energy Research Summary

In some of my experiments during the 1960's, I showed that pyramidal shapes seem to generate an electrostatic energy or at least collect an electrostatic charge. In more recent experiments in the 1990's, I proved

that a small copper pyramid made from copper sheeting builds up a slight charge. Maximum charge generation seems to be when aligned north-south/east-west. I theorize that the pyramid shape interacts with aether flow east-west and magnetic field north-south, resulting in a vortex action up the sides of the pyramid which culminates in electrons being produced, as in the Les Brown experiment described in a subsequent section. More measurements need to be taken to verify generation rate, etc. Measurement of the ES field is with my ES field meter. It is low power, about like running a comb through the hair and the pyramid takes about 30 seconds to build up.

Experiments with some of my two inch pyramids made of plastic and also a large one made of cardboard and a smaller one of copper sheet yielded some corroborative information. Most of the following points were worked out many years ago and tests with clairvoyants correlate precisely with all the research that I and others have done on pyramid energy. However, some new shape power effects crop up here.

1. Energy flows up the sides of the pyramid and comes off the peak as a spiraling pillar of light.
2. Maximum energy off the peak is obtained when opposite faces of the pyramid are oriented in a north-south direction.
3. A magnet on each side of the pyramid greatly intensifies the field off the peak of the pyramid. Magnets need to be lined up so the field across the pyramid is attracting (i.e., NS - SN). The pyramid product which I designed many years ago had small magnets embedded in the pyramids to make the energy field stronger.
4. A copper pyramid works much better than the plastic or cardboard pyramids. We knew that materials were important but not which materials. A single copper pyramid lined up to the earth's magnetic field is equivalent to a plastic pyramid with magnets on each side to intensify the field. Maximum energy collection occurs when the pyramid and magnets are lined up with the earth's magnetic field. This means the copper pyramid is several thousand times more powerful in focusing aetheric force than a pyramid made of dielectric materials.
5. Pyramids drawn on paper or chalk board (i.e., 2-D drawings of 3-D pyramids) have the same energy as the 3-D version. This may be a trick of the vision in that the viewer is visualizing a 3-D object. Visualization, as Niena and I found out many years ago, of pyramids will focus the energy as if the pyramid was physically there. Visualizing a pyramid shape over a locality actually focuses the pyramid energies in that locality.
6. Painting a couple of the plastic pyramids with aluminum paint did nothing to modify the amount of energy coming off the pyramids. It

was thought that metalizing the surface would help the energy production since the copper pyramid seemed more energetic than the plastic ones. Perhaps the paint color should have been copper with copper particles in the paint.

7. The pyramid shape generates a magnetic field due to the sides meeting at points at the top and corners. See chapter 1 of this book.

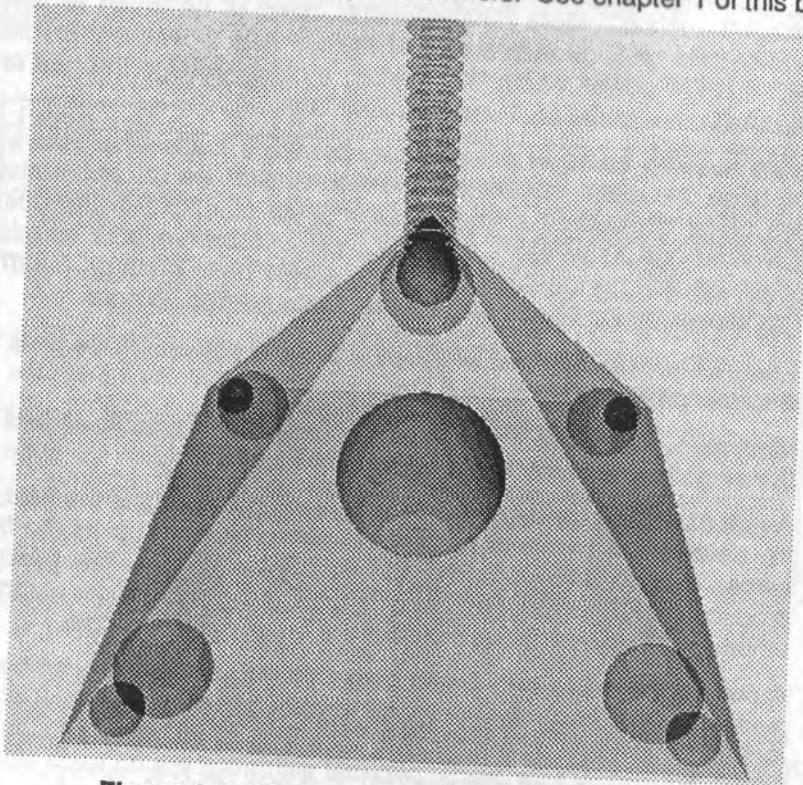

Figure 4.5-1 Pyramid Energy Concentrations.

4.6 Copper Pyramids Experiment

I built four copper pyramids from some sheet copper. The pyramids are two inches at the base and the sides are equilateral triangles. The pyramids are placed to form a square array of two rows and two columns which is aligned with the earth's magnetic field. Neodymium magnets are placed on opposite ends of the array and the array and magnets are aligned with the earth's magnetic field. As a comparison, I also laid out four plastic pyramids in a similar array. Both sets of pyramid arrays were set on the ground outside the laboratory so they would be in the energy field that flows over the earth's surface.

Tests were done to find out what was happening with the energy fields around the pyramid arrays. Results showed that the copper array has much more energy radiating off of it than the plastic array. Even with magnets on the plastic array and none on the copper array, the copper pyramids had more energy.

In the copper array, the energy was concentrated off the peaks of the pyramids and between the pyramids in the north-south direction.

From all of this we can deduce that metals (i.e., conductors), in general, deflect and focus pyramid energy and non-conductors such as plastic absorb and conduct the energy. Similar materials effects are discussed in chapter 3 on orgone energy. The pyramid energy is enhanced when the array is within a magnetic field and the stronger the field the more energy is converted. This requires that the whole array including the magnets be aligned with respect to north-south/east-west and the earth's magnetic field.

4.7 Electrostatic Power Generation

Over the years, a number of experiments and observations have shown that the pyramid seems to be a generator of electrostatic energy. This probably means that the pyramid is a converter of aetheric energy directly into electrical energy; however, when one realizes that electrostatic fields are the result of differing concentrations of aetheric energy then this is not so surprising.

4.7.1 Les Brown's Shocking Experience

A video I have by the late Canadian crystal researcher, Les Brown, tells of a huge charge of power he got from a large 30 foot pyramid which he built (See figure 4.7.1-1). He put a counterclockwise (CCW), vortex shaped, copper stove wire (with frayed ends) at the top, on the inside, of his big 30-foot pyramid to act as an antenna/collector. At the bottom of the pyramid he affixed a wire to a piece of 1/4" plywood wound in a clockwise (CW) flat spiral establishing the ground antenna. The center of the wire spiral was put through the plywood and grounded. The outer end of the flat spiral stuck up in the air so it could be attached to the wool thread coming from above. Two inch staples went through the ground coil, and through the plywood further grounding the coil. From the apex antenna, he affixed a pure lamb's wool thread and dropped it down the center of the large pyramid. When he went to connect the thread to the spiral at the bottom of the pyramid, a high voltage charge (or whatever type of energy he had connected with) knocked him twenty feet across the floor inside of the pyramid into the wall. This scared him so badly he took the whole thing apart and did nothing else with it.

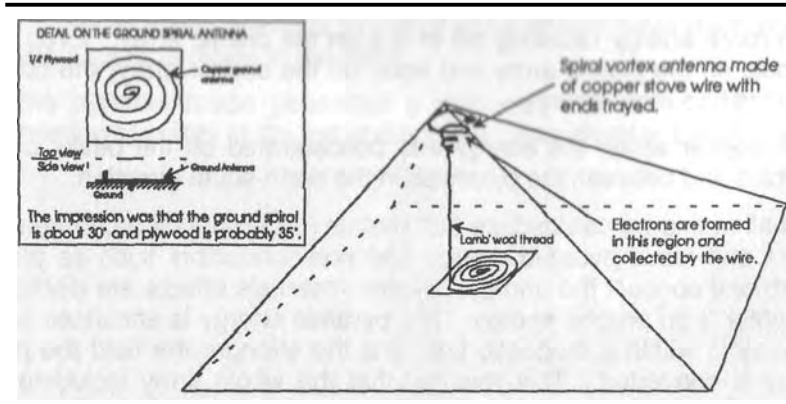

Figure 4.7.1-1 Les Brown's Pyramid Energy experiment

4.7.2 Spiral Energy off Apex of Pyramid

A number of years ago, Jerry Decker, prominent new science researcher, attended a Crystal Symposium in Irving, Texas, hosted by Priscilla Boyd, now in Hunstville. Mary and Dean Hardy of Allegan, Michigan, presented material on research they had been doing with pyramid energy. They showed a photographic slide of a pyramid emitting a double helix beam of energy when excited by a Tesla coil.

A scanned-in image of the original photo, figure 4.7.2-1, was taken by Dr. J. D. Nelson of the University of Wyoming. From the limited information we have concerning how it was done, the pyramid shape is made of soldered copper sheet, possibly with a crystal placed at the apex.

A Tesla coil is placed so that electrical emission occurs at the 2/3's power point of the pyramid. We do not know the voltage, though we think it is approximately 200,000 volts. During a phone conversation with Dean Hardy on May 21, 1996, he said they did the experiment later with much smaller tesia coils on the order of 50 KV and smaller pyramids and the results were the same.

Dean thinks that the pyramid is supported by acrylic columns. Acrylic columns would help to insulate the copper pyramid from the ground and further intensify the energy emissions. Also note that this photo was taken in a perfectly dark room with a time exposure of about 1 to 3 minutes, (our information regarding the technical details is very limited).

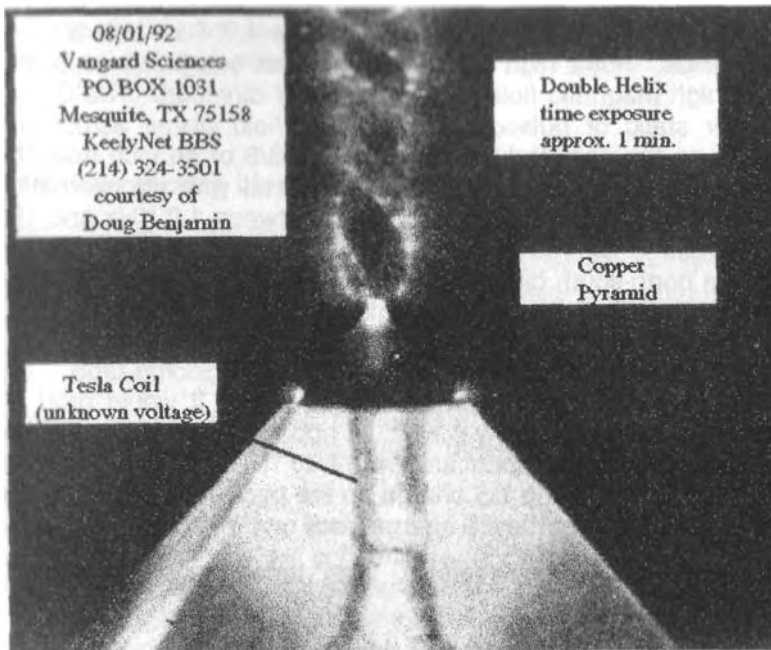

Figure 4.7.2-1 Spiral Energy off Pyramid

4.7.3 Electrostatic Energy at the Great Pyramid

When Sir W. Siemens, a British inventor, was visiting atop the great pyramid, it was noted by an Arab guide that there seemed to be a sharp ringing sound when Siemens raised his hand above his head and he experienced a tingling sensation in his fingers. Being of inventive nature, Siemens constructed a crude leyden jar from a wine bottle and a newspaper he had with him. He wet the newspaper with some wine and wrapped it around the bottle. The makeshift leyden jar became instantly charged with electricity by just holding it over his head.

During a trip to Egypt in the 1980s to conduct tests at the great pyramid, Joe Parr took measurements with an electrostatic voltmeter while he was on the top of the pyramid. Joe was able to show that the pyramid is a huge generator of electrostatic energy, generating many thousands of volts. When a meter probe was stuck out into the air flow coming off the side of the pyramid the voltmeter quickly pegged at its maximum reading. This would suggest that the electrostatic energy is due to a triboelectric effect whereby the air moving up the side of the pyramid collects ions due to wind friction on the pyramid sides.

4.7.4 Static Pyramid Electrostatic Power Generation

An experiment I performed is described in figure 4.7.4-1. Use a static array of pyramids. Put a high electric field across one pair of opposite faces and a high magnetic field across the other direction. The E-field can be either static or pulsed. The electric hold plates across the pyramid were on the east and west sides about 3/8 of an inch from the base of the pyramid. The plates were energized with an alternating current/voltage signal with a frequency range between 1.0 KHz and 160 KHz and a voltage of 165 volts. Magnets were placed across the pyramid in the north-south direction but they didn't make any difference so I eliminated them. An electrostatic volt meter was touching the south face of the pyramid with its detection probe. The pyramid was made of thin sheets of copper with the edges connected with Scotch tape. The ES voltmeter registered maximum around 15 KHz. It would drop off rapidly above 20 KHz and below 8 KHz. It appears that the pyramid or the ES meter has a resonance around 14 to 15 KHz. Turning the voltage off would shut off the ES charge on the pyramid and turning the voltage back on would turn the ES charge back on.

We are still at flea power levels!!! Stay tuned for more exciting discoveries.

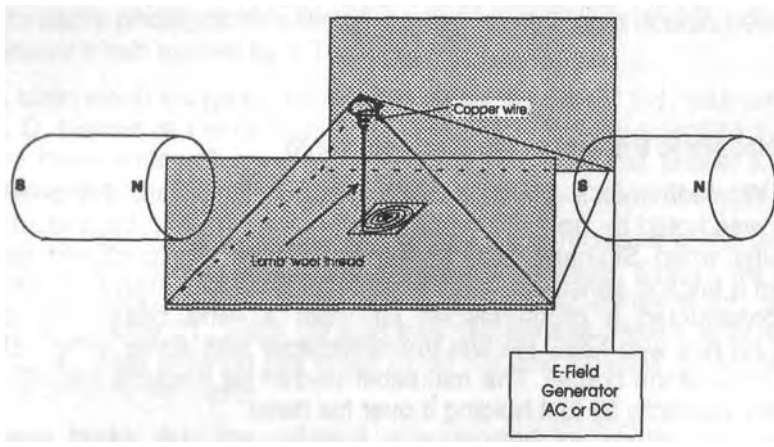

Figure 4.7.4-1 Static ES Generator Using Pyramid As Shape Power

4.8 Theory of How Pyramid Spiral Energy is Created

The intersecting lines and resultant planar force fields of the sides create the pyramid energy effects which result in aetheric energy concentration within the pyramid. The dessication effects seen with using pyramids to dry organic materials is a result of the energy effects associated with

aetheric energy. Natural aetheric energy flows across the earth in the north-south direction lead to the explanation of why magnetic orientation enhances pyramid energy effects, since the magnetic field is a flow of aetheric energy.

4.8.1 Intersecting Lines

From chapter 1, the experiment showing how shape power effects are created with intersecting lines, we can see how this can be applied very nicely to explaining why the pyramid creates a concentrated aetheric energy field. The four corners of the base and the apex are all formed by the intersecting lines of the triangular sides. These corners are where the aether flows concentrate from the triangular sides and form aetheric energy flows at these focal points. The magnetic effects created at the corners of the pyramid have also been confirmed in my laboratory testing.

Since all we need are intersecting lines to create aetheric energy gradients, which act to concentrate and focus aetheric energy into aetheric force, this clearly explains why a pyramid shape, made only of the outer edges and base to define the pyramid, functions as well as a solid pyramid. In fact, research by Joe Parr has shown that a solid pyramid must have some holes in it to maximize the energy effects. This also is another explanation of why there are "air shafts" in the great pyramid.

4.8.2 Concentrated Forces

The triangular faces, even with only the lines and not a solid face, form a three dimensional forcefield on each of the faces of the pyramid. The vortices at the corners are three dimensional and are pulling energy from all directions and concentrating it into the corners. Mathematical analysis of the forces on the inside of the pyramid show that the net geometrical resultant of the symmetrical draw of force from each corner to the interior of the pyramid is exactly at the geometric center of the pyramid. This center is located at 1/3rd of the pyramid height. Anyone with a knowledge of high school geometry can prove this simple fact.

4.8.3 Dessication Effects

Perhaps the first discovery which led to experiments with pyramids was finding dead animals in the Great Pyramid that had mummified naturally and not putrified. Extensive experiments by many pyramid researchers proved that the pyramid shape acts as a dessication shape

(i.e., the pyramid dries out material put into the pyramid) and it seems to work best at the 1/3rd height.

Another fact about aetheric energy is that concentrated aetheric force is hygroscopic. This means that concentrated aetheric energy will collect moisture. Clouds are perfect examples of this in that it was proven that it is possible to dissipate clouds by drawing out the aetheric energies from the clouds. The converse is also possible, that is, to create clouds by concentrating aetheric force. Reich developed a machine, discussed in chapter 5, called the cloud buster which draws orgone (i.e., aether) from clouds and they dissipate.

On the surface, this looks like the pyramid should make things get wetter rather than dry them out, since the pyramid concentrates the aether. However, the corners of a pyramid actually draw the aether from the center of the pyramid and focus it off the corners. Thus we see that anything with water or water vapor inside the pyramid would have its moisture drawn off, and this easily explains the dessication effects associated with the pyramid shape.

4.8.4 Magnetic Orientation

The next thing we have to explain is why pyramid energy is enhanced when the pyramid is oriented facing north-south and east-west with respect to the compass. Experimentation has shown that the maximum pyramid energy effect is obtained when the pyramid is thus oriented. Even though the Great Pyramid is not currently oriented exactly with the earth's magnetic field but more with the north pole (i.e., true north as opposed to magnetic north which is usually different), the speculation is that at one time the Great Pyramid was geomagnetically oriented, but the earth's magnetic field has changed or the earth has shifted on its axis to cause a magnetic field alignment difference.

In a compass north/south orientation there would be an aether flow across the pyramid in three directions. The magnetic field is a vortical aether flow from south to north. The earth is rotating on its axis so there is a slight aether drift (flow) from west to east. When these two flows meet at the pyramid, it would cause the aether to flow around the pyramid in a CCW direction (looking down on the pyramid) with an upward thrust due to the sloping pyramid. The third flow is a flow/pressure of the aether from above down into the earth. When this flow hits the CCW rotating flow, a vortex action is created which could create toroidal vortexes in the aether. These would automatically become simple particles and most likely they would be electrons. Figure 4.8.4-1 shows the etheric flows acting across a magnetically oriented pyramid. The current theory in the new vision science network is that the sub-atomic particles are various combinations of aetheric toroidal vortexes as first discovered and written about by John Keely in

the late 1890s. Also, see Paul Stowe's math in chapter 8 for the proof of this assertion.

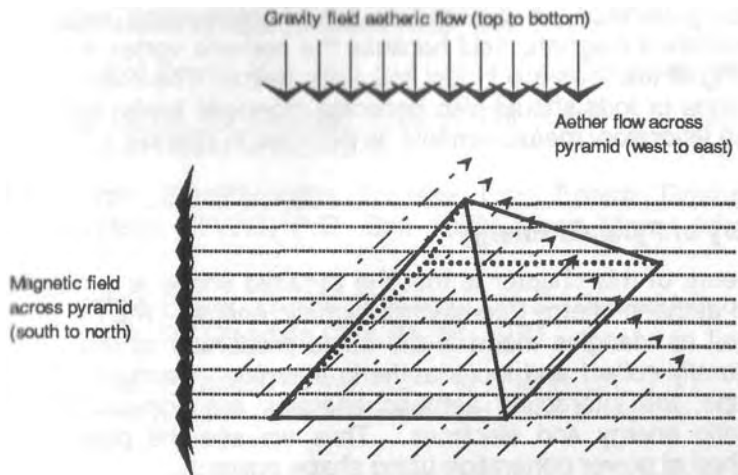

Figure 4.8.4-1 Aetheric Flows Acting Across a Magnetically Oriented Pyramid

So we now have a method of explaining how the electrons are formed and why the pyramid would act as a charge generator.

4.8.5 Magnetic Generation

Perhaps one of the more mysterious enigmas associated with pyramid shapes is the ability of the pyramid to generate a magnetic field. In Bill Kerrell and Kathy Groggin's book, The Guide to Pyramid Energy³, they discuss some very unique experiments with pyramid shapes. They had some engineers with very sensitive gauss meters measure magnetic fields in and around pyramids. Their basic discovery was that the pyramid actually generates a mild magnetic field which increases as the pyramid is oriented to the earth's magnetic field. This magnetic generation effect was also independent of the material that the pyramid was made from. The effect could be explained away with metal pyramids; however, with dielectric materials this effect does not fit with any explanations of standard physics.

As described in chapter 1, a simple experiment to test the hypothesis that intersecting rods would generate a magnetic and electrostatic field was proven. These results are depicted in figure 1.4.5-1.

This effect of the pyramid being an actual generator of a magnetic field is very explainable with my discovery that the intersecting lines generate a flowing vortex of aetheric energy. The magnetic field of a permanent

magnet is also a flowing vortex of aetheric energy as discussed in chapter 1 of this book.

Q.E.D - Ergo - Eureka! A pyramid Of set of intersecting rods will therefore generate a magnetic field because the aetheric vortex flows at the intersecting of the lines are in fact magnetic fields. This means that intersecting lines or rods should also generate magnetic fields, and this was proven in laboratory measurements as depicted in chapter 1.

4.9 Summary of Pyramid Energy

The main theme of this chapter is that the pyramid shape is a natural transducer of aetheric energy into electromagnetic energy. The pyramid shape, as well as triangles made in the same proportion as the great pyramid, naturally collect and focus aetheric energies. Because of the pyramid shape; the interacting aetheric energies are converted into electromagnetic energy and electrons. Thus we see the path to a possible method of power generation using shape power.

4.10 Bibliography

1. The Great Pyramid. Its Divine Message. D. Davidson and H. Aldersmith, London, William Rider and Son Ltd., 1924.
2. Pyramid Power. Max Toth and Greg Nielson, Freeway Press, 1974.
3. The Guide To Pyramid Energy. Bill Kerrel and Kathy Gorggin, Pyramid Power V, Inc, 1975.
4. Energy: Breakthroughs To New Free Energy Devices. Dan A. Davidson, RIVAS, P.O. Box 1090, Sierra Vista, Arizona 85636, 1977.
5. Pyramid Power. G. Pat Flannigan, Ph.D, Pyramid Publishers, 438 Cypress St., Glendale Calif. 91204,1973.
6. Beyond Pyramid Power. G. Pat Flannigan, Ph.D, DeVorss & Company, 1641 Lincoln Boulevard, Santa Monica, Calif. 90404, 1975.
7. Secrets of the Great Pyamid. Peter Thompkins, Harper & Row, Publishers, New York, 1971.
8. Great Pyramid Proof Of God. George R. Riffert, Destiny Publishers, Merrimac, Mass., 1932.
9. The Secret Power of Pyramids. Bill Schul and Ed Pettit, Fawcett Gold Medal Book, 1975.
10. The Psychic Power of Pyramids. Bill Schul and Ed Pettit, Fawcett Gold Medal Book, 1976.
11. Pyramid Energy and How It Works. James Wyckoff, Zebra Books, Kensington Publishing Corp., 1976.

CHAPTER 5

SHAPE POWER AND "SACRED GEOMETRY"

This chapter examines a concept which has become popular in modern metaphysical circles, sacred geometry, which is the implication that there exists geometrical patterns that are related to the foundation of life and existence, of creation, of God. The relevance of sacred geometry to Shape Power will be examined.

5.1 Sacred Geometry

The concept of Shape Power as natural generators, foci of higher order energies, and transducers of that energy into more recognizable energies such as electricity and magnetism is stating essentially the same thing as the above definition of "sacred geometry".

Whether you ascribe some mystical significance to geometrical patterns on the basis of faith, intuition, symbolic magic, or observed results or you prove in the laboratory with experiments and rigorous "scientific" procedure, you have changed nothing except semantics as far as the end result. Both are tapping energy using natural geometrical principles that exist in the natural order of the universe. These principles reveal to us the sacred foundation of all things created.

As a mathematician and physicist, I shy away from describing geometrical figures as "sacred". As one deeply involved in metaphysics, I understand where those who embrace the term "sacred geometry" are coming from. However, as one gets more deeply involved in understanding how the universe functions, and in particular, how geometrical shapes resonate and generate power, the enigmatic view that geometrical symbols are sources of power unknowable or incomprehensible is a childish view. A true mystic believes that he/she

can know the cause and effect of things since each person is a part of the Whole, a spark of the Holy Spirit of God, and by meditation and contemplation can achieve a true understanding of the universe and its function and operation.

Those who are using the term "sacred geometry" apply it to both the geometrical figures most would ascribe to normal geometry and to certain mathematical concepts which would be better described as "sacred mathematics". These are described in the following sections and related to the physics of Shape Power as discovered in my research and experiments.

5.2 Geometrical Figures Of Sacred Geometry

5.2.1 A Point

As a geometrical concept, the point exists as a definition and basic concept. As a physical reality, the point does not exist, since it is a mental construct and, by definition, has neither length, breadth, nor width, ergo it does not exist as a physical entity.

Nevertheless, the point is used to define the center of the circle, the center of the sphere, the end points of a line, the focus off at infinity. So we can see that a point, though having no dimension, is the basis of all dimension.

From chapters 1 and 2, we find that the simplest physical construct to act as a "point", from the macro level, would be a single atomic particle which acts as both a central receiver and radiator of aether force. From a micro level (i.e., at the atomic level), even the simplest atomic particle has form and structure. Figure 5.2.1-1 depicts the vortex flows of a complex atom.

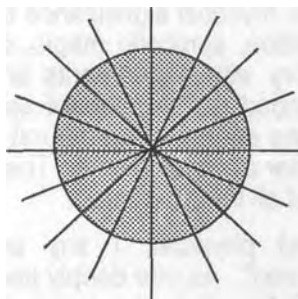

A complex atom with many orders of aetheric stress vortex flows (lines).
A simple atom like hydrogen would have

Figure 5.2.1-1. Cross Section of Vortex Stress Flows of Complex Atom

5.2.2 A Circle

The circle, the two-dimensional locus equidistant from a point, is used symbolically throughout history as a symbol of the unity of all things, the basic icon of deity. As a Shape Power symbol, the circle acts to focus the primordial energy of the universe at the circle's center.

Testing with clairvoyants showed that the maximal power of the circle could be obtained by drawing the circle starting at the bottom of the circle. Thus we see that there is more to the physics of Shape Power than the simple geometrical pattern. Intent (i.e., the mental factor) and the manufacturing processes of creating the symbol also govern the amount of power associated with the symbol. Figure 5.2.2-1 depicts the shape power pattern of a circle.

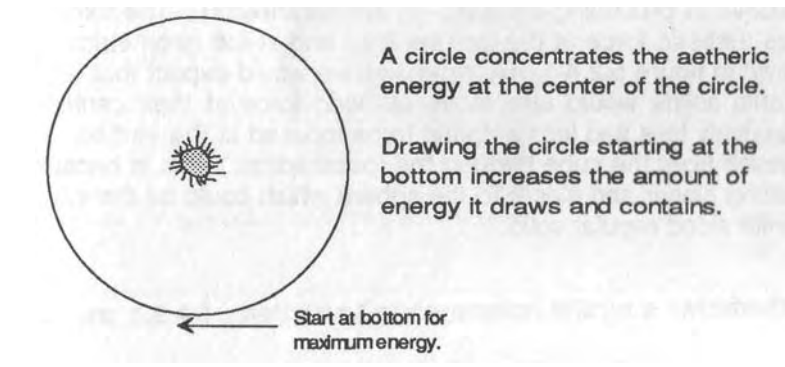

Figure 5.2.2-1. Shape Power of a Circle

5.2.3 A Sphere

Some believe that the sphere is the most perfect of forms. It is the quintessential symbol of unity. From a Shape Power perspective, the sphere is simply a three dimensional version of the circle, whereby the atoms of the sphere act as radiators of aetheric force, and all the points of the sphere focus to the center of the sphere creating an intense focus of aetheric force at the center.

5.2.4 PLATONIC SOLIDS

The basis for the organization of physical matter in the mineral realm are the 5 Platonic solids. These are related to the 5 levels of energy as envisioned by the ancient Greeks. These are:

1. Tetrahedron - relates to fire

2. Cube or (Hexahedron) - relates to earth
3. Octahedron - relates to air
4. Dodecahedron - relates to spirit or aetheric
5. Icosahedron - relates to water

These three dimensional figures are the basis of crystals and minerals. These are the only five regular polyhedra, as can be proven in geometry, and are made from equilateral and equiangular polygons. The geometric concept of duals relates the polyhedra, whereby the dual of one is created by connecting the midpoints of the faces of the other. The tetrahedron, the most simple of 3-dimensional polyhedra is a dual to itself. The cube and octahedron are duals of each other as are the icosahedron and dodecahedron.

The only platonic solid we have thus far examined, from a shape power perspective in preceding chapters, is the tetrahedron. The tetrahedron focuses aetheric force at the four vertices and at the geometrical center as shown in figure 5.2.4-1. By extension we would expect that the other 4 platonic solids would also focus aetheric force at their centers with progressively less and less aetheric force focused at the vertices as one progresses from the cube through the icosahedron. This is because we are getting closer and closer to the sphere which could be thought of as an infinite sided regular solid.

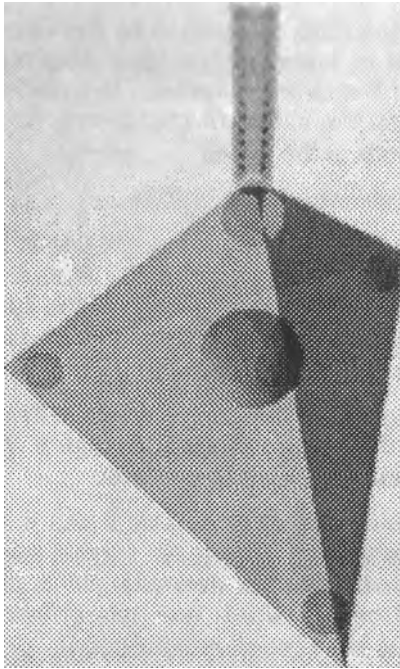

Figure 5.2.4-1. Aetheric Concentration Within a Tetrahedron

5.3 The Mathematics of Sacred Geometry

5.3.1 Pi

Pi (π), the ratio of a circle's circumference to its diameter, is a transcendental or irrational number. This means that it is a number which cannot be defined as the ratio of two whole numbers and the resultant division is a non-terminating number.

Pi is approximately equal to 3.14159...

Pi is built into the geometry of the Great Pyramid in Egypt with amazing accuracy and proves the builders were technologically advanced enough to signal later civilizations that advanced technologists were on the earth long ago.

5.3.2 The Golden Mean (Phi)

The golden mean or golden ratio, referred to by the Greek letter Phi is another transcendental or irrational number. This number was also built into the geometry of the Great Pyramid. The golden mean occurs naturally in nature such as the shape of chambered nautilus shell, and the spiral of sunflower seeds in the flower.

Phi is approximately equal to 1.618034...

The golden mean is defined by splitting a straight line in such a way that the ratio of the line to the larger portion of the line, equals the larger portion of the line divided by the smaller portion of the line. Some of the aspects of Phi were mentioned in the chapter on pyramid energy so we will not repeat them here.

One of the interesting aspects of the golden mean is the fact that it was utilized by many artists in their paintings, because it was believed to provide a sense of aesthetically pleasing proportion.

Related to phi is the phenomena of phylotaxis which is the tendency in nature to grow in spiral patterns.¹ There are special spiral patterns that are related to phi mathematically. For example, plants and trees tend to have branches and leaf growth which are natural spirals. The well-known chambered nautilus shell grows in a phi spiral.

My first book² relates some research done on understanding how the human ear hears and the mechanisms involved. The inner ear has a spiral shaped chamber, the cochlea. The cochlea is lined with tiny hairs. Research by Fletcher³ at Bell Laboratory showed that the chamber acted as a resonance tube and equal distances along the spiral were harmonically related (see figure 5.3.2-1). If we relate this to the phenomena of phylotaxis it may well be that the tree or plant is a resonant structure with specific frequencies as part of its energy patterns. These frequencies and their harmonics would resonate along the length of the plant and its limbs in a natural phi spiral.

5.3.3 Perfect Right Triangles

Perfect right triangles are right triangles with sides of whole numbers such as 3/4/5, 5/12/13 and 7/24/25. Again we find that the Great Pyramid contains one of these perfect right triangles, the 3/4/5 triangle, contained within the "King's Chamber" of the pyramid.

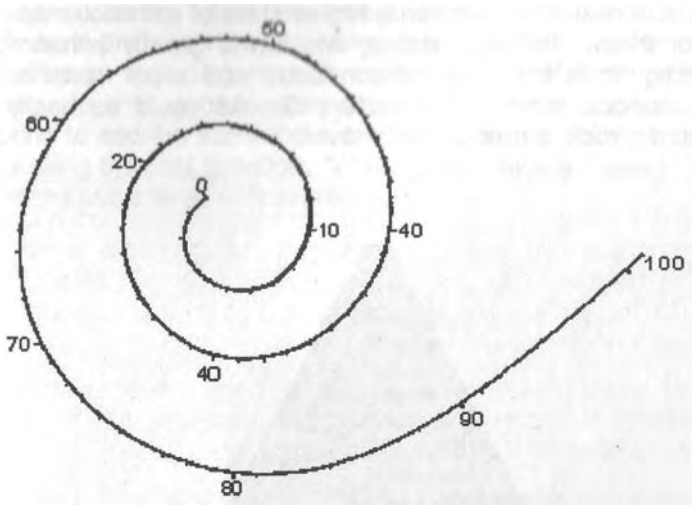

Figure 5.3.2-1. Inner Ear Vortex Resonances

5.4 Shape Power and Sacred Geometry

A prominent Shape Power geometric shape, the pyramid, was constructed with various "sacred geometry" and "sacred math" fundamentals. One could ask then, "are these various mathematical patterns and numbers built into the pyramid because they are related to the Shape Power energy production or are they there as a testimony that advanced technological civilizations have been on the earth before the dawn of history or do they serve other functions?"

Experimentation on the energetic aspects of pyramid power shows that exact proportions of the Great Pyramid were not an important factor in its generation of power.⁴ We have, in fact, proved that the generation of pyramid power is a function of the edges converging as angles, creating an aetheric vortex which translates aetheric force into magnetic and electrical forces as shown in figure 5.4-1. This effect operates with a range of angles. More research is needed to determine if there are optimum angles. There is a large amount of research required to define all the parameters of power generation with converging lines.

5.5 Shape Power, Sacred Geometry, and Consciousness

The students in the ancient Greek Mystery Schools would meditate on the various platonic solids. They believed that meditation on these geometric figures would elevate their consciousness. The Yogis believe

that true contemplation of anything will reveal the physics of the object as well as its esoteric aspects. Correct concentration and stilling of the outer consciousness puts one into a higher state of consciousness, such as alpha or theta. In these states, intuition is greatly enhanced and understanding flows from the subconscious and super consciousness into the conscious mind. The ancient Greeks could as easily have contemplated a rock, a tree, or their navel.

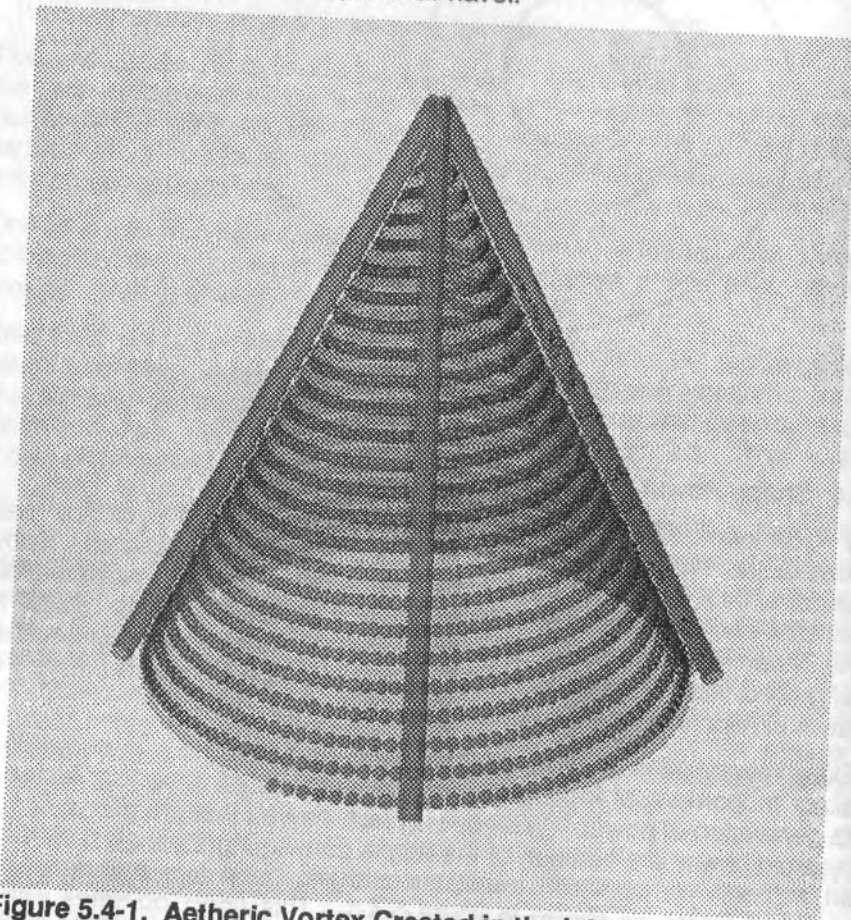

Figure 5.4-1. Aetheric Vortex Created in the Intersecting Lines of Pyramid Corner

5.6 Summary of Shape Power, Sacred Geometry

What is regarded currently as sacred geometry is, in reality, the operation of physical and energy related natural laws, many of which we do not understand at this time. Historically, what man does not understand, he ascribes to the spiritual, to the gods, to magic, or whatever. From a metaphysical point of view, the various energetic

aspects of the sacred geometries will become known as we get deeper into an understanding of nature and the universe. What is now sacred geometry will, in the future, become known laws of physics. This may seem to be a profane view, however, the metaphysician knows that the entire universe including man is an expression of the Creator of the universe. In that sense, every aspect of existence is sacred. So attempting to ascribe sacredness to geometric principles is a step back in addressing the real question, "What is the physics behind the various phenomena associated with sacred geometry?".

5.7 Bibliography

1. Introduction to Geometry. H. 8. M. Coxeter, John Wiley & Sons, Inc., Publishers, 1961.
2. Energy: Breakthroughs To New Free Energy Devices. Dan A. Davidson, RIVAS, P.O. Box 1090, Sierra Vista, Arizona 85636, 1977.
3. Mechanics, Heat, and Sound. Francis Weston Sears, Phd., Addison-Wesley Publishing Company, Reading Mass., 1958.
4. The Guide To Pyramid Energy. Bill Kerrel and Kathy Groggin, Pyramid Power V, Inc., 1975.

SHAPE POWER FROM CRYSTALS

This chapter examines shape power as applied to crystals and crystalline structures.

6.1 Introduction

In previous chapters, the basic theory is established that converging lines of matter create a vortex in space which has both magnetic and electrostatic properties. These principles were extended and shown to apply to the basic processes of how pyramid energy is created by the pyramid shape and the physics behind sacred geometry. In this chapter, I show how the same physics applies to the science of crystals, both from a physics crystallographic viewpoint and its metaphysical correlate of using crystals as foci of higher energies for adjuncts in healing, meditation, and other metaphysical practices.

Crystals have been used as gemstones, amulets, and foci of power and energy from the earliest of times. The intrinsic beauty associated with natural crystals makes them desirable objects. Sensitives (i.e., those who can feel and/or see the subtle energy emanations from crystals) know that crystals do act as transducers of aetheric forces. The same converging lines present in the pyramid, which is intrinsic to crystalline shapes, are present in crystals from the macro level on down to the atomic realm. The atomic lattice structure of crystals makes them natural transducers of aetheric force and their exterior shape also lends itself to shape power physics.

6.2 Crystalline Structure and Shape Power

In chapter 1, I developed the concept that converging lines of atoms, such as rods of wood, create perturbations in the aether. Further, that enclosed geometrical line structures, such as a tetrahedron or pyramid, act as concentrators of aetheric force. The net result of this is the creation of magnetic and electrostatic fields, as well as concentrations of aetheric energy.

Crystal lattices are ideal for aetheric energy concentration, since they are repeating motifs of geometrical line structures. The only difference being that, in previous chapters, I discussed this in terms of macro structures, and, in this chapter, we are examining structures at the atomic level where the atoms form the basic crystalline shape power structure. Almost any type of lattice will act as a container of aetheric energies whether it is a structure made of individual atoms forming the lattice at the atomic level or rods of material at the macro level.

I will also extend the single macro crystal ideas into macro lattices as high-powered shape power containers.

6.3 Atomic Crystallography

Crystals come in an infinitude of shapes, sizes, structures, and composition. Crystallography is the study of crystals and the properties associated with crystals. There are a number of scientific tools used to measure the properties of crystals.

X-ray crystallography uses high energy particles from an x-ray tube focused onto a crystal to determine its atomic structure. The x-rays reveal that crystals are regular structures from their macro level on down to the atomic level. At the atomic level, the atoms chain together into repetitive patterns based on the 5 platonic solids¹.

Modern, atomic force microscopes, used in crystallographic analysis, provide information on the structure of the atoms at the atomic level. These new microscopes provide atomic level, highly accurate, pictures of the surface structure of materials.

6.3.1 Platonic Solids

In two dimensional space (i.e., a plane) the regular (i.e., where the faces are all equal) geometrical figures are triangles, squares, pentagons, etc. As far as three dimensional space is concerned, there are a limited number of three dimensional figures.^{1,2} If we try to fit these together to make three-dimensional figures, then we come up with the tetrahedron (4 triangles), cube (4 squares), octahedron (8 triangles to make a double-sided pyramid), dodecahedron (6 pentagons), and the

icosahedron (20 triangles). These are the 5 platonic solids. All crystalline structures are variations and combinations of these 5 geometrical figures and there are no other regular solids.

6.3.2 Crystalline Structures

Crystals are characterized atomically as having "long range order".³ This means, quite simply, that the atoms and molecules which comprise a crystal are arranged in definite patterns and they are not jumbled and disorderly. In the solid structure of a crystal, every atom has neighboring atoms at specific distances. Such an ordering of atomic structure is said to be "crystalline". Crystal morphology is the study of crystalline forms and the outward external shape of the crystal is called its "habit". Crystals have a definite structure which means that they have specific atoms arranged in specific orderly fashion.

Crystals have definite repetitive patterns called "motifs", and when these motifs are repeated regularly throughout the crystal we call this a "lattice" structure.

6.3.3 Lattices as Shape Power Energy Containers

So what does this mean for crystals as shape power generators. Well, I have just stated it, "... lattice will act as a container of aetheric energies..". From my analysis of pyramid energy, I showed that the pyramid acts as a container/concentrator of aetheric energy and like any container, it can hold only so much aetheric energy before it starts squirting out or distorting the container. In the case of a pyramid, it squirts out at the apex and at the four base corners.

By analogy, a crystal lattice will collect and contain a certain amount of aetheric energy and at some point it will come squirting out. Since the crystal lattice is very structured, the squirt will be directionalized and the crystal will act as a channel for the aetheric energy. Its most likely exit paths are at the external points of the crystal.

6.3.4 Crystals as Aetheric Energy Healing tools

In analyzing the psychic healers and various types of new age crystal users⁴, one finds that they use the pointed end of the crystal because they have found that is where the healing energy comes off. The crystal acts as a collector and concentrator of aetheric energy and channels the overflow off the points of the crystals. A concentration of aetheric energy, when directed at a patient, will tend to increase the patient's energy level. The increased energy assists the body in repairing itself, thus enhancing the healing process. This same process can be used on

the macro level by putting a patient inside a pyramid to increase their energy level.

6.4 Macro Crystallography

The most basic of three dimensional solids, the tetrahedron and the pyramid, are repeated in figure 6.4-1 from chapter 1, and show the energy coming off the top point. The focusing and trapping of aetheric force is accomplished by the aetheric force fields created by the intersection of edges of the tetrahedron. Similarly, the square base pyramid acts in a similar manner to trap the energies within the structure. In these two structures the energy is concentrated at the geometrical center, the 1/3rd height level as well as at the vertices where the edges intersect.

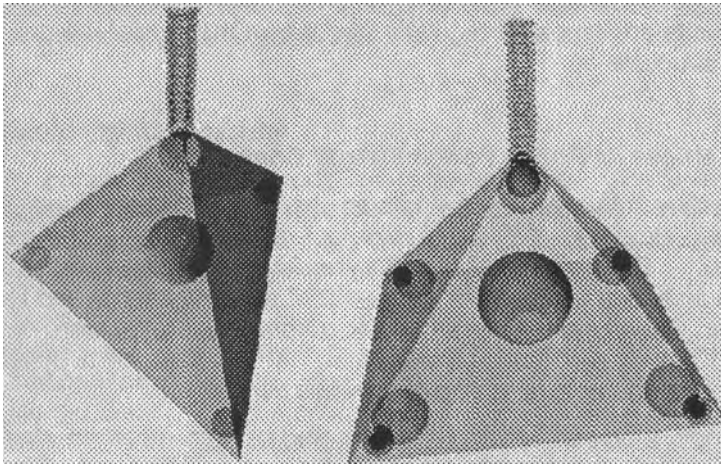

Figure 6.4-1 tetrahedron and Pyramid Energy Collection

6.4.1 Macro Lattice Structures

So what would happen if we make a lattice using the pyramid as a motif? This was done and some very interesting effects were discovered. Eight pyramids were arranged in two rows side-by-side (see figure 6.4.1-1). The energy patterns from this lattice are the standard energies coming off the top of each pyramid, however, it is greater than from a single pyramid. There appears to be an intensification of energy off the peaks of the pyramids when they are in the lattice. Also, the energy that normally flows up the sides of the pyramids seems to be focused more in the channels between the pyramids.

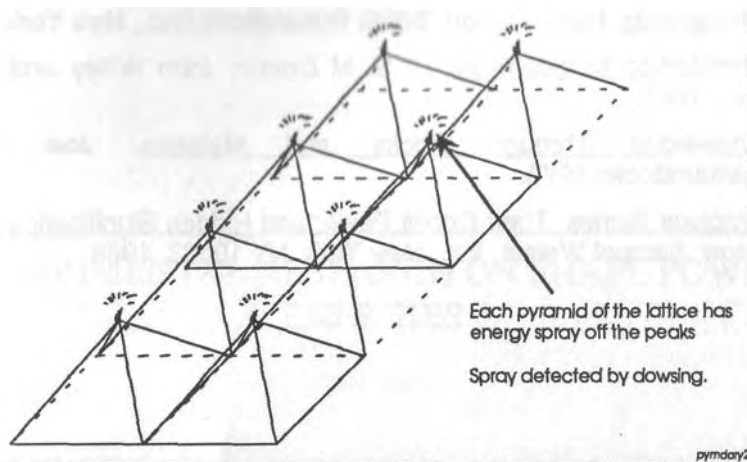

Figure 6.4-1 Pyramid Array Creates Novel Energy Pattern

Pyramid research got a major impetus when Carl Drbal received his pyramid razor blade sharpening patent based on the theory that the pyramid acts as a microwave resonator. By having pyramids in an array, perhaps they begin to act as microwave waveguides or a macro level resonator to draw in more aetheric force. They certainly have a larger cross section to trap energy.

6.5 Summary of Crystals as Shape Power Collectors

Aetheric energy effects from single crystals has been examined and shown to correspond to the expected effects from singular geometrical structures, multiplied by the number of motifs repeated throughout the crystal. The combining of crystals into a lattice structure shows that the crystal lattice acts as a container of aetheric force. As such, the energy of the crystal can be used for healing and other practices.

This is another area in which we have to do a great deal more research. Probably the most productive research will be in the area of macro lattice structures. We certainly have only mined the barest of information on this fascinating topic.

6.6 Bibliography

1. Mathematical Crystallography and the Theory of Groups of Movements. Harold Hilton. Dover Publications, Inc , New York, 1963
2. Introduction to Geometry. H. S. M Coxter, John Willey and Sons, Inc., 1961.
3. Knowledge Through Rocks and Minerals. Joel Arem, BantamBooks,1973.
4. Precious Stones. Their Occult Power and Hidden Significance. W.B. Crow, Samuel Weiser, Inc., New York, NY 10003,1968.

CHAPTER 7

EXPERIMENTAL RESEARCH ON SHAPE POWER ENERGIES

This chapter discusses some fascinating experiments which relate to research on shape power.

7.1 Gravity Energy Detectors

It is obvious that the larger the mass the more aether which flows into the atomic structure of the mass to sustain the atomic structure. Mass is both radiating and absorbing aetheric energy. Other mass in the vicinity will cause perturbations in this aetheric flow. Because of this fact, aetheric flow detectors can be constructed by taking advantage of this principle. My first working gravity or local aetheric stress/flow detector was demonstrated at the 1990 Extraordinary Science Conference in Colorado Springs, Colorado^{1,2}.

7.1.1 Detection of Gravity Stress Using Dielectrics

The basic principle of the gravity detector is the fact that the electronic charge structure of a given mass is a function of the amount of aether flowing into the mass. The charge around the atom is governed by the amount of aether flowing into and out of the mass. My reasoning was that dielectrics would make the best aetheric flow detector. In dielectrics, the electronic charge is isolated and trapped within the dielectric material since the charge cannot flow and dissipate. Early success had been accomplished by Townsend Brown⁴ (circa 1959) and Jerry Gallimore³ (circa 1975) in using dielectric materials to detect local gravity effect.

By using a high dielectric, such as titanate zirconate or barium titanate, the amount of charge change is directly readable by putting electrodes on each pole of a polarized dielectric. My first detector circuit ¹ used a pico amplifier attached to electrodes to amplify the signal. Then the voltage/current changes across the dielectric are easily measured directly by a voltmeter. Figure 7.1.1-1 depicts the output of the gravity detector circuit as a graph of local gravitational stress (i.e., aetheric stress). The graph readily shows the daily swing of aetheric flow on the dielectric material as the sun and moon affects the earth's gravity field and gravity flows into the earth. The data was taken during a solar eclipse and shows the effect of local aetheric field stress dropping during the period of the eclipse. The solar eclipse started about 11:35 a.m. and ended about 12:45 p.m.

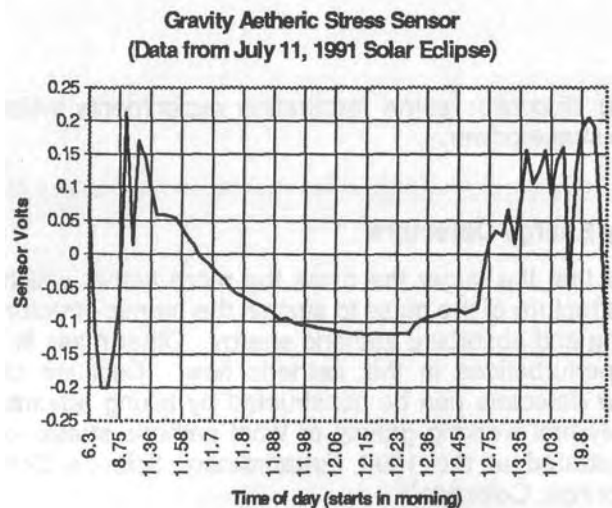

Figure 7.1.1-1 Piezoelectric Gravity Wave Sensor During Solar Eclipse (time is in decimal fractions of an hour)

The circuit for the gravity wave detector is shown in figure 7.1.1-2 with instructions to build the circuit shown below. A detailed schematic is shown in figure 7.1.1-3.

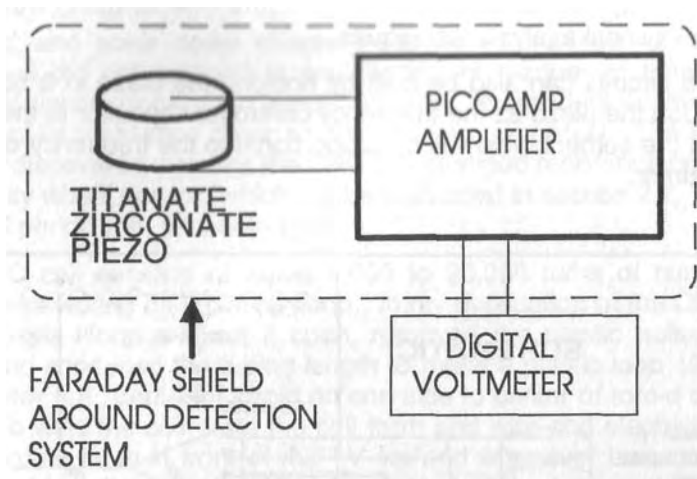

Figure 7.1.1-2 Block Diagram of Davidson Gravity Wave Detector

1. Solder fine (#28 or smaller) wires to the poles of the piezo ceramic for connection to the op amp or mount the piezo in a machined Teflon case with copper electrodes pressing against the conductive poles of the piezo. Use conductive paste to assure connection.
2. Shock mount the piezo to isolate it from sonic and physical vibration.
3. The op amp (AD 515) should be isolated from stray electrostatic fields. Also, good electrical wiring procedures should be followed to assure success. Addition of other components to the circuit will obviate the sensor. For example, addition of any capacitors will act as noise sources that will kill the piezo effects.
4. The power supply can be a 9-volt transistor battery.
5. The entire sensor can be isolated from EM fields by installing the circuitry and sensor in a Faraday type shield. Additional shielding can be done with mu metal (magnetic) shielding.
6. Isolate from light by installing the sensor in a light tight case. It may be possible to combine Faraday shield with the light shield.
7. A standard digital voltmeter can be used for reading the output across pin 6 and ground.
8. Calibrate the sensor for temperature by measuring sensor temperature over a several day period along with the sensor

output, and back out the temperature effects using well-known statistical analysis techniques.

Improved circuits can also be built by hooking the piezo in a 555 timer circuit. Use the piezo as the frequency controller capacitor in the circuit. Stress in the aetheric field will be proportional to the frequency output of the 555 timer.

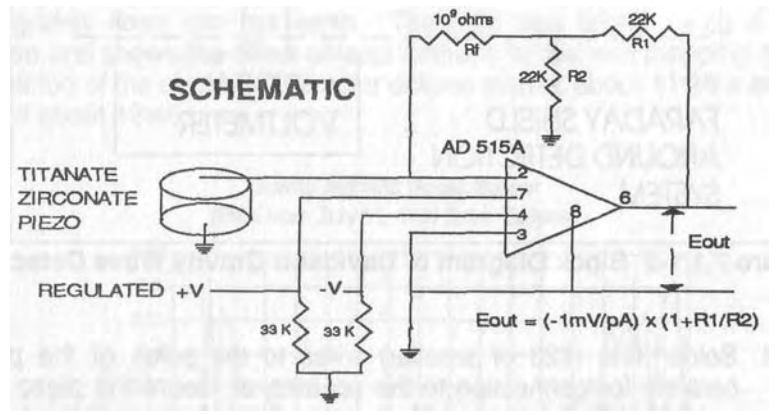

Figure 7.1.1-3 Schematic of Davidson Gravity Wave Detector

Greg Hodowanec did some experiments⁵ in 1986 and claimed success in detecting aetheric energies. His ideas gave no reference to either Gallimore or T. Brown and perhaps he was unaware of them. Hodowanec used an ordinary capacitor as a detector and an operational amplifier to boost the change in capacitance occurring in the capacitor. At this time there is controversy as to whether Hodowanec's data correlates with any known phenomena. Hodowanec's detector should at least have tracked daily aetheric changes due to the effects produced by the sun and moon, but none of his data showed this. My experiments with his detector showed it is highly susceptible to temperature changes and it is quite possible the data he published were temperature effects.

7.1.2 The Do Nothing Coil

In discussing my results of gravitational energies (i.e., aether stress flows) with a fellow gravity researcher, Joe Parr, he mentioned he had similar results with dielectrics (i.e., they worked but are temperature and light sensitive) and had discovered a better detector for certain conditions. Joe accidentally discovered the "do nothing coil", which proved to be an aetheric stress detector. It was a strange coil to which he attached the moniker "Do Nothing Coil" (DNC). The DNC would

detect the aetheric gravity flow without the bothersome temperature, photonic, and sonic noise effects. Joe called the coil "do nothing" because it did not respond in any significant manner to magnetic or electrical signals from DC to about 300 Ghz. By accident he discovered that the coil's resistance changed during a 24 hour period. The amazing thing he discovered was that the DNC coil changed resistance only when the gravity wheel sensor, which will be discussed in section 7.2, was in a very null period with little activity.

The DNC coil consists of about 4,000 to 20,000 turns of number 34 copper wire wound on a plastic hoop. In my duplication of the DNC coil, I got a Hula Hoop and cut it open, removed the plastic noise maker beads and shortened the tubing length to make a plastic loop 19 inches in diameter (i.e., center of toroid on one side to center of toroid on other side). To wind the coil, I set the coil form and wire and electrician tape on the coffee table in front of the TV set and whenever I was watching TV, I would wind a couple of hundred turns on the loop and cover the turns of wire with black electrician tape to keep the coil in place. After a couple of months, I finally had wound the DNC coil. It ended up being a little over 8,000 turns. I put a BNC connector on the ends of the coil for a completed DNC.

Figure 7.1.2-1 shows the results of a few days of data taken with the DNC coil. The graph clearly shows the daily resistance changes. The change in resistance is a direct readout of the local aetheric stress flow changes. Resistance changes in the coil because the atomic lattice's electronic charge in the metal in the wire changes as more or less aether is flowing in the nuclei of the coils atoms, thus changing the wire's conductivity because there are more or less electrons created in the wire by the changing aetheric stress. During the course of a 24-hour period, the sun, moon, planets, as well as the stars, put differing stress levels on the earth's aetheric field, which directly affects the flow rate of aether into the nucleus.

7.1.3 The Physics of Aetheric Stress (i.e., Gravity Flow) Detectors

The physics behind the use of materials such as dielectrics and metals as sensors for detecting the stress changes in the local aetheric field are based on the Keely vortex model of the atom. The nucleus of the atom is made of atomic particles that are torroidal, donut-shaped particles in the aether. The torroidal vortex is a stable shape in the aether. Each of the sub-atomic particles is in a constant exchange with the local aetheric field.

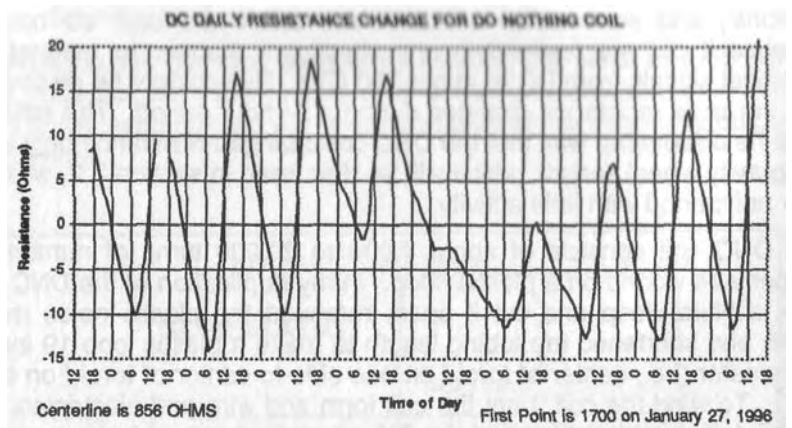

Figure 7.1.2-1 The DNC as a Gravity Sensor Example

7.2 Joe Parr's Pyramid Energy Bubble Discovery

The following material on Joe Parr was given during *my* talk at the International Tesla Society in 1992. The text and graphs are from that speech. Part of the information on gravity wheel experiments was given at the 1996 Natural Philosophy Alliance sub-group, during the American Association for the Advancement of Science (AAAS) conference in Flagstaff, Arizona, at the Northern Arizona University campus.

7.2.1 Shape as an Energy Sensor

A major breakthrough has been achieved by Joe Parr, whereby he has developed several sensors that quantify pyramid energy. His gamma ray transducer is based on his discovery that pyramid energy attenuates gamma rays. He has discovered that one of the aspects of aetheric energy in and around a pyramid is as a spherical aetheric energy field centered at the 1/3 height level. This is shown in Figure 7.2.1-1 which depicts one of Joe's first experimental setups to detect pyramid energy fields. This discovery has led to the possibility of a free energy machine, as well as a true space drive based on generation of gravitational force fields using rotating pyramid shapes.

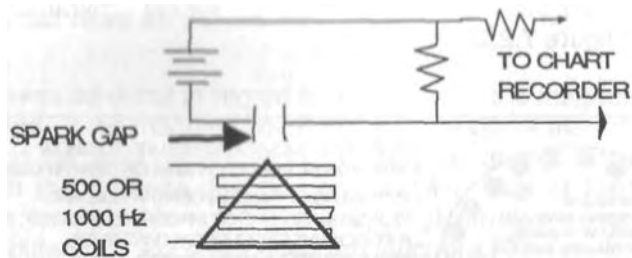

Figure 7.2.1-1 Early Joe Parr Data Collection Setup

One of the things which Joe found in the pyramid energy conversion experiments, as depicted in figure 7.2.1-1, was that the pyramids quit responding now and then and he had no explanation as to why. He did find correlation with celestial events and his experiments. Sun spot activity seems to affect the intensity of the pyramid energy bubble.

The gravity energy sensor, which Joe Parr discovered, involves the Great Pyramid and pyramid shapes in general. This sensor uses a static (i.e., non-moving) pyramid aligned north-south/east-west. Flat coils wound on audio tape reels were placed on the north and south side of the pyramid. A spark gap, made from a blown 1 microfarad capacitor, was placed at the apex of the pyramid in series with a battery, resistor and chart recorder. A chart recorder registered daily changes in the energies around the pyramid.

The chart recorder records the state of a bubble of energy which surrounds the pyramid. The energy bubble, over time, had various levels of opacity to all types of radiation. Experiments putting radio frequency emitters, radioactive source—specifically beta and gamma emitters, magnetic sources, and ion sources all showed attenuation when in the energy bubble which surrounds the pyramid. Intensive research over 13 years showed that the bubble could be fed negative ions and this would intensify the opacity of the bubble. At certain times of the year, the energy bubble would totally block the force of gravity, nuclear radiation, and electromagnetic radiation. Another effect revealed that the pyramid seemed to be resonant at 500 and 1000 Hz. This means that the energy bubble or forcefield around the pyramid becomes totally opaque (i.e., non-conductive) to all known forces.

7.2.2 Dynamic Pyramid ES Generation

At one time during the 11 year sun spot cycle, the static pyramid sensor went dead and quit providing data. In order to find another method of continuing the research, the reasoning was that a moving sensor could possibly continue providing data. Joe built an elaborate experimental

setup he named the "centrifuge". The centrifuge "pyramid motor" is illustrated in figure 7.2.2-1.

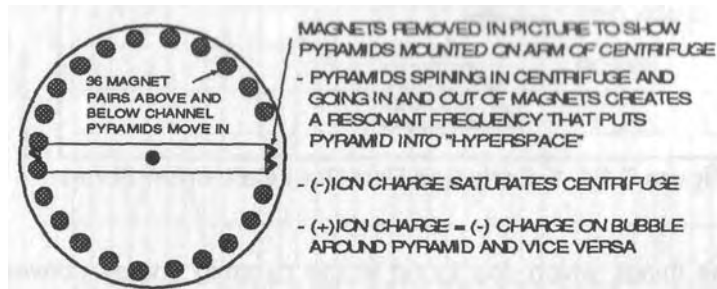

Figure 7.2.2-1 Joe Parr's Pyramid Centrifuge

Extensive experiments with the centrifuge provided additional data on the pyramid energy bubble. Positive ions in the centrifuge would cause the pyramid to be drawn to the polarity of the moon. Negative ions in the centrifuge would cause the pyramid to be repelled away from the moon. At certain times of the year (around December 8th-15th and May 8th-15th) the energy bubble around the pyramids in the centrifuge would become totally opaque to all local gravitation, electromagnetic, and inertial forces. When this happened, the little, one-inch-base pyramids would rip off the end of the centrifuge arm causing extensive damage to the interior of the centrifuge. Detailed analysis of the amount of energy needed to rip the pyramid free of its epoxy mounting, showed that an 8 gram pyramid had approximately 2000 pounds of force (i.e., 113,000 times increase in kinetic energy). It is hypothesized that the pyramid moves into a different time/space condition, which Joe called hyperspace, when the pyramid is in the alternating magnetic field. When the pyramid moves out of the alternating magnetic field of the centrifuge, the pyramid comes out of h-space with huge amounts of additional energy.

The centrifuge experiments also operated the same as the static pyramid in that putting radio frequency sources, radioactive sources, magnetic sources, and ion sources inside the pyramid showed that the energy of the energy sources was attenuated when in the pyramid energy bubble.

This method relies on pyramids mounted on the outside of a rotor which is rapidly rotated. An E-field perpendicular to the rotor is aligned with rotor axis. A magnetic field is aligned perpendicular to the axis of the rotor. Thus, when the rotor spins, the pyramids not only make and break

the E-field but have an alternating magnetic field at right angles to the E-field.

Analysis revealed detail in regard to alignment of the magnetic field with the pyramids. If the magnets cover the entire width of the rotor, then the electrostatic field gets generated in one direction on one side of the rotor axis and in the opposite direction on the other side of the axis. The question is: would this nullify the energy generation effect or does it make any difference since electrons are electrons???

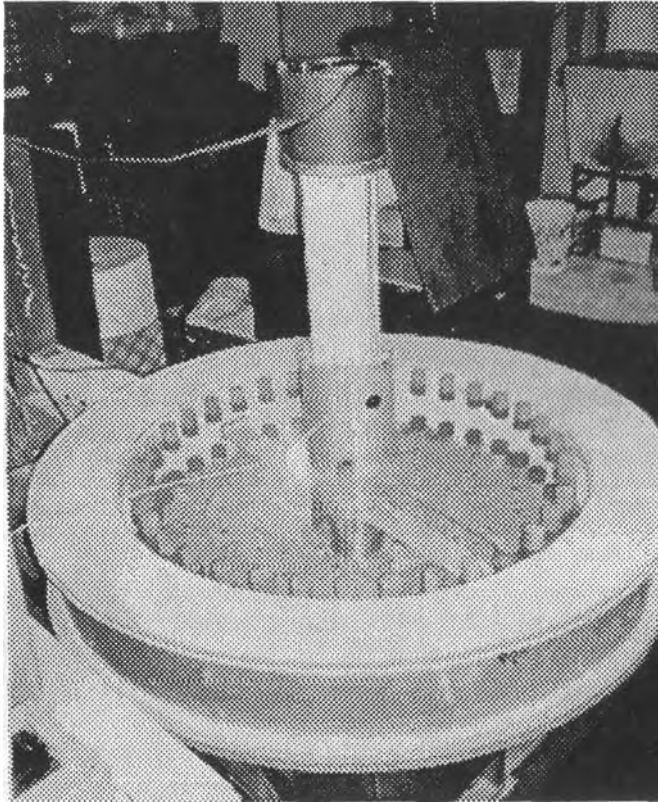

Figure 7.2.2-2 Photograph of Joe Parr's Pyramid Centrifuge

7.2.3 Joe Parr Gravity Wheel Experiments

The centrifuge research led Joe to hypothesize that perhaps a three-dimensional pyramid was not totally necessary. A new experiment was devised which replaced the large centrifuge assembly with a small specially designed wheel mounted *on* a shaft and spun by a small high speed motor.

He then developed a simpler dynamic experiment related to the centrifuge with a much simpler apparatus to perform experiments. This experimental setup is shown in figure 7.2.3-1. It is a four-inch wheel

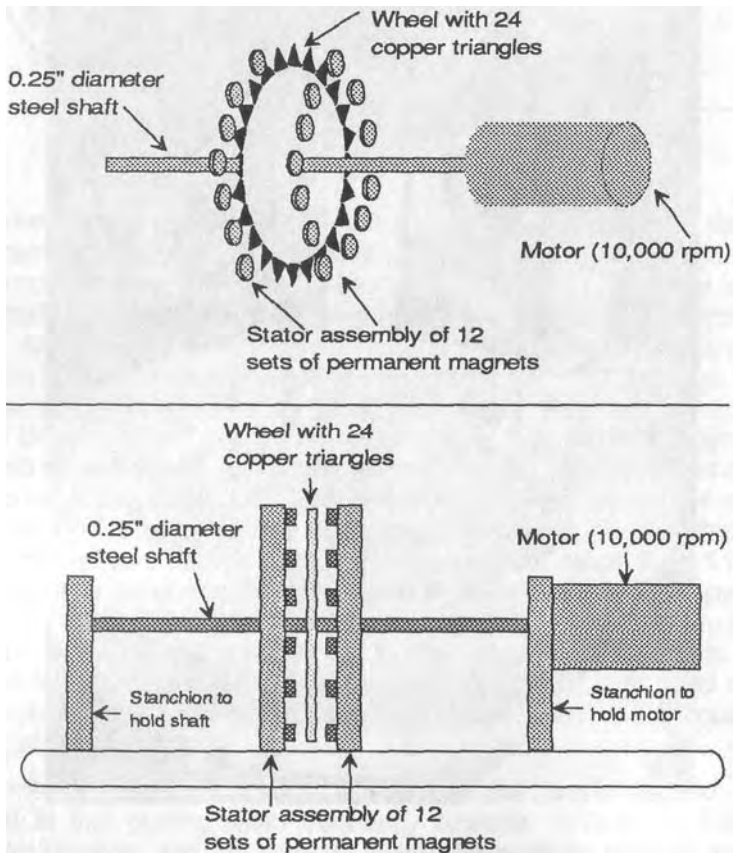

Figure 7.2.3-1 Rotor Using Triangles As Shape Power Collectors

made of printed circuit board material with 24 triangles, the shape of the great pyramid face, around the circumference of the wheel. The triangles are placed opposite each other on both sides of the wheel. The wheel, I have termed the gravity wheel, spins in between two stators which have low gauss (100 gauss each) ceramic magnets which are positioned so the edge of the magnet lines up with the 1/3rd height of

the triangles. An electrostatic ion generator is positioned next to the experiment to feed ions to the experiment. Gravitation bubbles or forcefields form around each of the triangles when the wheel is spun at high speeds. The ion generator is not shown in figure 7.2.3-1. Photographs of Joe's gravity wheel experiment are shown in figures 7.2.3-2 and 7.2.3-3.

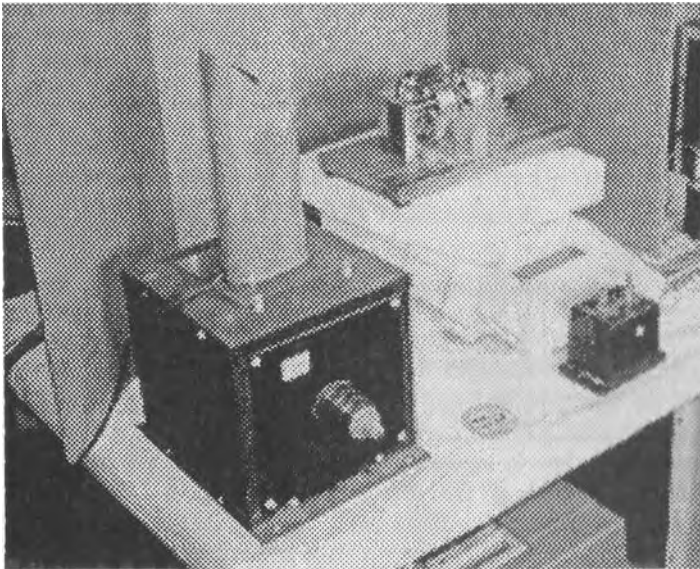

Figure 7.2.3-2 Joe Parr's Gravity Wheel Experiment

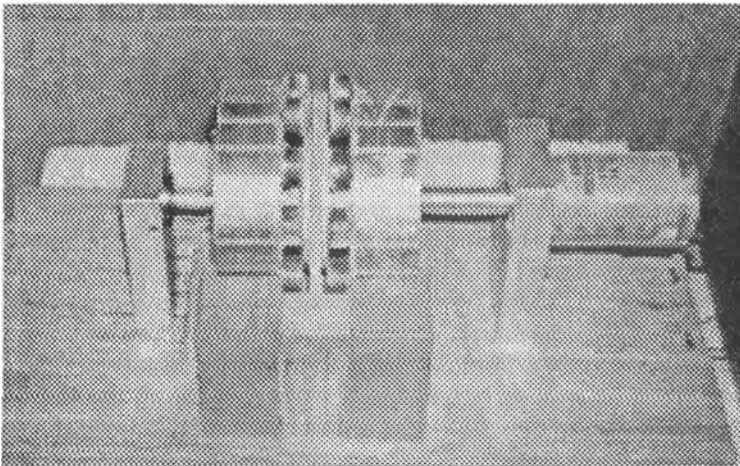

Figure 7.2.3-3 Close-up of Joe's Gravity Wheel Experiment

7.2.4 Force Fields Of The Gravity Wheel Experiment

The Parr experiments revealed the forcefields created by the spinning gravity wheel experiment and are depicted in figure 7.2.4-1. There are

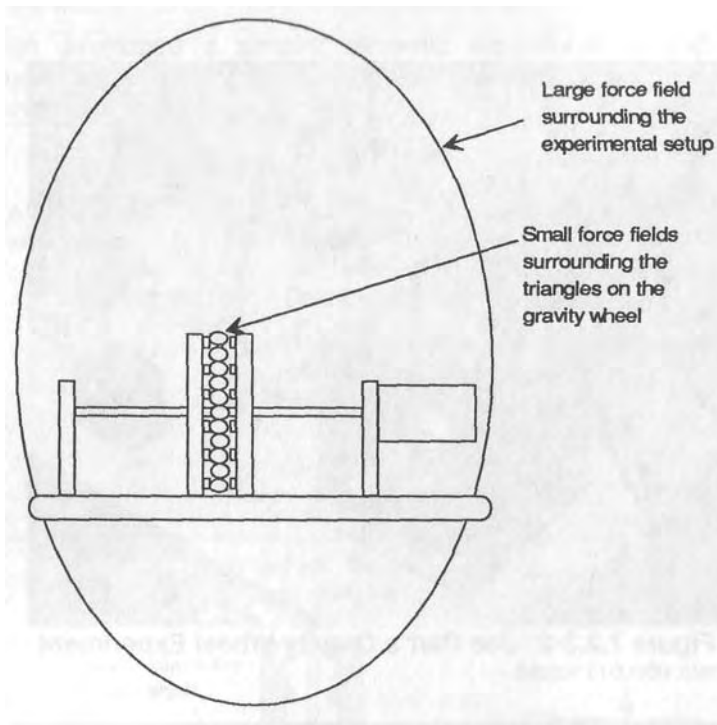

Figure 7.2.4-1. Ovoid Forcefield Around Gravity Wheel Experiment and Small Energy Bubbles Surrounding each of the Triangles of the Gravity Wheel

two types of forcefields built up in and around the experiment. There is an ovoid shaped forcefield around each of the copper triangles. When these small force fields build up in intensity, they cause a drag on the motor which can be plainly heard in the lab. There is a larger forcefield which builds up around the entire experiment setup. Tests done by Joe Parr using special instrumentation and a dowser, plus independent tests by the author with a clairvoyant and a clairsentient, all verify the large forcefield around the experimental setup plus the smaller forcefields around each of the triangles.

What Joe has discovered is that the earth moves through energy conduits which go from our sun to other planets and star systems.

When the gravity wheel experiment crosses one of these energy conduits, the forcefield around the copper triangles intensifies to the extent that the bubble goes opaque to all local forces and starts moving down the conduit very rapidly and a scale upset occurs. Attempts at simulating the energy conduit thus far have failed. We are in the process of evaluating the data and have found some correlation with planetary and stellar conjunctions when the earth is lined up with other planets or stars and our sun. The data analysis is currently in its infancy, but we are getting some very impressive gravitational effects.

7.3 Duplication of Gravity Wheel Experiments

The author had been following Joe Parr's experiments over several years; and after Joe had some initial success with the new experimental setup, the author, with Joe Parr's assistance, built a duplicate experiment.

7.3.1 Gravity Wheel Experimental Setup and Results

It took several months to get my version of the experiment to operate successfully. Tuning involved getting the experimental setup oriented properly and proper grounding. The shaft must be oriented east-west. A negative ion source is set within a few feet of the spinning wheel to feed the forcefields which form around the copper triangles affixed to the gravity wheel. The experiment is set on a delicate scale which measures accurate to 0.5 grams. The static weight of my experimental setup is about 1200 grams. Joe Parr's version is about 1800 grams. My experiment used machined maplewood to hold the motor and shaft, and the stanchions which hold the magnets and Parr's experiment was made of machined aluminum. A photograph of my gravity wheel experiment is shown in figure 7.3.1-1.

The main difference between my version of the gravity wheel experiment and Joe's is that Joe's burns out a motor at nearly every conduit and mine doesn't. Evidently, the interaction of the forcefield with the aluminum stanchions in Joe's version causes enough resistance to burn out the motor.

During experimental operations, the weight of the experiment can drop from 0 to -6.5 grams. When one considers that the gravity wheel with the copper triangles weighs about 12 grams, the total normal operational levitation effect is on the order of 50% weight loss. This by itself is a remarkable experimental effect and deserves acute attention.

The scale which is used in the experiment is an Ohaus Precision Plus purchased from Cole Parmer. The scale can measure accurately within 0.5 grams over a range of 0-4000 grams. The scale has an RS-232



Figure 7.3.1-1 Dan Davidson's Gravity Wheel Experiment

serial interface which allows the scale to be interfaced to a printer or computer. The scale outputs the weight continuously except when there is a scale upset. The upset weight can be varied and it was set at a maximum of 5 grams. This means that if the weight on the scale changes more than 5 grams within a couple of milliseconds, then the RS-232 interface stops outputting the weight as measured by the scale.

My preliminary hookup of the scale was to a computer; however, the intense forcefield which builds up around the experiment destroyed two computer interface cards. Since the RS-232 interface stops outputting data on a scale upset, the serial output of the scale was converted to a voltage level and used as an indicator. When the voltage drops, a scale

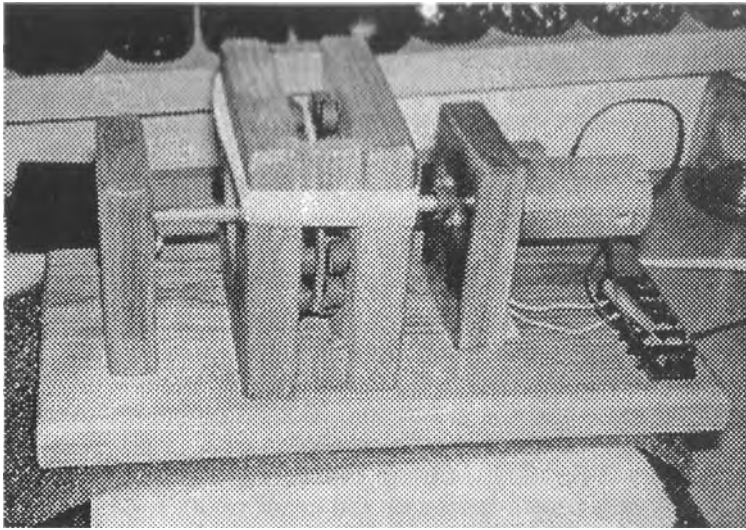

Figure 7.3.1-2 Close-up of Dan's Gravity Wheel Experiment

upset has occurred. The voltage level change was/is interfaced into a pulse counter. This provides a count of scale upsets greater than 5 grams. Figure 7.3.1-3 is a graph over time of scale upsets. This shows the count of when the gravity wheel changed weight over 5 grams. If the 6.5 gram weight loss is added to the 5 gram upset, we are looking at nearly a 100% weight loss of the gravity wheel. Both Joe Parr's gravity wheel experiment and mine got the same interstellar conduit on April 11, 1996.

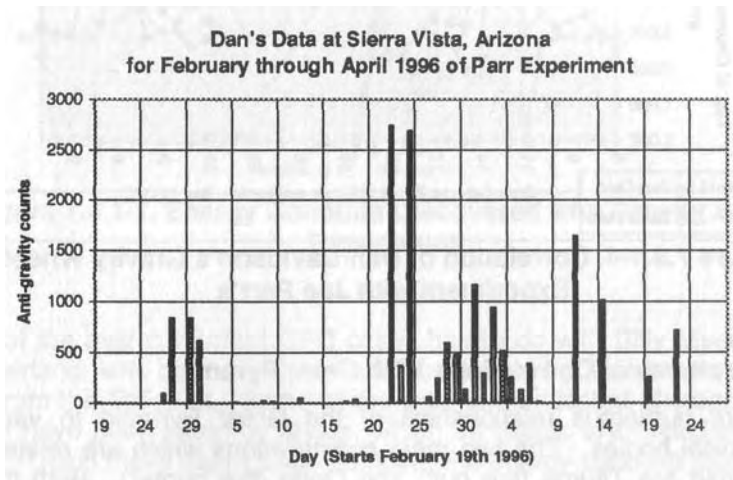

Figure 7.3.1-3. Data from Dan Davidson's Gravity Wheel Experiment

In the summer of 1996, we did a calibration of my experiment by comparison with Joe's experiment running in California. It turns out the magnets which I used were too strong. My magnets were replaced with ones which are approximately 100 gauss each. Apparently, if the magnets are too strong they override the energy conduit signal and the apparatus sensitivity drops drastically. This explains why on a given conduit, Joe's experiment would get 200,000 plus scale upsets and my experimental setup get only about 1500 upsets.

On a new set of experiments where my new sensor was calibrated to act like Joe's, both our experiments detected the same energy conduits. This is illustrated in figure 7.3.1-4. Joe Parr is located on the West Coast and my experiment is in Arizona. Both experiments recorded the same big energy conduits on December 12-14, 1996 and another conduit January 3-5, 1997. During these two conduit periods, I was getting momentary weight losses on the order of 30 to 64 grams. This means that the gravity wheel was getting a negative weight showing a total weight loss as high as 533%. Joe and I believe that these experiments mean we have the embryonic basis for a true space drive.

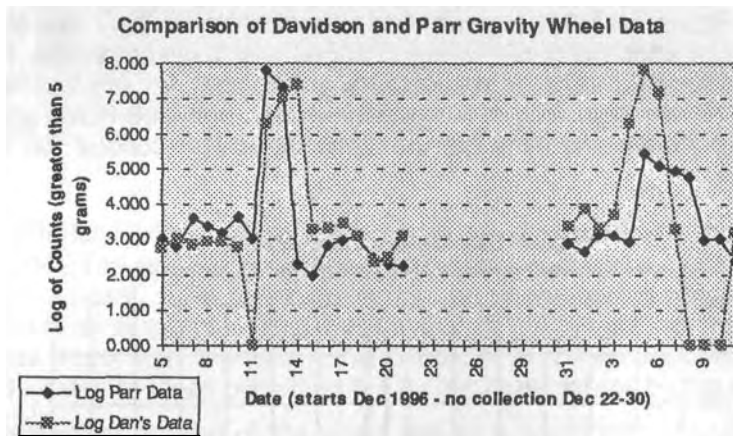

Figure 7.3.1-4. Correlation of Dan Davidson's Gravity Wheel Experiment with Joe Parr's

7.4 Astronomical Correlations With Great Pyramid

There are numerous relationships of the Great Pyramid to various astronomical bodies. The two main constellations which are related to the pyramid are Taurus (the bull) and Orion (the hunter). Both these constellations are in the same portion of the sky. Taurus is located just above Orion.

7.4.1 The Taurus/Pleiades Connection

The star Alcyone in the constellation Taurus marks the foundation setting (i.e., when construction was initiated on the Great Pyramid) date of the Great Pyramid.⁶ Alcyone is one of the brightest stars in the Pleiades, which is part of the Taurus constellation. The ascending passageway in the Great Pyramid has a score line on it which pointed to Alcyone in 2144 BC. Alcyone is lined up with the sun and just above it and the earth during the month of May. Figure 7.4.1-1, which depicts the major energy conduits, shows the May 2 conduit. Not shown on the chart was a conduit last year on the 27th of May, also an Alcyone correlation.

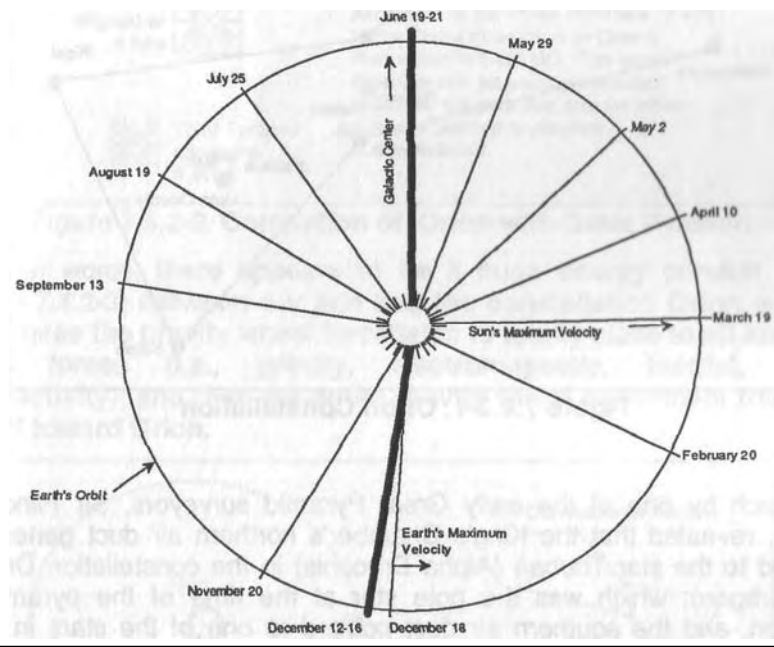

Figure 7.4.1-1. Energy Conduits Discovered with Gravity Wheel Experiment

One of the best confirmed UFO cases has to do with Billy Myers, from Switzerland, who claims to have been contacted by extraterrestrials who hail from the Pleiades. Some of the best authenticated photographs of UFOs have been taken by Myers, which he claims are Pleiadian beam ships. Could these beam ships be riding the energy conduits discovered by Joe Parr?

7.4.2 The Orion Connection

The big conduit in the middle of December, shown in figure 7.4.1-1, and first week of January loads to another important connection, that of the great pyramid and the Orion constellation (see figure 7.4.2-1).

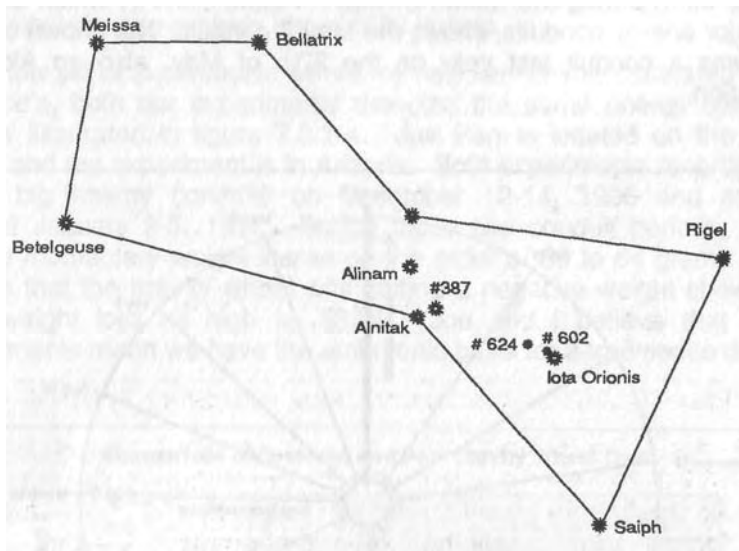

Figure 7.4.2-1. Orion Constellation

Research by one of the early Great Pyramid surveyors, Sir Flinders Petrie, revealed that the King's Chamber's northern air duct generally pointed to the star Thuban (Alpha Draconis) in the constellation Draco (the dragon), which was the pole star at the time of the pyramid's creation, and the southern air duct pointed to one of the stars in the constellation Orion's belt around 2600 BC.

More precise modern measurements⁷ have also shown that the King's Chamber's north and south air ducts and the Queen's Chamber southern air duct date the pyramid at 2450 BC. The details of this discovery by Bauval is depicted in figure 7.4.2-2.

It is interesting to note that the earth is lined up with the sun and the three stars in Orion's belt around the 13th-15th of December each year. In the first week of this year, 1997, at sunrise and sunset the sun was lined up with the three stars in Orion's belt AND with the axis of the gravity wheel experiment.

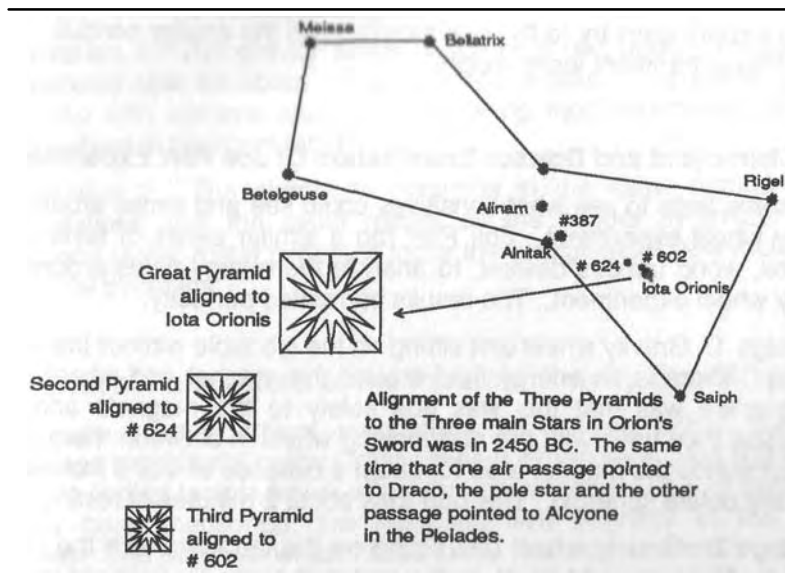
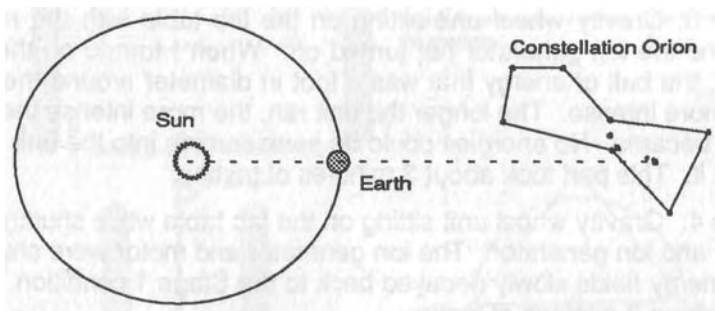

Figure 7.4.2-2. Correlation of Orion with Great Pyramid

In other words, there appears to be a huge energy conduit (see figure 7.4.2-3) between our sun and the constellation Orion which stimulates the gravity wheel forcefields to totally close to all known local forces (i.e., gravity, electromagnetic, inertial, and radioactivity); and then the entire gravity wheel experiment tries to lift off toward Orion.



During December and January, the sun, earth, and Orion are lined up. At sunrise and sunset, the axis of the gravity wheel experiment is lined up with the sun and Iota Orionis. This is the point of maximum antigravity effects.

Figure 7.4.2-3 Correlation of the Gravity Wheel Experiment with Constellation Orion

Did spacemen from Orion build the Great Pyramid? Is the energy conduit a communications and stellar stargate? Remember, the Parr gravity experiments try to fly (gravitate?) down the energy conduit. That is why the experiment loses weight.

7.5 Clairvoyant and Dowser Examination Of Joe Parr Experiment

I ran some tests to see what sensitives could see and sense around the gravity wheel experiment. Joe Parr ran a similar series of tests using Bill Cox, world famous dowser, to analyze the energy fields around the gravity wheel experiment. The results correlated perfectly.

Stage 1: Gravity wheel unit sitting on the lab table without the motor running. There is an energy field around the magnet and wheel area. The surmise was that this was due solely to the magnets and any interaction they have with the non-moving wheel in between them. The field surrounds the magnet area for about a distance of 4 or 5 inches in a generally oblate spheroid. This part took about 2 minutes of testing.

Stage 2: Gravity wheel unit sitting on the lab table with the motor running. As soon as I turned on the motor, the energy field around the assembly started to expand. The field grew to about 4 feet in diameter around the unit up to the wall and ceiling. The total field may go farther in extent but the wall and ceiling were in the way. I could distinctly feel the field around the gravity wheel. There was an intense bubble of energy around the unit about a foot in diameter that attenuated farther out. It appeared that there were streams of spiral energy coming off the experimental setup, but the spiral nature was not a certainty. This part took about 2 minutes of testing.

Stage 3: Gravity wheel unit sitting on the lab table with the motor running and the ion generator not turned on. When I turned on the ion generator, the ball of energy that was a foot in diameter around the unit became more intense. The longer the unit ran, the more intense the ball of energy became. No energies could be seen coming into the unit from outside of it. This part took about 3 minutes of testing.

Stage 4: Gravity wheel unit sitting on the lab table while shutting off the motor and ion generator. The ion generator and motor were shut off and the energy fields slowly decayed back to the Stage 1 condition. This part took about 3 minutes of testing.

7.6 Aluminum Pyramids and JP Energy Observations

Another quick series of tests was conducted using clairvoyants to look at the energy fields of aluminum pyramids I had machined. Experiments

included having the gravity wheel unit in operation. The following sequence took only 10 minutes of testing.

Observation 1. The gravity wheel experiment had been running fairly continuously now for about 10 days to two weeks. The entire garage was filled with aetheric energy with it being most intense around the gravity wheel experiment table.

Observation 2. The aluminum pyramids in the same numbers and configurations give the same results as the copper pyramids. The conclusion is that metal pyramids focus the energy more powerfully than non-metal pyramids.

7.7 Critical Parameters of the Pyramid Gravity Experiments

There are several critical parameters in building either the Parr Centrifuge experiment or the Gravity Wheel experiment. Joe spent over 14 years finding factors which affect the experiments. One of these has already been mentioned, the magnetic field intensity of the small magnets. The magnets which I used in my first version were too strong. Tests showed that the optimum magnetic field strength of the 0.5 inch ceramic magnets is 100 gauss each. Another factor is the alignment of the magnets with respect to the pyramids or triangles in the two experiments. Figure 7.7-1 depicts the optimum relationship of the magnets with respect to the triangle or pyramid.

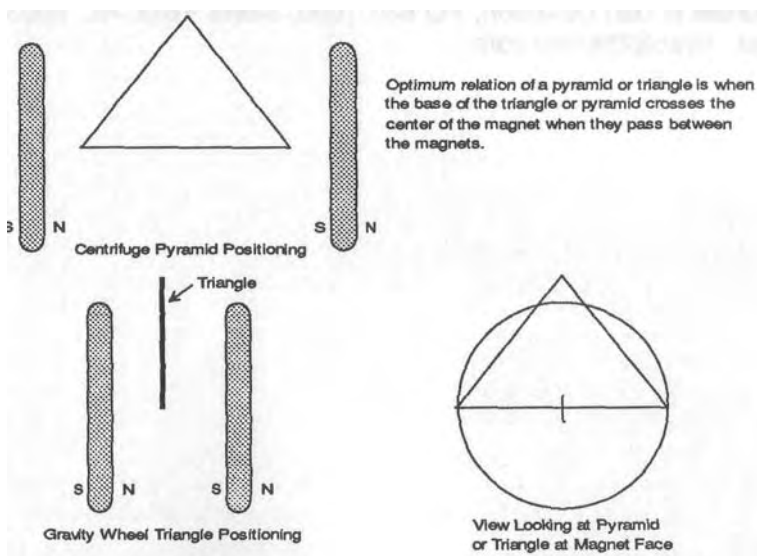

Figure 7.7-1. Optimum Magnet Positioning for Gravity Experiments

Both of Joe's experiments have triangles in that the pyramids in the first experiment have opposing facing triangles, and the toothed wheel in the second experiment has opposing facing triangles. Joe found that the toothed wheel would not work until the copper triangles were freed from touching each adjacent triangles. Touching was eliminated by putting a small slit between each triangle and removing the copper from the center of the toothed wheel.

7.8 Summary of Experimental Effects of Shape Power

The main theme from this chapter is that shape power produces measurable effects and can be measured with special sensors. The pyramid shape converts the aetheric forces to standard electrical and magnetic energies which are measurable by standard instrumentation.

The Parr experiments show that it is possible to generate anti-gravity forcefields using pyramids. These are macro level fields (i.e., the size of the experimental apparatus) rather than the tiny fields generated by the Townsend Brown effects where maximum effects are on the order of a less than 1 percent of the total weight. With the Parr gravity wheel experiment, we are getting effects 3 to 5 times the weight of the gravity wheel (i.e., the toothed wheel in the experiment).

Joe Parr and I would like to get more experimenters interested in duplicating the experiment for further correlation. Contact me if you are really serious about investing some time in duplicating the experiment. My address is Dan Davidson, PO Box 1090, Sierra Vista, AZ 85636, or email at: rivas@theriver.com

7.9 Bibliography

1. "Dielectrics as Gravity Wave Detectors", Dan A. Davidson, Proceedings of the 1991 Extraordinary Science Conference, sponsored by the International Tesla Society, Inc. PO Box 5636, Colorado Springs, Colorado, 80931, July, 1991.
2. Free Energy. Gravity, and the Aether. Dan A. Davidson, RIVAS, PO Box 1090, Sierra Vista, Arizona 85636,1996.
3. Transverse Paraphysics. Tesla Book Company, PO Box 1649, Greenville, Texas, 75401,
4. Unpublished notebook copy of Townsend Brown's research on gravity detectors using different conductivity materials in a wheatstone bridge circuit. Data varied daily with a great deal of noise/spikes in the data.
5. "All About Gravitational Waves", Greg Hodowanec, *Electronics*, April 1986.
6. The Great Pyramid. Its Divine Message. D. Davidson and H Aldersmith, London, William Rider and Son Ltd., 1924.
7. The Orion Mystery. Robert Bauval and Adrian Gilbert, Crown Paperbacks, 201 East 50th Street, New York 10022.1995.

CHAPTER 8

NUCLEAR STRUCTURE - BASIS OF SHAPE POWER

This chapter examines the shape power of subatomic structures.

8.1 Introduction

The atom is the ultimate, original, shape power structure. Its perpetual vibration and motion reveals that it operates at the interface of the physical universe with the aetheric realm. All known forces and elements are embedded in the structure of the atom, and probably many more that we don't yet know about. Solve how the atom does its perpetual motion miracle and you have solved how the physical universe is constructed. Gravity control and free energy will be some of the resulting developments when the atom is understood.

In chapter one, the simple atom, as envisioned by John E. W. Keely, was depicted as a torroidal vortex of aetheric force, with a substructure of torroids embedded within the larger torroid in a triple particle effect. The main torroid is made up of three smaller torroids rotating to form the larger main pattern, with each pattern repeating at each sub-level, possibly *ad infinitum*.

Modern physics envisions the atom as a collection of nuclear particles which are held together by the strong force, the weak force, gravity, electricity, and magnetism to form the various atomic elements. Their theory is that the center of the atom has a nucleus, a core of these subatomic particles, which is surrounded by a cloud of electrons orbiting the nucleus at tremendous speed.

Neither Keely's model without electrons nor the modernist view with their particle soup is a satisfying concept. Electrons exist, at least particles

that look like them, smell like them and quack like thorn, so Keely's model is incomplete or we simply don't have enough information to define it. Further, an electron or a cloud of them continuously rotating about the nucleus should quickly deplete their energy through electromagnetic radiation so we have more anomalies to deal with.

On the other hand, the particle menagerie of the "standard model" seems to exist but only for the most fleeting of moments. The stable particles (i.e., those which exist independent of the atom) are the electron, positron, proton, and anti-proton. Some might ask, "isn't the neutron a stable particle?"; observation shows it quickly decays into an electron and a proton.

A new model of the atom is emerging from the alternate science researchers that seems to satisfy experimental observations. This chapter describes this new atomic model. Atomic structure is described by this new model, and we are able to derive the nuclear and physical constants, plus the model forms the basis for a grand unified-field theory. None of the alternate science researchers, that I analyzed, including myself, have the full picture; but it looks like we are moving in the correct direction. I have endeavored to put all the parts together to have a more complete theory and form a cohesive picture of the atomic level and the basic nuclear forces. The researchers that formed the core ideas are listed in the bibliography.

The essence of this new model is that the electron, proton, positron, and anti-proton are all torroidal (i.e., donut shaped) shaped particles that rotate at the velocity of light. The neutron is the result of an electron and proton being compressed in the nucleus.

When I was first getting into a study of alternate physics and science back in the 1950's, my first brush with an alternative to the standard model of modern physics was with John E. W. Keely's torroidal structure of the nucleus. Having been educated ("brainwashed") by my classes in nuclear physics, atomic chemistry, and electronics, Keely's "atom" was a source of extreme puzzlement. On one hand, the evidence that Keely had truly discovered a certain modicum of control of gravity and magnetism was astounding (and way beyond modern physics), but I was never able to fully reconcile what he did with what he said was the physical basis for the atom. His atom was not adequately explained in the scant literature available and I couldn't make out if the particles Keely described were electrons, protons, neutrons, or what. My conclusion (circa 1959) was that Keely's concept of a torroidal particle structure was probably close but his subatomic structure was as goofy as the standard model. I decided that the short-lived subatomic particles were nothing more than the residue of a torroidal nucleus, made of the aether, getting blasted apart and the harder it got blasted the more strange the particle soup. Each succeeding, more powerful atomic

accelerator that physicists used to blast the nucleus found new particles to add to the particle menagerie, possibly particles from Keely's substructure of smaller and smaller torroids.

I am going to give a partial derivation of the mathematical formulas which describe the new alternate atomic model; however, if the reader wants to see the nitty gritty details, look into the articles listed in the bibliography at the end of this chapter. By and large, I have steered away from mathematical descriptions in preceding chapters and attempted to form a word and graphic depiction of the various elements of shape power to make this fascinating subject appealing, understandable, and usable to the serious researcher who may not have a mathematical background. In this chapter, I am going to show there is a very firm mathematical basis for this new physics. If math isn't your forte, then read the words and study the pictures, they tell the same story and you'll get 80% of the essential concepts.

My first real brush with the electron as a torroidal structure, that had some mathematics associated with it, was the seminal work done by Dr. Paramahansa Tewari^{1,2,3,4,5}. Subsequent modeling by Paul Stowe^{6,7} filled in more of the puzzle of gravitation, Dr. Hal Puthoff⁸ and MI associates clarified the concept of inertia, and recent work by Lucas and Bergman^{9,10,11,12} solves another set of my questions about the nucleus and atomic structure and how the structure goes together geometrically. What follows is a unified concept of these. I don't pretend that this is the end of the discussion of nuclear structure, but at least its a place to start developing a new, rational structure of matter and the universe, and to form a theoretical basis for a new picture of shape power research efforts.

8.2 The Torroidal Electron

Space is envisioned as a superfluidic medium, nonviscous, relatively frictionless, massless and continuous. It can be modeled as a paniculate superfluid with average interaction spacing of L . Essentially, this is a new definition of the aether.¹

The electron is postulated as a torroidal (i.e., donut shaped) ring. The ring with a radius of R and a cross section of r , rotates with a velocity of c , the speed of light. The ring (or more properly the toroid) also rotates within itself around the cross-section with radius r . The electron's electric charge and associated electrostatic field properties can be shown to be a result of the two rotations of the ring on it axis and cross-section.

In the classical theory of kinetics, the transverse wave speed in a fluid is:

$$c = \sqrt{\frac{P}{\rho}} \quad (1)$$

Where P is the pressure and ρ is the fluid density.

From electrostatics the velocity of light, c, is related to the permeability μ_0 , and the permittivity ϵ_0 of free space. The relationship is:

$$c = \sqrt{\frac{1}{\mu_0 \epsilon_0}} \quad (2)$$

Equating (1) and (2):

$$\frac{P}{\rho} = \frac{1}{\mu_0 \epsilon_0} \quad (3)$$

Since light is a transverse phenomena, we find that $\mu_0 = 1/P$, the coefficient of compressibility, and $\epsilon_0 = \rho$ which is mass/density.

To find Plank's constant we define a field vector entity as follows:

S = Space

V = Velocity

Z = momentum

L = average movement or mean free path

t = rate of momentum

h = action parameter

m_z = mass or apparent mass and $Z = m_z V$ (from kinetics)

There are n of these entity vectors in a given space. The action parameter is defined as follows:

$$h = 2 Z \int_0^L dh = 2 Z L \quad (4)$$

Substituting for $Z = m_z V$,

$$h = 2 m_z V L$$

The total energy of the system is the integral:

$$E = n \int_0^t h dt = n h t \quad (5)$$

The rate t is V for wave velocity and c (i.e., the speed of light) for electromagnetic radiation.

Thus:

$$E = h V \text{ for wave motion} \quad (6)$$

$$E = m_z c^2 \text{ for relativistic energy} \quad (7)$$

Since equation 6 is the same as the energy in an electromagnetic wave, then h is Plank's constant.

The quantity of charge relates to the charge of an electron. The electron is defined as a torroid with area $a = 4 \pi^2 R r$ and volume $S = 2 \pi^2 R r^2$ where R is the large torroidal radius and r is the cross-section radius. The electric charge e of the electron is the total momentum Z of the electron which is spread over area per unit volume. In equation form this is:

$$e = Z 4 \pi^2 Z L / 2 \pi^2 Z L^2 = 2 Z / L \quad (8)$$

Since $h = 2 P L$ and $e = 2 Z / L$ then:

$$L = \sqrt{\frac{h}{e}} \quad (9)$$

Electric charge e , with a value of $\pm 1.6029 \times 10^{-19}$ kg/sec, is the local divergence of the aetheric field and is related to μ_0 and ϵ_0 as follows.

$$q = \frac{1}{2\pi} \sqrt{\frac{h}{\frac{3\mu_0}{\epsilon_0}}} \quad (10)$$

The charge of an electron, the Rydberg constant, and gravitational constant are also derivable from simple fluid mechanics^{1,2} treatment of the aether. See table 1, page 119, for a summary of the simple relationships of the basic atomic and electrical constants as derived using fluid mechanics and treating aether as a superfluidic particulate medium.

Analysis of the proton leads to the conclusion that it is also an aetheric torroidal vortex, rotating at velocity c , with a different radius and ring cross section^{3,4}. The proton torroid, when it is broken up, devolves into a substructure which is made of three quarks, also torroids, which spin as a complete whole to form the proton. It is theorized that the quarks are not self-stable particles so dissipate rapidly.

Table 8.1-1. Functional relations of fundamental units (1 of 2)

| QUANTITY | NAME | RELATION TO KNOWN CONSTANTS | VALUE | UNITS | RELATED FUNCTIONS |
|--------------------|--|--|--|------------------------|---|
| q or Q | Elemental charge | $q = \frac{1}{2\pi} \sqrt{\frac{h\epsilon_0}{\sqrt{3}}}$ | $\pm 1.602E-19$ | kg/sec | $q = \text{DIV } P$ Charge is local divergence of aetheric field |
| h | Plank's constant | $h = \frac{\sqrt{3} (2\pi q)^2}{\epsilon_0 c}$ | $6.624E-34$ | kg m ² /sec | $\alpha = \frac{1}{8\pi^2 \sqrt{3}} = 1/137$ fine structure constant |
| K_R | Rydberg's constant | $K_R = \sqrt{\frac{q}{2h}}$ | 10986593.8 | m ⁻¹ | graininess of aetheric particle field |
| ν or λ | frequency of matter or wavelength (only for very light elements) | $\nu = \frac{q}{mp}$ $\lambda = \frac{c \cdot mp}{q}$ | for hydrogen $\lambda_e = 1.87E-3$ $\lambda_p = 3.91m$ | hz m | λ_e for electron yields 2.73 °K λ_p for proton yields 1.64E-3 °K |
| V | volt | $V = IR$ | variable | m ² /sec | measure of differential velocity in distance |
| R | resistance | $R = \frac{V}{I}$ | variable | m ² sec/kg | |

Table 8.1-1. Functional relations of fundamental units (2 of 2)

| QUANTITY | NAME | RELATION TO KNOWN CONSTANTS | VALUE | UNITS | RELATED FUNCTIONS |
|--------------|----------------------------|---|-----------------------|--|--|
| I | current | $I = \frac{V}{R}$ | variable | $\frac{kg}{sec^2}$ | rate of change of charge (mass flow) |
| E | Energy | $E = VI$ | variable | $m^2 kg/sec^3$ | Energy = mass flow x voltage |
| m T | Gauss | | unity | m=CURL P where P = momentum or pressure | Magnetic field strength, magnetic fields are curl or rotation of aetheric field |
| ϵ_0 | permittivity of free space | | 8.854E-12 | kg/m^3 | density of the aether |
| μ_0 | permeability of free space | $\mu_0 = \frac{1}{P}$ | 1.257E-6 | $\frac{m \cdot sec^2}{kg}$ | inverse energy density or inverse pressure of aetheric field |
| c | speed of light | $c = \sqrt{\frac{1}{\mu_0 \epsilon_0}}$ | 2.99E+8 | m/sec | $c^2 = \frac{\langle v^2 \rangle}{\sqrt{3}}$ $\langle v^2 \rangle$ average velocity of aether |
| G | gravitational constant | $c^2 \mu_0 \epsilon_0$ | $6.67 \cdot 10^{-11}$ | $\frac{newton \cdot m^2}{kgm^2}$ | the force of gravity is GRAD E |

8.2.1 Physics of the Torroidal Electron

When John Keely (circa 1896) first proposed the torroid structure of the nucleus, physics was just starting to get a handle on electrostatics and had only a glimmer of nuclear structure. The electron was discovered in the 19th century by J. J. Thompson in his famous water drop experiment. Since then, various models of the electron have been proposed, but up until the last 10 years none have come up with a physical model which agrees with experimental observation. The current quantum models are mathematical models, which are forced to agree with experimental evidence, but do not explain the electron's physical structure. In the previous section, I used the torroid model to show that it agreed with the charge structure. In this section, I will borrow from Bergman's excellent analysis of the torroidal structure to derive the physical parameters of the electron.

Again, the electron is assumed to be a ring with uniform current and surface charge density. The electron ring is a stable torroidal vortex made of aether rotating at the speed of light. A pictorial of the ring and its dimensions and forces is shown in figure 8.2.1.1-1 and the aether flow (i.e., the magnetic field) is shown in figure 8.2.1.1-2.

The ring has charge e (i.e., the electron charge value) and is distributed uniformly over the surface with charge density of σ and is moving with velocity c , the speed of light. Since the ring has no mass but is a current of electrostatic force, the ring can move at light speed without violation of mass/velocity principles. In fact, since the ring is electromagnetic, em forces move at c anyway. The area, a , of the ring is $4\pi R^2$. Thus,

$$e = \sigma 4\pi R^2 \quad (11)$$

The energy E_e of the ring is from classical electrostatics¹³.

$$E_e = e^2/2C \quad (12)$$

Where C is the capacitance of the ring, the inductive or magnetostatic energy E_m is also derived from classical electrostatics.

$$E_m = Li^2/2 \quad (13)$$

L is the self inductance with current i of the ring. The current is also from classical electrostatics and is:

$$i = ec/2\pi R \quad (14)$$

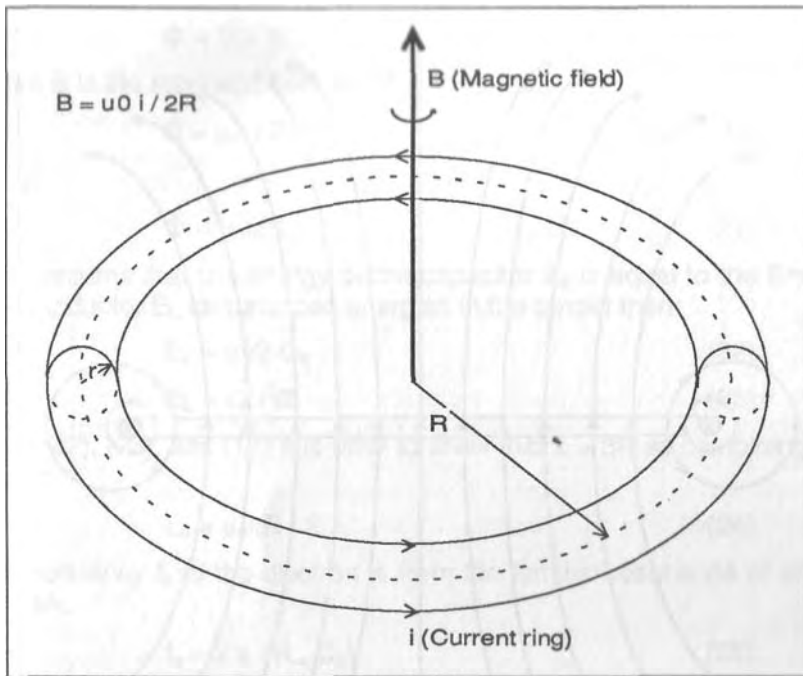

Figure 8.2.1.1-1. Torroidal Electron Structure

It is thus seen that the electron, as a toroid ring, has both magnetic and electric fields as well as a magnetic moment caused by the ring spin. The magnetic field is shown in figure 8.2.1.1-2 and the electric field radiates from the ring in all directions. This sets up a push-pull relationship to the surrounding space. The electric field will attract or repel e-fields of like polarity and the magnetic field will do likewise for b-fields.

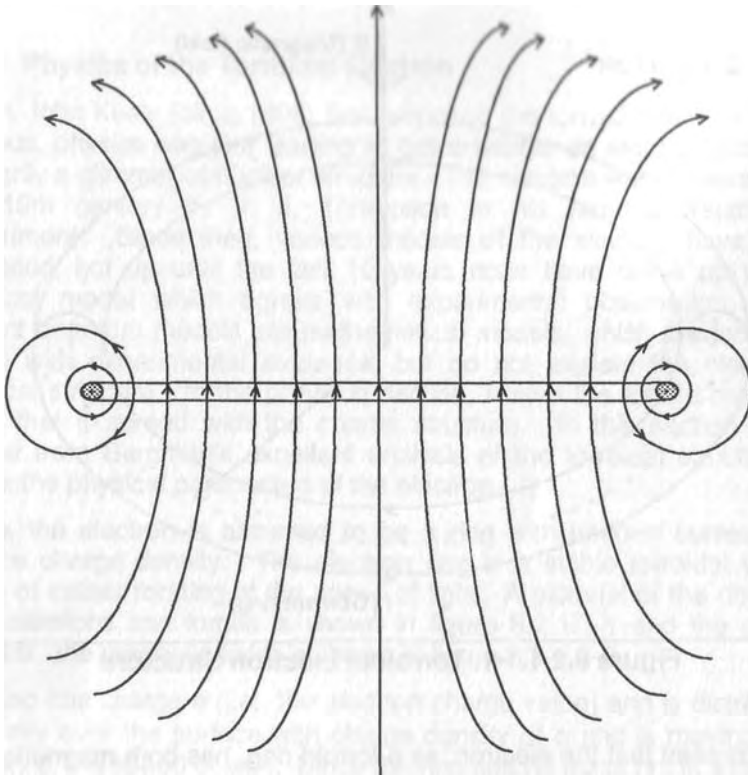

Figure 8.2.1.1-2. Side View of Toroidal Electron with Aether Flow (i.e., the magnetic field)

For a very thin ring where $r \ll R$ the voltage V is computed as follows:

$$V = 1/(4\pi\epsilon_0) (e/(x^2 + R^2)^{1/2}) \quad (15)$$

Capacitance $C_e = q/V$ (from Sears¹³: "Electrostatics") but $q = e$ so

$$C_e = e/V \quad (16)$$

Combining 15 and 16:

$$C_e = 4\pi\epsilon_0(x^2 + R^2)^{1/2} \quad (17)$$

The inductance of the ring L_e is:

$$L_e = N\Phi/i \quad (18)$$

where N is number of turns, Φ is the flux and i is the current. $N = 1$, and Φ is:

$$\Phi = B \times A \quad (19)$$

where B is the magnetic field and A is the area.

$$B = \mu_0 i / 2R \quad (20)$$

Thus:

$$\Phi = \mu_0 i \pi R / 2 \quad (21)$$

If we assume that the energy of the capacitor E_c is equal to the Energy of the inductor E_L for balanced energies in the torroid then:

$$E_c = e^2 / 2 C_e \quad (22)$$

$$E_L = L_e i^2 / 2 \quad (23)$$

From (22), (23), and (17) it is easy to show that $x = 3R$ so combining the above:

$$L_e = \mu_0 \pi R / 2 \quad (24)$$

The frequency f_e of the electron is from the familiar resonance of an LC network:

$$f_e = 2 \pi / (L_e C_e) \quad (25)$$

Combining (17), (22), and (23) yields:

$$f_e = c / R \quad (26)$$

From Menzel¹⁴ the Compton wavelength f_c is:

$$f_c = mc^2/h \quad (27)$$

where c is speed of light and h is Plank's constant. Combining (26) and (27),

$$R = h / mc \quad (28)$$

This is the large radius, R, of the electron.

The anomalous magnetic moment can also be computed from this model of the torroidal electron. The ring current i is $i = e\omega/2\pi$ where ω is the angular velocity which is c so

$$i = ec/2\pi R \quad (29)$$

Magnetic u_e is:

$$u_e = Ai \quad (30)$$

where A is the area of the current torroid. Combining (28), (29), and (30) yields:

$$u_e = he/4\pi m = u_B \quad (31)$$

where u_B is the Bohr magneton. Computation of this yields:

$u_e = 0.92731$ which is good to 3 decimal places.

The anomalous electron moment correction¹⁴ is:

$$(1 + \alpha/2\pi - 2.973\alpha^2/\pi^2) = u_e/u_0 \quad (32)$$

where α is the fine structure constant and $\alpha = 7.29729 \times 10^{-3}$. When this correction is computed:

$$u_e = 0.928381$$

which is good to 6 places for the Bohr magneton. More accuracy can be achieved by using a better approximation for the inductance L_e and the toroidal shape which is done in Bergman's analysis.

The main point to be made from all this is that the toroid electron model yields good results which are not achievable with classical or quantum mechanics. The other important point is this entire analysis obviates the need for Einstein's theories of relativity since we can derive all the atomic parameters without Einstein's nonsensical assumptions. Lets hope the orthodox community gets with the program and wakes up.

A summary of the torroid model equations and values are shown in table 8.2.1.1-1. This table also shows the values for the positron, proton, and anti-proton. The proton is related in size by the proton mass to the electron mass ratio of 1836.15. The proton is 1836.15 times more massive than the electron so its magnetic moment, radius, rotation, and current are similarly affected. Appendix B summarizes part of the nuclides of the atomic structure as based on the toroidal particle theory. It is seen that this corresponds perfectly with known electron- and proton-measured values.

Table 8.2.1.1-1 Values of Elementary Stable Particles ($\kappa = 1836.15$)

| PARAMETER | SYMBOL | EQUATION | UNITS | VALUE for ELECTRON | ELECTRON FACTOR | POSITRON FACTOR | PROTON FACTOR | ANTI-PROTON FACTOR |
|-----------------------|----------|-------------------------|-----------------|-----------------------------|-----------------|-----------------|---------------|--------------------|
| Charge | e | e | Coulomb | $1.6021892 \times 10^{-19}$ | -e | +e | +e | -e |
| Radius (large) | R | $R = h/mc$ | Meter | 3.86607×10^{-13} | R | R | R/κ | R/κ |
| Radius (crosssection) | r | r | Meter | 7.42214×10^{-200} | r | r | r/κ | r/κ |
| Rim velocity | c | c | Meters/se cond | 2.9979×10^8 | c | c | c | c |
| Rotation | ω | c/R | Radians /second | 7.7545445×10^{20} | ω | ω | ω | ω |
| Current | i | $\omega e/2\pi R$ | Ampere | 19.77357 | -i | +i | $+\kappa i$ | $-\kappa i$ |
| Spin (normalized) | s_e | $h/2$ | Joule-sec | $1.0545887 \times 10^{-34}$ | s_e | s_e | s_e | s_e |
| Capacitance | C | $C = 2\pi\epsilon_0 /R$ | Farad | 3.12812×10^{-25} | C | C | C/κ | C/κ |
| Inductance | L | $L = \mu_0\pi R/2$ | Henry | 2.0891×10^{-16} | L | L | L/κ | L/κ |
| Compton frequency | f | $f_e = c / R$ | Hertz | 1.23703×10^{20} | f | f | κf | κf |

8.3 Atomic Structure

Atomic structure builds according to the rules of geometry and the polarity of atomic particles.^{4,7,8} Polarities are the result of aetheric flows into and out of matter where the flow directions produce the magnetic poles. John Ernst Worrel Keely was the first sub-atomic physicist as he characterized the nuclear structure. His basic elucidation of atomic structure was derived from his development of the science of vibratory physics. One of his discoveries was that of the substructure of the proton¹⁵. He discovered it was a particle made of three sub-nuclear particles. Further research led him to the idea that this three-particle substructure continued down to smaller and smaller level of particles within each particle. Keely claimed to have learned to control the substructure 27 levels down from the basic proton. The Keely atom is depicted in a stylized format in figure 8.3-1. Keely's atom was closer to spherical shells than torroids. The first level of substructure was finally theorized in the orthodox community by Feynman in 1958. Keely's discovery antedated Feynman by over 60 years! Feynman called the three particles making up the proton, "quarks".

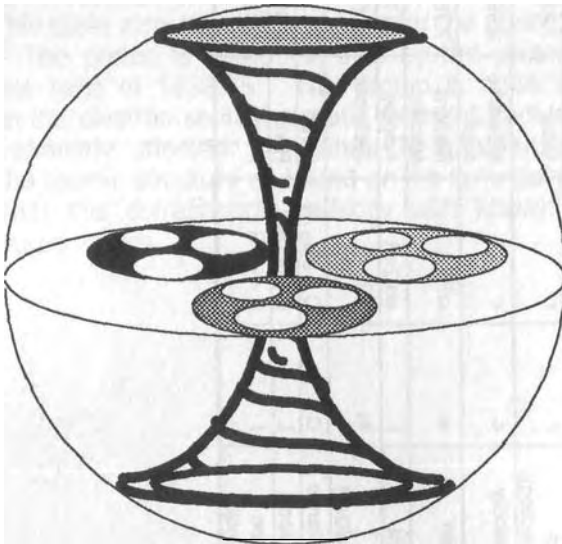

Figure 8.3-1. Keely "Atom" (i.e., Proton) Showing Torroidal Structure

Figure 8.3-2 depicts the torroidal atomic structure of two hydrogen atoms combined to form the hydrogen molecule (i.e., H_2) with two electrons and two protons.

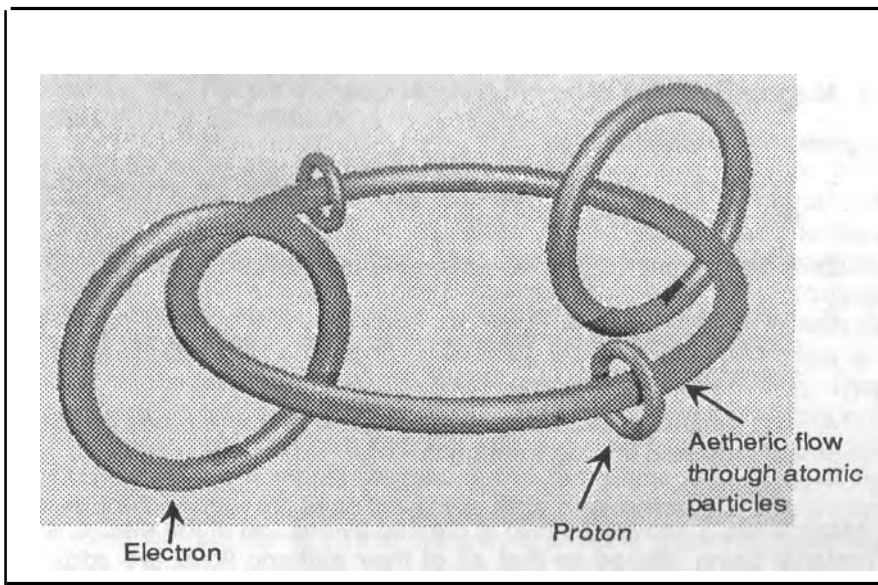

Figure 8.3-2. Torroidal Hydrogen Molecule H,

Figure 8.3-3 depicts the torroidal atomic structure of a helium atom with two electrons, two neutrons, and two protons. The neutron, according to Bergman, is really a combined electron and proton since neutrons decompose upon release into an electron and proton. At the nuclear level, the protons and neutrons are continually changing back and forth into each other. The helium atom acts like four neutrons because the two electrons and two protons operate like two more neutrons.

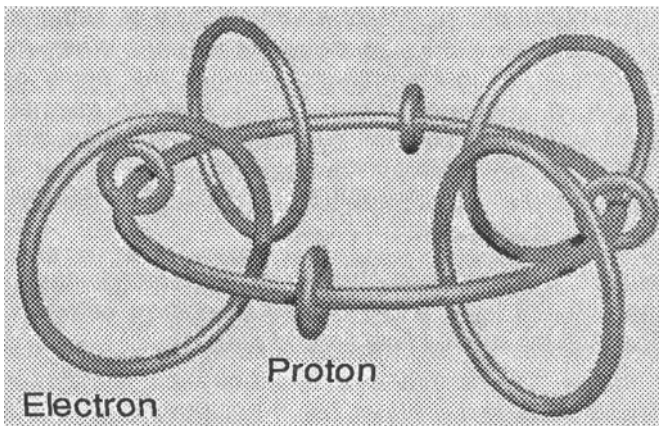

Figure 8.3-3. Torroidal Helium Atom

8.4 Magnetism

Magnetism is existent as:

1. The earth's natural magnetic field theorized to be created by the flow of the earth's liquid core.
2. A permanent magnetic field around magnetized materials
3. Either static or alternating magnetic fields around current-carrying wires where the current is either direct current (DC) or alternating current (AC), respectively.
4. The magnetic field of an electron toroid ring which has the local aetheric field flowing through it.

In cases 2 and 3 above, the field is created by enough of the electrons in a material being aligned so that all of their aetheric flows are additive and create a large flow of aether in the area around the magnet. So we see that magnetic fields are all the result of case 4 above (i.e., vortical flows of the aether).

The strong polarity of magnets is due to the concentration of the aether flowing through the poles. Tests, conducted by the author with clairvoyants, have verified that a magnet is essentially an aether pump.

Magnets have an energy flowing around them, as I and many other new science researchers have postulated. My laboratory experiments plus experiments with clairvoyants have proven that the magnetic field around a permanent magnet is in fact a vortical flow of aetheric force. The atoms act as aetheric pumps to move the aether. When many of the atoms are lined up, as in a permanent magnet, the atoms' aetheric flows all add together to create a large flow around the magnet. The seminal research, in the last century, by Baron von Reichenbach using clairvoyants, studied the energies around magnets. One of the observations they made was that there was blue energy at the north pole and red energy at the south pole.

Holding permanent magnets will charge up a person's aura. Two magnets facing NS-SN have a big bubble of energy between them. Shape power can tap the energy flow around magnets.

8.4.1 Gravity

As summarized in table 8.1-1, the gravitation constant, as grad E , correlates with the seminal work by T. Townsend Brown. Brown discovered that a capacitor will tend to move in the direction of the

positive plate. Apparent weight loss is the result when the plates are perpendicular to the local gravity gradient. This effect can be enhanced by making one plate much smaller than the other plate. This essentially forces the grad E to maximize.

It should be noted that grad E is independent of whether the field is AC or DC. Experiments have shown that even with this enhancement the capacitor does not have all its apparent weight nullified and levitate. The reason for this can be found again in the nuclear particle's relationship with the aether. Even though each atom is in constant resonance with the aether, this resonance is not synchronized across the mass ¹⁶. Each atom is doing its own thing, so to speak, and there is a random interchange with the aether with respect to all the nuclei. Thus, when a grad E facts as an aether pump across the capacitor plates, only a small portion of the atoms become synchronized to this aetheric flow so the entire mass does not respond at the same time; therefore, all the atoms don't try and move at the same time. An interesting experiment suggested by Paul Stowe to test the grad E effect is shown in figure 8.4-1.

Analysis of various, apparently disconnected, events where levitation was witnessed provides some important clues to a means of effecting synchronization of the nuclei. This was explained, in detail, in a paper by Davidson and Decker ¹⁶. Synchronization of the nuclei with the aether has been achieved by two main methods; namely, rotation or movement and sonically.

Townsend Brown was quite open in publicizing his experimental results even though they were being funded in part by the Office of Naval Research out of San Diego. However, when he started rotating his gravitors on their axis, the results suddenly became classified and all information on his experiments ceased. It is suspected that major levitation resulted and this breakthrough was classified to protect the discovery so it could be exploited for "national defense".

Analysis of the phenomenon of inertia provides the major clue to how rotation could act to synchronize the flow of aether into the nuclear sub-structure of the gravitors. Haisch, Rueda, and Puthoff ⁸ theorize that inertia is a result of mass's resistance of movement through the zero point energy (ZPE) field (i.e., the aether) because the mass, at the nuclear level, is linked directly into the aether. Puthoff and his friends did a nice proof of what Keely stated, in 1896, that inertia was a result of the resistance of mass to the local aetheric field. Hence, it is easy to see that movement/rotation could cause the aetheric flows of the mass to reorient with respect to the direction of movement.

Sonic stimulation performs the same thing by getting all the atoms of the mass to resonate together which synchronizes aetheric flows into the

nucleus. Several interesting levitation effects have been observed where sonic stimulation assisted in the levitation.

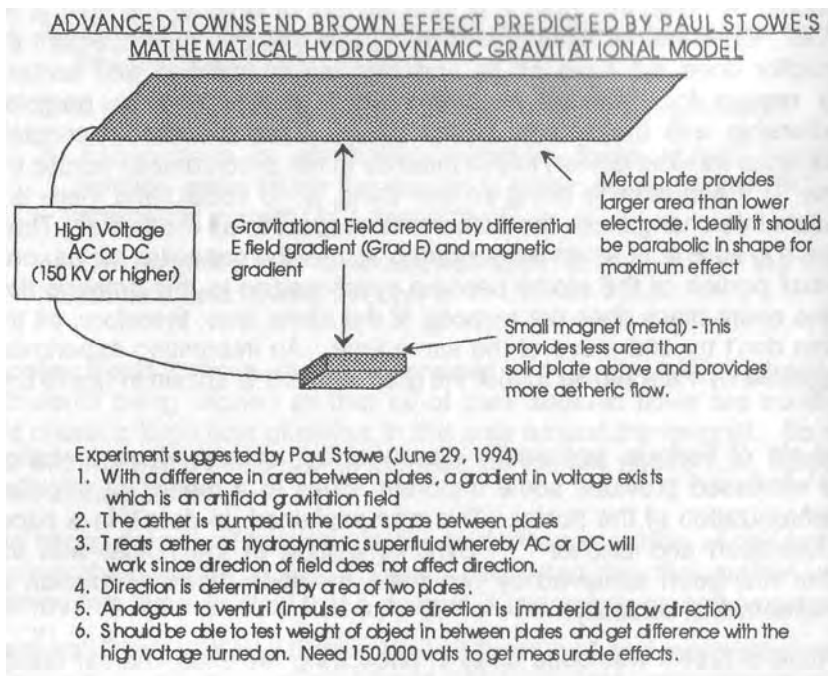

Figure 8.4-1. Paul Stowe's Experiment to Test Hydrodynamic Gravity Model

8.5 Summary of Nuclear Structure

A new model of the atom has been presented in this chapter. The old idea of electrons rotating around the nucleus has been dispensed with and replaced by a four-basic-particle-structure where the particles are torroids of the aether rotating at the speed of light. The aether is modeled as a superfluid. Using these concepts, we can easily derive the atomic constants and account for the atomic structure and derive the basic morphology of the various elements in the periodic table. The current orthodox view of atomic structure cannot do this. By the principle of Occam's razor, the simpler model should be the prevalent view.

8.6 Bibliography

1. "Space is the Absolute Reality", Dr. Paramahansa Tewari, International Conference on Space-Time Absoluteness, Genoa, Italy, July 1982.
2. Beyond Matter. Dr. Paramahansa Tewari, Printwell Publications, 1984.
3. "Detection of Stationary and Dynamic Space Substratum", Dr. Paramahansa Tewari, Raum un Seit. Vol 2, No. 1,1990.
4. "Interaction of Electron and Magnetic Field in Space Power Generation Phenomenon", Dr. Paramahansa Tewari, Magnets In Your Future. Vol 2., No 12, December 1987.
5. "Detection of Stationary and Dynamic Space Substratum", Paramahansa Tewari, Raum un Zeit. vol 2, no. 1,1990.
6. "A Definition of Electric Charge", Paul Stowe, 243 Bentley Court, American Canyon, California, 94589, May 2,1993.
7. "The Cause of Gravity", Paul Stowe and Barry Mingst, 243 Bentley Court, American Canyon, California, 94589, April 28, 1991.
8. Haisch, Rueda, and Puthoff , *Physical Review*, 1994, pages 678-694.
9. "New Spinning Charged Ring Model of the Electron", David L. Bergman, Twin-Cities Creation Conference, July 29-August 1,1992.
10. "Spinning Charged Ring Model of Elementary Particles", David L. Bergman, *Galilean Electrodynamics*, March/April 1991.
11. "A Physical Model for Atoms and Nuclei", Joseph Lucas, *Galilean Electrodynamics*, January/February 1996.
12. "Physical Models for Elementary Particles, Atoms and Nuclei", David L. Bergman and Charles Wm. Lucas, Jr., IV International Conference: Problems of Space, Time & Motion, Saint Petersburg Russia, September 23-29, 1996.
13. Electricity and Magnetism. Francis Weston Sears, Addison-Wesley Publishing Company, Reading Mass., 1946.
14. Fundamental Formulas of Physics. Donald H. Menzel, Dover Publication, Inc., 1960.
15. Dashed Against the Rock. William J. Colville, Boston: Colby and Rich, 1894. Colville was a close friend of John Keely and this book is a publication of Keely's secrets embedded in a metaphysical novel.

16. "Mass Resonance: Another Secret of Anti-Gravity . Dan A. Davidson and Jerry Decker, *Extraordinary Science*, April-May-June, 1995.

CHAPTER 9

EGYPT—RESEARCH EXPEDITION

9.1 1997 Shape Power Research Expedition to Egypt

From May 26 through June 6, 1997, Joe Parr, Jerry Decker, and myself will be on a research expedition in Egypt to perform various experiments on-site at the Great Pyramid. This chapter details the background and expectations of that expedition.

9.2 Egyptian Expedition Overview

There are three main purposes for this research expedition:

1. Test sonic control of the forcefield around the Great Pyramid. This experiment is designed to turn the pyramid's forcefield on and off. Doing this will cause the pyramid and its attendant forcefield to act as a signaling device to signal the galaxy that we have broken the code on what we believe the pyramid was originally used for; namely, an interstellar communication device.
2. Measure the magnetic and electric fields in and around pyramids and other sites.
3. Visit various historic Egyptian monuments and ancient sites to collect data on possible evidences of ancient, advanced civilizations. This would include analysis of ancient hieroglyphics, and measurement of magnetic fields around these sites. Hieroglyphics are a possible source of shape power artifacts or information.

9.3 Sonic Creation of Pyramid Forcefields

As discussed in section 7.2.4, a pyramid, as well as triangles based on pyramidal proportions, has a natural forcefield whether the pyramid is stationary or moving. In actuality, any stationary pyramid setting on the earth is moving at about 2000 miles per hour just due to the earth's rotation.

As discussed in chapter 7, a pyramid shape, when properly stimulated, intensifies the natural forcefield so that this forcefield becomes opaque to natural and man-made forces, such as magnetism, electromagnetism, (e.g., radio waves), and nuclear particles, and the opacity varies based on time of day, time of year, and position of the earth. In the experiments described in chapter 7, the forcefield was "fed" with an ion source.

Recent experiments by Joe Parr have enabled him to discover that the forcefield can also be fed and controlled by sonic energy (i.e. sound) of a specific frequency.

9.3.1 Acoustic Analysis of the King's Chamber

Joe did a sonic analysis of the King's chamber of the Great Pyramid. The analysis was done at the facilities of Sonatech, Inc., using modern, sophisticated, acoustic analysis computer programs. This is possible, since the exact measurements of the King's chamber, as well as all other metrics of the Great Pyramid, are well documented.

Using computer modeling, he found that the King's chamber resonated at 46.0, 92.0, 137.9, 183.9, and 229.9 hertz. This shows there are several resonant frequencies of the chamber. The only problem with this analysis is that the coffer on the floor of the King's Chamber changes the resonant properties of the chamber. What these frequencies do is bracket the range of analysis of the exact frequency (i.e., from 46.0 hertz to 239 hertz).

9.3.2 Finding the Pyramid Forcefield Frequency

To find the exact frequency, Joe stimulated the gravity wheel experiment with acoustic energy over the range defined above for an extended period. The acoustic energy stimulation was done over the range of analysis at very fine frequency increments. The reaction of the gravity wheel forcefields was measured.

The gravity wheel experiment slows down when the forcefield of the triangles becomes more opaque. By running the acoustic signal generator through the range of frequencies, Joe was able to pinpoint the

exact frequency at which the forcefields were intensified by the acoustic signal.

After detailed experimentation, Joe found the sonic resonant frequency to which the pyramid resonated. The frequency is 51.0 hertz!

For those who have studied the Great Pyramid, the base angle (i.e., the angle a side makes with the base) of the pyramid is 51.287 Degrees, which is also known as the Phi angle.

It is an astounding correlation that the number associated with the most celebrated angle of the Great Pyramid is also the resonant frequency of the pyramid's forcefield!

9.3.3 Interstellar Beacon

What the 51 hertz frequency does, when converted to an acoustic/sound signal, is intensify the opacity of the entire pyramidal forcefield. If the frequency is turned on and off, the forcefield turns on and off. When the forcefield turns off, then the energy in the forcefield collapses and initiates a pulse which is focused by the pyramid and the pulse travels down the energy conduit.

For the Egypt expedition, Joe has built a special signal generator with an attached audio amplifier driving a low frequency hi-fi speaker. The sound generation system is further stimulated with a special coded signal. This entire setup is designed to turn the Great Pyramid's forcefield on and off according to a specific signal train.

By turning the Great Pyramid's forcefield on and off, the energy in the forcefield, as it collapses, radiates out from the pyramid as a beam of energy which is not stopped by anything except another resonant field. The net result of turning the forcefield on and off is to cause the pyramid to act as an interstellar beacon or transmitter.

Joe has also built a digital controller which turns the frequency generator on and off. While we are all in the Great Pyramid, Joe will send a well known signal, pi (i.e., 3.1415), the ratio of a circle's circumference to its diameter, which is a universal constant, using the Great Pyramid as a transmitting antenna. Joe's interstellar transmitter will send 31415 over and over again for a 14-hour period during a predicted energy conduit from our sun. What we are doing in this stellar experiment is asking:

HELLO! IS ANYONE OUT THERE LISTENING?

Only one frequency, representing the longest wall of the King's chamber, has been deciphered. Two other dimensions remain unknown, along with their associated frequencies and functions.

Figure 9.3.3-1 depicts the Great Pyramid interstellar beacon experiment.

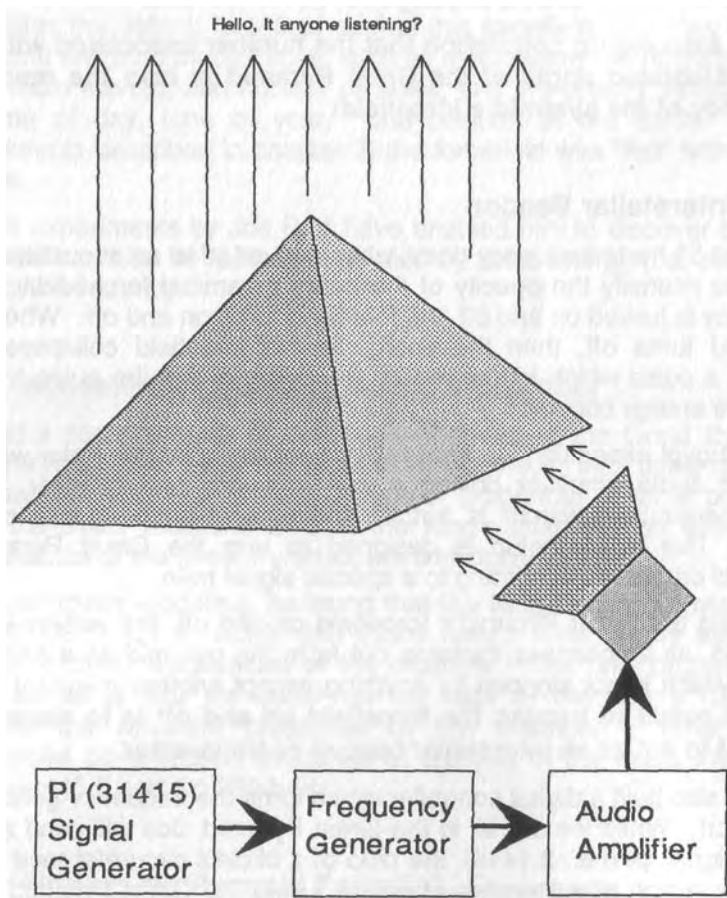

Figure 9.3.3-1 Great Pyramid Interstellar Beacon Experiment

9.4 Magnetic Field Measurements At the Great Pyramid

Another experiment, which I will be running, is to use a sensitive fluxgate magnetometer to measure the magnetic field orientation around the Great Pyramid and at other ancient sites. This will test for possible

distortion of the earth's magnetic field around these sites and may enable us to pinpoint possible buried metal artifacts.

9.1 Evidence for Advanced Technology in Ancient Egypt

The third aspect of the Egypt expedition is to look for indications of advanced technologies that the ancients may have had.

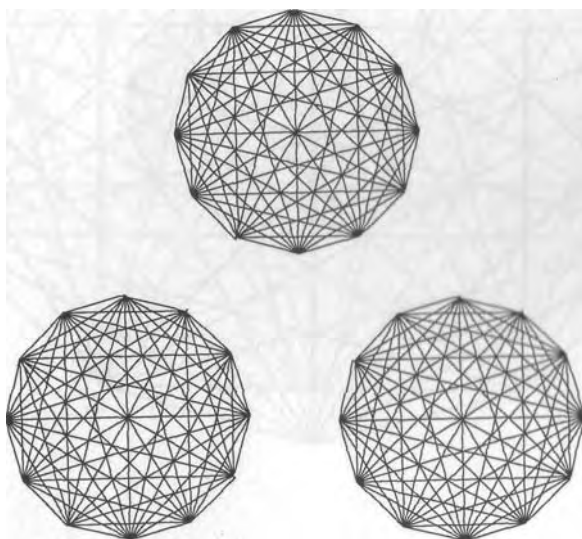

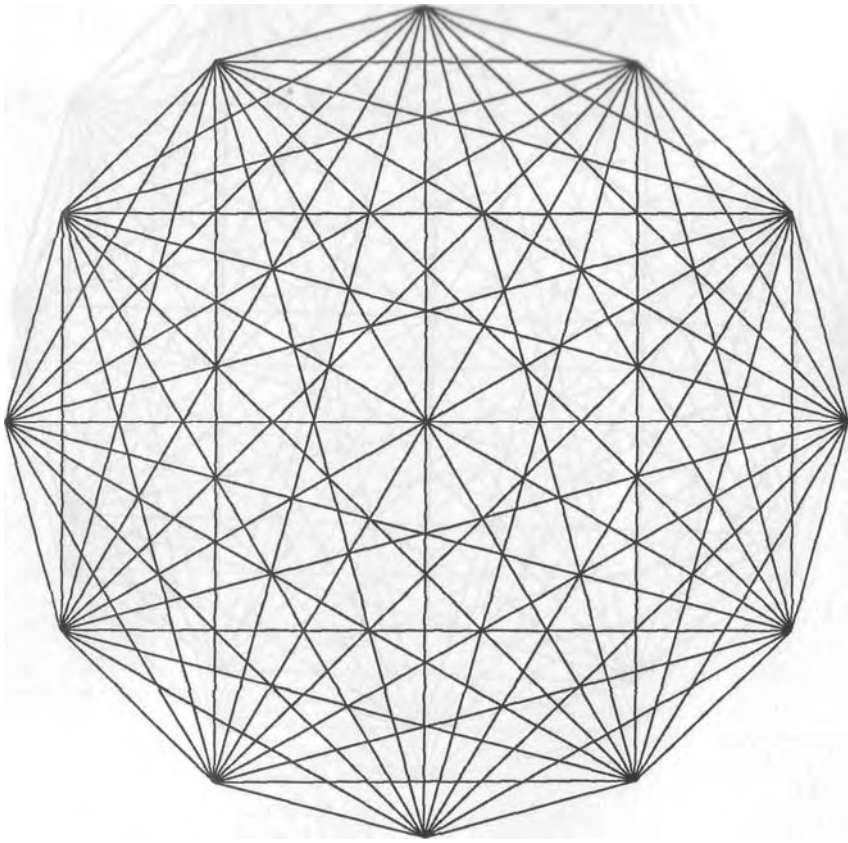

Appendix A.

Sacred Energy Movements

Introduction

In the summer of 1995, I decided that I needed to know more about how to personally manipulate aetheric energy. A few days later, in a very vivid spiritual experience, I found myself in an open area with three Beings. It was a beautiful place, green grass, a few nice trees, and peaceful, but with a feeling of great energies.

The Beings had very intense energy fields or auras, which I could both see and feel. Their auras radiated great power, strength, and control. The Beings were Masters or Adepts of aetheric energy who had first totally mastered themselves. The Master in charge showed me an energy movement to build up my own energy field like theirs.

I have had three more of these experiences since the first one in 1995, so there are a total of four movements, each designed for a specific purpose, but all under the general category of personal control and use of various aspects of universal energy.

During the first experience, the head man of the team imparted to me that there was an intense energy field close to the ground. I could sense/feel this energy above the surface of the ground, during the experience, and have since proved that I can also sense its level while awake. This energy field is green, 6-18 inches high, and flows in waves from south to north. The waves have tremendous amounts of energy.

General Directions

In doing the movements, the Masters stood, facing north, with palms together over chest in a prayerful pose. They were all in total control of themselves in mind body and spirit, and every bit the word Master

implies (i.e., one who has mastered oneself in all aspects). When doing the movements, you should get centered mentally, emotionally, and spiritually before proceeding with the movement. Each movement ends in the same position as starting; that is, in the prayerful pose facing north. Since the movements are designed to tap into natural energy fields for personal use, the movements are best done outdoors standing on the ground so as to be immersed as much as possible in the green energy. During cool weather, you can do the movements in the house standing on the ground floor. The effects of the movements are greatly diminished when not standing on the ground or the ground floor. Except for the Sweeps Movement, experiments have shown the maximum effects are when facing north.

In the following, the term "standard pose" means standing with feet pointed slightly out at shoulder width, facing north, with hands at chest height, held together in a prayerful pose, and centered mentally and spiritually.

These movements affect many levels of energy within the person from the spiritual through the aetheric, mental, emotional, and physical.

Cutter Movement

Begin with the standard pose. Then move the hands slightly apart keeping the palms facing. Start rotating the hands in a circular motion, all the time keeping them parallel and held as close to each other as possible without touching. With hands continuing rotating, squat down and bring arms down in front of your body to the ground level between your feet; and then stand back up, all the while doing the cutter motion, bringing the hands up over the top of the head. Be sure as you squat and then stand back up, to keep the rotating cutting motion going.

As you do this movement, visualize the energy being drawn into the four lower bodies and cleaning them out, especially the physical body's energy centers (i.e., the chakras and acupuncture points).

It has been found that the closer together you can keep the hands without them touching and close to the body during the Cutter Movement the more intense its effects.

The main effect of the movement is that it cleans up the four lower bodies (i.e., the physical, mental, emotional, and aetheric) of any negative energies. Experiments have shown the maximum effect of this movement is when facing north. We have named this movement "Cutter" after the motion of cutting up the negative energies in and around the four lower bodies.

Scoops Movement

Begin with the standard pose. Squat down and bring arms around in front of your body in an embracing motion. As you squat, make a scooping motion and scoop the green energy into your four lower bodies with hands cupped and arms moving in circular arcs toward the body, scooping in the energy. The word "bodies" is used to make you think and visualize the energy going into your mental, emotional, physical, and aetheric bodies. The initial scooping should be done with hands close to the ground doing several scoops, and maintain the scooping as you slowly stand up.

As the Masters stood up, they fluffed up their aura with a circular motion of moving the hands around in arcs bringing energy into the body. Also, they seemed to visualize the energy being drawn into the body. At the end, they flicked their hands, flicking off any negatively qualified energy they might have pulled out of their bodies.

The main effect of this movement is that it charges up the four lower bodies (i.e., the physical, mental, emotional, and aetheric). Experiments have shown the maximum effect of this movement is when facing north. We have named this movement "Scoops" after the motion of scooping the energy into the body.

After doing this movement, clairvoyants see the bodies filled with energy to such extent that it radiates for about 3 or 4 feet around the bodies in | brilliant very intense white light so bright that the physical body is hardly visible.

Snips Movement

Begin in the standard pose. This movement is performed by bringing together the fingers of the right hand in a snipping action. Again the person should be standing while doing this movement, with the left hand placed over the heart area. The right hand is extended in whatever direction the snipping is to occur and the fingers are extended and the fingers and thumb are brought together at the tips. The fingers are opened and closed in a snipping action. This movement shuts off negative energy projections from others, returns the energy to the sender, and cuts one free from any connections with others so you are not affected by the thoughts and pressures of energy from others. The best way to do the movement is to snip all around the body, front, back, sides, top, and bottom. When doing this movement, it sets up a blocking forcefield which protects the person. The activity of this movement was verified by clairvoyant and clairsentient tests. We have named this movement "Snips".

In a dream several months later, I was being attacked by a person with a gun. I did the Snips motion and the person was blasted back against a wall, while the gun was thrown from the person's hand. I was meant to show me the intense blocking and protection field put up by the Snips movement, even though it seems such an innocent motion.

Sweeps Movement

Begin in the standard pose. This movement is a wonderful movement to clear the aetheric and atmospheric location wherever it is directed. To start this movement, face north and extend the arms out in front, at chest height, with palms vertical and facing out away from the body. The left hand should be above the right hand on starting. Now visualize and feel energy going out from the palms of the hands and finger tips. Next, bring both hands down in a sweeping motion on the left side of the body and gently twist to the left at the waist during the sweep to the left. Now bring the arms back to the extended palms out position in front of the body; but this time the right hand is above the left hand. Then repeat the sweeping motion, but this time sweep to the right side of the body, all the while visualizing and feeling the energy blazing off the palms and finger tips. The next step is to rotate 45 degrees to the right and repeat the entire movement this time facing northeast. This sweeping motion to each side of the body is repeated in the eight major directions of the compass (i.e., north, northeast, east, southeast, south, southwest, west, northwest, and back to north).

Clairvoyant tests with this movement reveal that it sweeps out a path of dazzling light, totally clearing the area around where the person is located doing the movement. The movement also makes permanent records in the location and creates an intense focus of aetheric light energy there.

A Regime using Green Energy Movements

The above energy movements are described in the order in which one should do them. The following is a standard regime that should be done at least once a day.

Begin in the standard pose.

Cutter - Cleans out the four lower bodies so the other movements are more effective. Do this at least three times.

Scoops - Fills up the four lower bodies with huge amounts of energy. Do this at least three times.

Snips - Sets up a personal, protective, energy field and cuts one free of negative energy projections and connections with others. Do this around your whole body.

Sweeps - Clears the locality and the world of negative energy patterns, destructive aetheric records and establishes a focus of constructive energy. Do this in a complete circle twice.

Cutter - Do once or twice again to do more cleanup of the four lower bodies.

Scoops - Do twice again to really charge up the four lower bodies.

End in standard pose while giving gratitude to the Universe.

Results From The Four Energy Movements

We have found that if you are low on vitality, doing the Scoops movement will bring your energy level back up to dynamic levels. Because the green energy field is close to the earth, do the movement on a ground floor or outdoors. Face north, experiments have shown the Scoops works best in this direction.

Experiments show the Sweeps Movement is good for clearing a locality. Rooms, especially the workplace, where there seems to be low vitality or negative feelings, are cleared by doing the Sweeps movement. It is advisable to do the movement in the room when no one else is around as they may think you have flipped out. The extent of the area swept clear of undesirable patterns seems to be a function of the intent of the person doing the movement. If, while doing the sweeps, the energy off the hands is visualized going out for many miles then this actually occurs and a tremendous area is swept clear.

When doing these movements always walk the middle way and be mindful of others and do not intrude upon their way of life. We never have a right to impose our way of life on others. However, it is quite acceptable to be a blessing to the location, unobserved, wherever we are.

APPENDIX B

TRUNCATED TABLE OF NUCLIDE DATA

Information in this table supplied by
Torroidal Theorist - Charles Wm. Lucas, Jr., 4511 Poppe Place, Temple Hills, MD 20748 USA

This table is a selection of nuclides and the atomic structure based on the vortex model of the atom.

| ATOMIC SYMBOL | A | Z | P 1 | N 1 | P 2 | N 2 | P 3 | N 3 | P 4 | N 4 | P 5 | N 5 | P 6 | N 6 | P 7 | N 7 | P 8 | N 8 | ACTUAL SPIN | RING MODEL SPOIN | SHELL MODEL SPIN |
|---------------|----|---|-----|-----|-----|-----|-----|-----|-----|-----|-----|-----|-----|-----|-----|-----|-----|-----|-------------|------------------|------------------|
| n | 1 | 0 | 0 | 1 | | | | | | | | | | | | | | | 1/2 | 1/2 | 1/2 |
| H | 1 | 1 | 1 | 0 | | | | | | | | | | | | | | | 1/2 | 1/2 | 1/2 |
| H | 2 | 1 | 1 | 1 | | | | | | | | | | | | | | | 1 | 1 | 1 |
| H | 3 | 1 | 1 | 2 | | | | | | | | | | | | | | | 1/2 | 1/2 | 1/2 |
| He | 3 | 2 | 2 | 1 | | | | | | | | | | | | | | | 1/2 | 1/2 | 1/2 |
| He | 4 | 2 | 2 | 2 | | | | | | | | | | | | | | | 0 | 0 | 0 |
| Li | 5 | 3 | | 2 | 3 | | | | | | | | | | | | | | 3/2 | 3/2 | 3/2 |
| Li | 6 | 3 | 2 | 2 | 1 | 1 | | | | | | | | | | | | | 1 | 1 | 3 |
| Li | 7 | 3 | | | 3 | 4 | | | | | | | | | | | | | 3/2 | 3/2 | 3/2 |
| Li | 8 | 3 | | 1 | 3 | 4 | | | | | | | | | | | | | 2 | 2 | 2 |
| Li | 9 | 3 | | 2 | 3 | 4 | | | | | | | | | | | | | 3/2 | 3/2 | 3/2 |
| Li | 11 | 3 | 1 | | 2 | | | 8 | | | | | | | | | | | 1/2 | 1/2 | 3/2 |
| Be | 6 | 4 | 2 | 2 | 2 | | | | | | | | | | | | | | 0 | 0 | 0 |
| Be | 7 | 4 | 2 | | 2 | 3 | | | | | | | | | | | | | 3/2 | 3/2 | 3/2 |
| B | 7 | 5 | 2 | 2 | 3 | | | | | | | | | | | | | | ? | 3/2 | 1/2 |
| B | 8 | 5 | 2 | 2 | 3 | 1 | | | | | | | | | | | | | 2 | 2 | 2 |

| ATOMIC SYMBOL | A | Z | P 1 | N 1 | P 2 | N 2 | P 3 | N 3 | P 4 | N 4 | P 5 | N 5 | P 6 | N 6 | P 7 | N 7 | P 8 | N 8 | ACTUAL SPIN | RING MODEL SPOIN | SHELL MODEL SPIN |
|---------------|----|----|-----|-----|-----|-----|-----|-----|-----|-----|-----|-----|-----|-----|-----|-----|-----|-----|-------------|------------------|------------------|
| C | 8 | 6 | 2 | | 4 | 2 | | | | | | | | | | | | | 0 | 0 | 0 |
| C | 9 | 6 | 2 | | 4 | 3 | | | | | | | | | | | | | 3/2 | 3/2 | 3/2 |
| N | 12 | 7 | 1 | 1 | 6 | 4 | | | | | | | | | | | | | 1 | 1 | 2 |
| N | 13 | 7 | 1 | | 6 | 6 | | | | | | | | | | | | | (1/2) | 1/2 | 1/2 |
| O | 12 | 8 | | | | | | | | | | | | | | | | | ? | 0 | 0 |
| O | 13 | 8 | | | 4 | 3 | 4 | 4 | | | | | | | | | | | 3/2 | 3/2 | 3/2 |
| F | 15 | 9 | 1 | 2 | 6 | 6 | | | | | | | | | | | | | (1/2) | 1/2 | 5/2 |
| F | 16 | 9 | | 1 | 1 | 2 | 6 | 6 | | | | | | | | | | | 0 | 0 | 3 |
| Ne | 16 | 10 | 2 | | 8 | 6 | | | | | | | | | | | | | ? | 0 | 0 |
| Ne | 17 | 10 | 2 | 1 | 8 | 6 | | | | | | | | | | | | | 1/2 | 1/2 | 1/2 |
| Na | 19 | 11 | | | 3 | | 8 | 8 | | | | | | | | | | | ? | 3/2 | 5/2 |
| Na | 20 | 11 | | | 3 | 1 | 8 | 8 | | | | | | | | | | | 2 | 2 | 5 |
| Mg | 20 | 12 | | | | | | | | | | | | | | | | | ? | 0 | 0 |
| Mg | 21 | 12 | | 4 | 4 | 5 | 8 | | | | | | | | | | | | 5/2 | 5/2 | 5/2 |
| Al | 22 | 13 | | | 5 | 3 | 8 | 6 | | | | | | | | | | | 4 | 4 | 5 |
| Al | 23 | 13 | | | 5 | 4 | 8 | 6 | | | | | | | | | | | ? | 5/2 | 5/2 |
| Si | 23 | 14 | 2 | | 4 | 3 | 8 | 6 | | | | | | | | | | | ? | 3/2 | 5/2 |
| Si | 24 | 14 | 2 | | 4 | 4 | 8 | 6 | | | | | | | | | | | ? | 0 | 0 |
| P | 26 | 15 | 2 | 1 | 5 | 4 | 8 | 6 | | | | | | | | | | | 3 | 3 | 3 |
| P | 27 | 15 | 1 | 0 | 6 | 4 | 8 | 8 | | | | | | | | | | | 1/2 | 1/2 | 1/2 |
| S | 29 | 16 | 2 | 0 | 6 | 5 | 8 | 8 | | | | | | | | | | | 5/2 | 5/2 | 5/2 |
| S | 30 | 16 | 2 | 0 | | | | | 14 | 14 | | | | | | | | | 0 | 0 | 0 |
| Cl | 31 | 17 | | | 3 | 0 | | | 14 | 14 | | | | | | | | | 3/2 | 3/2 | 3/2 |
| Cl | 32 | 17 | 1 | 1 | 2 | 0 | | | 14 | 14 | | | | | | | | | 1 | 1 | 2 |

| ATOMIC SYMBOL | A | Z | P 1 | N 1 | P 2 | N 2 | P 3 | N 3 | P 4 | N 4 | P 5 | N 5 | P 6 | N 6 | P 7 | N 7 | P 8 | N 8 | ACTUAL SPIN | RING MODEL SPOIN | SHELL MODEL SPIN |
|---------------|----|----|-----|-----|-----|-----|-----|-----|-----|-----|-----|-----|-----|-----|-----|-----|-----|-----|-------------|------------------|------------------|
| Ar | 31 | 18 | | | | | | | | | | | | | | | | | ? | | 5/2 |
| Ar | 32 | 18 | | | 2 | | | | 16 | 14 | | | | | | | | | ? | 0 | 0 |
| K | 35 | 19 | | | 3 | 2 | | | 16 | 14 | | | | | | | | | 3/2 | 3/2 | 3/2 |
| K | 36 | 19 | | | 3 | 1 | | | 16 | 16 | | | | | | | | | 2 | 2 | 3 |
| Ca | 35 | 20 | | 1 | 6 | | | | 14 | 14 | | | | | | | | | ? | 1/2 | 1/2 |
| Ca | 36 | 20 | 2 | | 4 | 2 | | | 14 | 14 | | | | | | | | | ? | 0 | 0 |
| Sc | 40 | 21 | 2 | 2 | 5 | 3 | | | 14 | 14 | | | | | | | | | 4 | 4 | 5 |
| Sc | 41 | 21 | | | 7 | 6 | | | 14 | 14 | | | | | | | | | 7/2 | 7/2 | 7/2 |
| Ti | 41 | 22 | | | 2 | 3 | 8 | | 14 | 14 | | | | | | | | | 3/2 | 3/2 | 3/2 |
| Ti | 42 | 22 | | | 2 | 4 | 8 | | 14 | 14 | | | | | | | | | ? | 0 | 0 |
| V | 43 | 23 | | | | | | | | | | | | | | | | | ? | | 7/2 |
| V | 44 | 23 | | | | | | | | | | | | | | | | | ? | | 7 |
| Cr | 44 | 24 | 2 | 2 | 6 | 6 | | | 14 | 14 | | | | | | | | | ? | 0 | 0 |
| Cr | 45 | 24 | 2 | 2 | 6 | 7 | | | 14 | 14 | | | | | | | | | 7/2 | 7/2 | 7/2 |
| Mn | 46 | 25 | | | | | | | | | | | | | | | | | ? | | 7 |
| Mn | 47 | 25 | | | | | | | | | | | | | | | | | ? | | 7/2 |
| Fe | 48 | 26 | | | | | | | | | | | | | | | | | ? | 0 | 0 |
| Fe | 49 | 26 | | | | | | | | | | | | | | | | | 7/2 | | 7/2 |
| Co | 56 | 27 | | | 3 | 5 | 6 | 6 | 18 | 18 | | | | | | | | | 4 | 4 | 5 |
| Co | 57 | 27 | | | 2 | 4 | 7 | 8 | 18 | 18 | | | | | | | | | 7/2 | 7/2 | 7/2 |
| Ni | 58 | 28 | | | 2 | 2 | | | | | | | 26 | 28 | | | | | (0) | 0 | 0 |
| Ni | 60 | 28 | | | 2 | 4 | | | | | | | 26 | 28 | | | | | (0) | 0 | 0 |
| Cu | 60 | 29 | | | 1 | 3 | | | | | | | 28 | 28 | | | | | 2 | 2 | 7 |
| Cu | 63 | 29 | | 2 | 3 | 4 | | | | | | | 26 | 28 | | | | | 3/2 | 3/2 | 3/2 |

| ATOMIC SYMBOL | A | Z | P 1 | N 1 | P 2 | N 2 | P 3 | N 3 | P 4 | N 4 | P 5 | N 5 | P 6 | N 6 | P 7 | N 7 | P 8 | N 8 | ACTUAL SPIN | RING MODEL SPOIN | SHELL MODEL SPIN |
|---------------|----|----|-----|-----|-----|-----|-----|-----|-----|-----|-----|-----|-----|-----|-----|-----|-----|-----|-------------|------------------|------------------|
| Zn | 64 | 30 | | | 4 | 4 | | | | | | | 26 | 30 | | | | | (0) | 0 | 0 |
| Zn | 66 | 30 | | | 4 | 6 | | | | | | | 26 | 30 | | | | | (0) | 0 | 0 |
| Ga | 68 | 31 | 1 | 1 | 4 | 6 | | | | | | | 26 | 30 | | | | | 1 | 1 | 4 |
| Ga | 69 | 31 | 2 | 2 | 3 | 4 | | | | | | | 26 | 32 | | | | | 3/2 | 3/2 | 3/2 |
| Ge | 70 | 32 | | | 4 | 6 | | | | | | | 28 | 32 | | | | | 0 | 0 | 0 |
| Ge | 72 | 32 | | 2 | 4 | 6 | | | | | | | 28 | 32 | | | | | 0 | 0 | 0 |
| As | 73 | 33 | | | 3 | 4 | 4 | 6 | | | | | 26 | 30 | | | | | 3/2 | 3/2 | 5/2 |
| As | 74 | 33 | | | 1 | 3 | 6 | 8 | | | | | 26 | 30 | | | | | (2) | 2 | 7 |
| Se | 73 | 34 | | | | | | | 8 | 9 | | | 26 | 30 | | | | | (9/2) | 9/2 | 1/2 |
| Se | 74 | 34 | | | | | | | 8 | 10 | | | 26 | 30 | | | | | (0) | 0 | 0 |
| Br | 77 | 35 | | | 3 | 4 | 6 | 8 | | | | | 26 | 30 | | | | | 3/2 | 3/2 | 5/2 |
| Br | 79 | 35 | | | 3 | 4 | 6 | 8 | | | | | 26 | 32 | | | | | 3/2 | 3/2 | 5/2 |
| Kr | 78 | 36 | | | 2 | 4 | 6 | 8 | | | | | 28 | 30 | | | | | (0) | 0 | 0 |
| Kr | 80 | 36 | | | 2 | 4 | 6 | 8 | | | | | 28 | 32 | | | | | (0) | 0 | 0 |
| Rb | 81 | 37 | | | 3 | 4 | 8 | 8 | | | | | 26 | 32 | | | | | 3/2 | 3/2 | 5/2 |
| Rb | 85 | 37 | | 2 | 5 | 6 | 6 | 8 | | | | | 26 | 32 | | | | | 5/2 | 5/2 | 5/2 |
| Sr | 84 | 38 | | | 2 | 4 | | | 8 | 10 | | | 28 | 32 | | | | | (0) | 0 | 0 |
| Sr | 86 | 38 | | 2 | | | | | 10 | 14 | | | 28 | 32 | | | | | (0) | 0 | 0 |
| Y | 88 | 39 | | 2 | 3 | 5 | | | 8 | 10 | | | 28 | 32 | | | | | (4) | 4 | 5 |
| Y | 89 | 39 | 1 | 2 | 4 | 6 | | | 8 | 10 | | | 26 | 32 | | | | | 1/2 | 1/2 | 1/2 |
| Zr | 90 | 40 | | | 4 | 6 | | | 8 | 12 | | | 28 | 32 | | | | | 0 | 0 | 0 |
| Zr | 91 | 40 | | 2 | 4 | 5 | | | 8 | 12 | | | 28 | 32 | | | | | 5/2 | 5/2 | 7/2 |
| Nb | 93 | 41 | 2 | 2 | | | | 8 | 9 | 10 | | | 30 | 32 | | | | | 9/2 | 9/2 | 9/2 |
| Mo | 92 | 42 | | | | | | | 14 | 18 | | | 28 | 32 | | | | | (0) | 0 | 0 |
| Mo | 94 | 42 | | | | | | 8 | 12 | 14 | | | 30 | 32 | | | | | (0) | 0 | 0 |

| ATOMIC SYMBOL | A | Z | P 1 | N 1 | P 2 | N 2 | P 3 | N 3 | P 4 | N 4 | P 5 | N 5 | P 6 | N 6 | P 7 | N 7 | P 8 | N 8 | ACTUAL SPIN | RING MODEL SPOIN | SHELL MODEL SPIN |
|---------------|-----|----|-----|-----|-----|-----|-----|-----|-----|-----|-----|-----|-----|-----|-----|-----|-----|-----|-------------|------------------|------------------|
| Tc | 99 | 43 | | | 4 | 6 | | 8 | 9 | 10 | | | 30 | 32 | | | | | 9/2 | 9/2 | 9/2 |
| Ru | 96 | 44 | | | | | | 8 | 12 | 14 | | | 32 | 32 | | | | | (0) | 0 | 0 |
| Ru | 98 | 44 | | 2 | | | | 8 | 12 | 14 | | | 32 | 32 | | | | | (0) | 0 | 0 |
| Pd | 102 | 46 | | | | | | 8 | | | | | | | 46 | 48 | | | (0) | 0 | 0 |
| Pd | 104 | 46 | | 2 | | | | 8 | | | | | | | 46 | 48 | | | (0) | 0 | 0 |
| Ag | 107 | 47 | 1 | 2 | | | | 8 | | | | | | | 46 | 50 | | | 1/2 | 1/2 | 9/2 |
| Ag | 109 | 47 | 1 | 2 | | 4 | | 6 | | | | | | | 46 | 50 | | | 1/2 | 1/2 | 9/2 |
| Cd | 106 | 48 | | | | | | 8 | | | | | | | 48 | 50 | | | (0) | 0 | 0 |
| Cd | 108 | 48 | | 2 | | | | 8 | | | | | | | 48 | 50 | | | (0) | 0 | 0 |
| In | 113 | 49 | | | | | 8 | 8 | 9 | 10 | | 14 | 32 | 32 | | | | | 9/2 | 9/2 | 9/2 |
| In | 114 | 49 | | 1 | | | 8 | 8 | 9 | 10 | | 14 | 32 | 32 | | | | | 5 | 5 | 6 |
| Sn | 112 | 50 | | | | | | | | 12 | | | | | 50 | 50 | | | (0) | 0 | 0 |
| Sn | 114 | 50 | | | | | | | | 14 | | | | | 50 | 50 | | | (0) | 0 | 0 |
| Sb | 121 | 51 | | | 5 | 6 | | | | 18 | | | | | 46 | 48 | | | 5/2 | 5/2 | 7/2 |
| Sb | 122 | 51 | | | 1 | 3 | | | | 18 | | | | | 50 | 50 | | | 2 | 2 | 9 |
| Te | 120 | 52 | 2 | 2 | | | | | | 16 | | | | | 50 | 50 | | | (0) | 0 | 0 |
| Te | 122 | 52 | 2 | 2 | | | | | | 18 | | | | | 50 | 50 | | | (0) | 0 | 0 |
| I | 126 | 53 | 2 | 2 | 1 | 3 | | | | 18 | | | | | 50 | 50 | | | 2 | 2 | 9 |
| I | 127 | 53 | | | 5 | 6 | | | | 18 | | | | | 48 | 50 | | | 5/2 | 5/2 | 7/2 |
| Xe | 124 | 54 | | | 4 | 6 | | | | 14 | | | | | 50 | 50 | | | (0) | 0 | 0 |
| Xe | 126 | 54 | | | 4 | 6 | | | | 16 | | | | | 50 | 50 | | | (0) | 0 | 0 |
| Cs | 131 | 55 | | 2 | 5 | 6 | | | | 18 | | | | | 50 | 50 | | | 5/2 | 5/2 | 11/2 |
| Cs | 133 | 55 | | 2 | 7 | 8 | | | | 18 | | | | | 48 | 50 | | | 7/2 | 7/2 | 11/2 |
| Ba | 129 | 56 | | 1 | 6 | 8 | | | | 14 | | | | | 50 | 50 | | | (1/2) | 1/2 | 11/2 |
| Ba | 130 | 56 | | | 6 | 8 | | | | 16 | | | | | 50 | 50 | | | (0) | 0 | 0 |

| ATOMIC SYMBOL | A | Z | P 1 | N 1 | P 2 | N 2 | P 3 | N 3 | P 4 | N 4 | P 5 | N 5 | P 6 | N 6 | P 7 | N 7 | P 8 | N 8 | ACTUAL SPIN | RING MODEL SPOIN | SHELL MODEL SPIN |
|---------------|-----|----|-----|-----|-----|-----|-----|-----|-----|-----|-----|-----|-----|-----|-----|-----|-----|-----|-------------|------------------|------------------|
| La | 138 | 57 | 2 | 2 | 5 | 5 | | 8 | | 16 | | | | | 50 | 50 | | | 5 | 5 | 9 |
| La | 139 | 57 | | | 7 | 8 | | 8 | | 16 | | | | | 50 | 50 | | | 7/2 | 7/2 | 7/2 |
| Ce | 138 | 58 | 2 | 2 | 6 | 6 | | 8 | | 14 | | | | | 50 | 50 | | | (0) | 0 | 0 |
| Ce | 139 | 58 | | 2 | 2 | 3 | 6 | 8 | | 18 | | | | | 50 | 50 | | | 3/2 | 3/2 | 11/2 |
| Pr | 141 | 59 | | 2 | 4 | 4 | 5 | 8 | | 18 | | | | | 50 | 50 | | | 5/2 | 5/2 | 5/2 |
| Nd | 141 | 60 | | 2 | 2 | 3 | 8 | 8 | | 18 | | | | | 50 | 50 | | | (3/2) | 3/2 | 11/2 |
| Nd | 142 | 60 | | 2 | 2 | 4 | 8 | 8 | | 18 | | | | | 50 | 50 | | | (0) | 0 | 0 |
| Pm | 147 | 61 | | 2 | 6 | 8 | 7 | 8 | | | | 18 | | | 48 | 50 | | | (7/2) | 7/2 | 5/2 |
| Sm | 144 | 62 | | | | | | | 12 | 14 | | 18 | | | 50 | 50 | | | (0) | 0 | 0 |
| Sm | 147 | 62 | | 2 | 6 | 7 | 8 | 8 | | | | 18 | | | 48 | 50 | | | 7/2 | 7/2 | 9/2 |
| Gd | 154 | 64 | | | | | | 8 | 14 | 14 | | 18 | | | 50 | 50 | | | (0) | 0 | 0 |
| Gd | 155 | 64 | | | 2 | 3 | | | 14 | 18 | | 18 | | | 48 | 50 | | | 3/2 | 3/2 | 9/2 |
| Dy | 160 | 66 | | | | 8 | | | 16 | 18 | | 18 | | | 50 | 50 | | | (0) | 0 | 0 |
| Dy | 162 | 66 | | 2 | | 8 | | | 16 | 18 | | 18 | | | 50 | 50 | | | (0) | 0 | 0 |
| Ho | 165 | 67 | | 2 | 7 | 8 | | 8 | 10 | 12 | | 18 | | | 50 | 50 | | | 7/2 | 7/2 | 7/2 |
| Er | 164 | 68 | | 2 | | 8 | | | 18 | 18 | | 18 | | | 50 | 50 | | | (0) | 0 | 0 |
| Er | 166 | 68 | | | | | | | 18 | 18 | | | | 32 | 50 | 50 | | | (0) | 0 | 0 |
| Yb | 172 | 70 | 2 | 2 | | | | | 18 | 18 | | | | 32 | 50 | 50 | | | (0) | 0 | 0 |
| Yb | 174 | 70 | | | 2 | 4 | | | 18 | 18 | | | | 32 | 50 | 50 | | | (0) | 0 | 0 |
| Lu | 176 | 71 | | | 5 | 7 | | | 16 | 16 | | | | 32 | 50 | 50 | | | (6?) | 6 | 8 |
| Hf | 176 | 72 | | | 4 | 4 | | | 18 | 18 | | | | 32 | 50 | 50 | | | (0) | 0 | 0 |
| Hf | 178 | 72 | | | 4 | 6 | | | 18 | 18 | | | | 32 | 50 | 50 | | | (0) | 0 | 0 |
| Ta | 181 | 73 | | | 7 | 8 | | | 16 | 18 | | | | 32 | 50 | 50 | | | 7/2 | 7/2 | 11/2 |
| W | 180 | 74 | | | 6 | 6 | | | 18 | 18 | | | | 32 | 50 | 50 | | | 0 | 0 | 0 |
| W | 182 | 74 | | | | | | | | | 24 | 26 | | 32 | 50 | 50 | | | 0 | 0 | 0 |

| ATOMIC SYMBOL | A | Z | P 1 | N 1 | P 2 | N 2 | P 3 | N 3 | P 4 | N 4 | P 5 | N 5 | P 6 | N 6 | P 7 | N 7 | P 8 | N 8 | ACTUAL SPIN | RING MODEL SPOIN | SHELL MODEL SPIN |
|---------------|-----|----|-----|-----|-----|-----|-----|-----|-----|-----|-----|-----|-----|-----|-----|-----|-----|-----|-------------|------------------|------------------|
| Re | 187 | 75 | | | 5 | 6 | | | | | 20 | 24 | | 32 | 50 | 50 | | | 5/2 | 5/2 | 11/2 |
| Os | 186 | 76 | | | | | | | | | 26 | 28 | | 32 | 50 | 50 | | | (0) | 0 | 0 |
| Os | 187 | 76 | | 1 | | | | | | | 26 | 28 | | 32 | 50 | 50 | | | 1/2 | 1/2 | 1/2 |
| Ir | 191 | 77 | | | 3 | 4 | | | | | 24 | 28 | | 32 | 50 | 50 | | | 3/2 | 3/2 | 11/2 |
| Ir | 193 | 77 | | 2 | 3 | | | | | | 24 | 28 | | 32 | 50 | 50 | | | 3/2 | 3/2 | 11/2 |
| Pt | 192 | 78 | | | | | | | | | 28 | 32 | | 32 | 50 | 50 | | | (0) | 0 | 0 |
| Pt | 194 | 78 | | 2 | | | | | | | 28 | 32 | | 32 | 50 | 50 | | | (0) | 0 | 0 |
| Au | 196 | 79 | | | 1 | 3 | | | | | 28 | 32 | | 32 | 50 | 50 | | | 2 | 2 | 12 |
| Au | 197 | 79 | | 2 | 3 | 4 | | | | | 26 | 30 | | 32 | 50 | 50 | | | 3/2 | 3/2 | 11/2 |
| Hg | 196 | 80 | | | | | | | | 18 | | 18 | 30 | 30 | 50 | 50 | | | (0) | 0 | 0 |
| Hg | 198 | 80 | | | | | | | | 18 | | 18 | 30 | 32 | 50 | 50 | | | (0) | 0 | 0 |
| Tl | 200 | 81 | | | 1 | 3 | | | | 18 | | 18 | 30 | 30 | 50 | 50 | | | 2 | 2 | 12 |
| Tl | 203 | 81 | 1 | 2 | | 8 | | | | | 30 | 30 | | 32 | 50 | 50 | | | 1/2 | 1/2 | 11/2 |
| Pb | 204 | 82 | | | | 8 | | | | 14 | | 18 | 32 | 32 | 50 | 50 | | | (0) | 0 | 0 |
| Pb | 205 | 82 | | | | 5 | | | | 18 | | 18 | 32 | 32 | | | 50 | 50 | (5/2) | 5/2 | 13/2 |
| Bi | 208 | 83 | | | 1 | 7 | | | | 18 | | 18 | 32 | 32 | | | 50 | 50 | (4) | 4 | 11 |
| Bi | 209 | 83 | | 1 | 1 | 7 | | | | 18 | | 18 | 32 | 32 | | | 50 | 50 | 9/2 | 9/2 | 9/2 |
| Po | 209 | 84 | | 1 | 2 | 6 | | | | 18 | | 18 | 32 | 32 | | | 50 | 50 | 1/2 | 1/2 | 13/2 |
| Ac | 227 | 89 | | 2 | 3 | 8 | | | | | | 18 | | 32 | 32 | 32 | 50 | 50 | 3/2 | 3/2 | 9/2 |
| Th | 229 | 90 | | | 4 | 5 | | 6 | | | | 18 | | 32 | 32 | 32 | 50 | 50 | (5/2) | 5/2 | 11/2 |
| Th | 230 | 90 | | | 4 | 6 | | 6 | | | | 18 | | 32 | 32 | 32 | 50 | 50 | (0) | 0 | 0 |
| Pa | 231 | 91 | 2 | 2 | 3 | 4 | | 6 | | | | 18 | | 32 | 32 | 32 | 50 | 50 | 3/2 | 3/2 | 9/2 |
| Pa | 237 | 91 | 2 | 2 | 3 | 6 | | 8 | | | | 18 | | 32 | 32 | 32 | 50 | 50 | (3/2) | 3/2 | 9/2 |
| U | 233 | 92 | 2 | 2 | 4 | 5 | | 6 | | | | 18 | | 32 | 32 | 32 | 50 | 50 | 5/2 | 5/2 | 11/2 |
| U | 235 | 92 | | | 6 | 7 | | 8 | | | | 18 | | 32 | 32 | 32 | 50 | 50 | 7/2 | 7/2 | 11/2 |

| ATOMIC SYMBOL | A | Z | P 1 | N 1 | P 2 | N 2 | P 3 | N 3 | P 4 | N 4 | P 5 | N 5 | P 6 | N 6 | P 7 | N 7 | P 8 | N 8 | ACTUAL SPIN | RING MODEL SPOIN | SHELL MODEL SPIN |
|---------------|-----|----|-----|-----|-----|-----|-----|-----|-----|-----|-----|-----|-----|-----|-----|-----|-----|-----|-------------|------------------|------------------|
| Np | 237 | 93 | 2 | 2 | 5 | 6 | | 8 | | | | 18 | | 32 | 32 | 32 | 50 | 50 | 5/2 | 5/2 | 7/2 |
| Np | 239 | 93 | 1 | 2 | 6 | 8 | | 8 | | | | 18 | | 32 | 32 | 32 | 50 | 50 | 1/2 | 1/2 | 7/2 |
| Pu | 239 | 94 | | 1 | 8 | 8 | | 8 | | | | 18 | | 32 | 32 | 32 | 50 | 50 | 1/2 | 1/2 | 11/2 |
| Pu | 241 | 94 | 2 | 2 | 4 | 5 | | | | 12 | | 18 | | 32 | 32 | 32 | 50 | 50 | 5/2 | 5/2 | 11/2 |
| Am | 241 | 95 | 2 | 2 | 5 | 6 | | | | 10 | | 18 | | 32 | 32 | 32 | 50 | 50 | 5/2 | 5/2 | 7/2 |
| Am | 242 | 95 | 1 | 1 | 6 | 8 | | | | 10 | | 18 | | 32 | 32 | 32 | 50 | 50 | 1 | 1 | 9 |
| Cm | 242 | 96 | 2 | 2 | 6 | 6 | | | | 10 | | 18 | | 32 | 32 | 32 | 50 | 50 | (0) | 0 | 0 |
| Bk | 250 | 97 | | | 1 | 3 | 8 | 8 | | 16 | | 18 | | 32 | 32 | 32 | 50 | 50 | (2) | 2 | 7 |