

# The OTC-X1

While most observers regard Mr. Carr's inventions as great miracles of ingenuity, their greatest asset is the fact that they are miracles of simplicity.

In looking to a nature for his guidance, as he was first inspired to do by the oracles of Sir Francis Bacon, Otis T. Carr observed while still a very young man, that natural systems though they may appear complex, are never complicated.

The forms and movements of universal bodies are geometrically precise---their movements constant and orderly.

The motions and directions of universal energies are ever predictable in dimension, frequency, and velocity.

So after he had learned enough of these basics, in about 1938, Mr. Carr began to design his Spaceforms as miniature reproductions of natural, universal systems.

As you look at the electro-gravitational power-package of the OTC-X1, in the phantom view on this page for example, wherein all the essential components are shown within the hull environment, you will see what is in effect a miniature solar-system.

Let us say by analogy, that the Utron electrical accumulator in the center is the Sun of this system. Within its physical material walls of curvilinear dissimilars there pulsates an electrochemical heart of a billion-billion atomic and subatomic hatcheries that are its inertial energy potential. Each a translation of nature's universal miracles, each of complex simplicity, and each ever ready to supply a part of the pressure energy that will take the OTC-X1 wherever man chooses to travel throughout God's vast Universe.

From this heart system, within the Utron, electromotive forces are conducted to the copper-wire coils of the planetary field-magnets, which you see twelve of in this drawing, spaced equidistant from each other integrally around the periphery of the lower hull-section.

The excitation of forces between the pole faces of the magnets establishes a condition of uni-polarization between the magnets and the capacitor plates, which you see formed around the structural insulator of the central disc-assembly.

The consequent pressure energy of these uni-polarized space-forces gives an equal and opposite push against the two opposing assemblies (one being the hull, the other the center disc) and causes them to rotate counter to each other with equal velocity. As soon as this motion starts, the Utron regenerative-armature coils, of which you see six in this drawing, mounted on trunnion shafts through their opposing vortexial axes, immediately begin to complete the cycle of mutation and transmutation of matter and energy by which the forces that first emanated from the central accumulator are returned to their relatively static inertial balance.

So in both appearance and function, our OTC-X1 Spacecraft is a miniature facsimile of the planets, the moons, the stars, and the energies in the unified field of the natural systems around us.

By obeying instead of violating the Universal natural laws under which our systems operate, we are able to regulate the course and relative velocity of our craft in its travels either from one terrestrial city to another, or out on lengthy visits into the unexplored reaches of the great beyond.

For it is true of universal space as it is true of our own ocean waters, that the immutable laws of mass-displacement will let our OTC Spacecraft ride the magneto-gravitic waves--as buoyant as the liners ride the Atlantic.

And even more so.

Electrical flight in the OTC-X1 Spacecraft will transcend all of man's prior experiences with the transportation devices of our time in many ways other than relate to speed, velocity, and distance.

While it is true that we will soon learn to regard a million earth-miles-an-hour as an interplanetary snail's pace, we will also learn that man need experience no annoyance or discomfort either in or out of this earth's atmosphere.

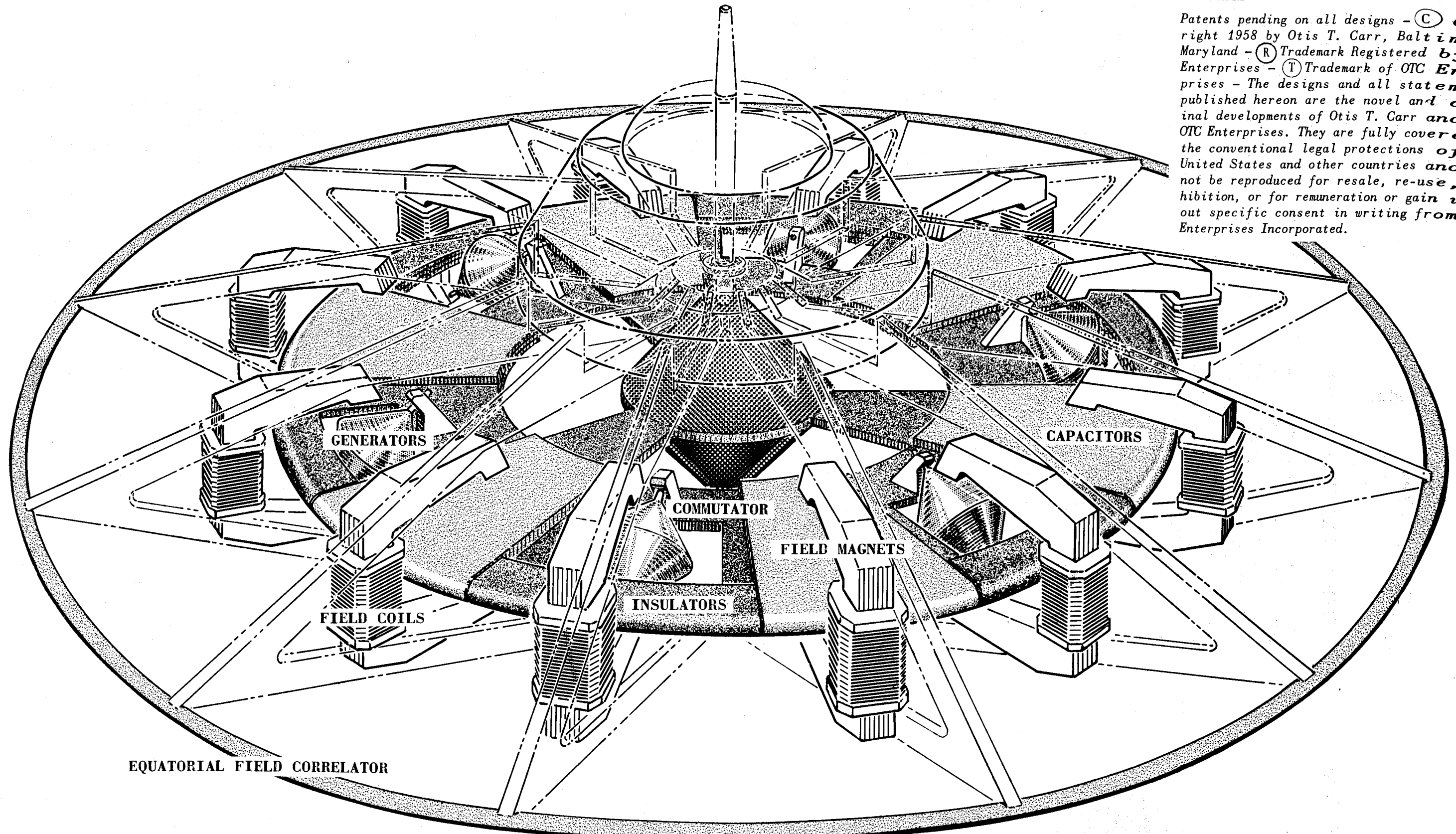

EQUATORIAL FIELD CORRELATOR

As your eyes take in the shapes and relationships in these illustrations of the miniature model you're about to build, your reasoning will let you understand much about the invisible forces that contribute to the noise-free, pressure-free, and vibrationless sensation of floating flight to be experienced in the passenger living-rooms aboard the OTC-X1. It will be very much like reclining in an overstuffed armchair on our comfortable old planet earth.

Its mechanical behavior being like that of a giant gyroscope, and electrically like a planet with its own atmosphere and force-field, the OTC-X1 will know nothing of sound barriers, shock-waves, skin friction, turbulence, or "G-strains."

Neither will it or its occupants need fear any harm from cosmic forces, Gamma-rays, X-rays, or other radiation, because the OTC-X1 craft will be either using or absorbing all such forces, or by the pressure and polarity of its own force field, be shielded against their penetration.

While the commutation system for the actual energized flight-model craft is not shown together with the other components on this sheet\*, its design for the circuitry of electro-gravitational forces permits an environmental surroumdment of equal and opposite pressures in and from all directions, whose circumference is nowhere and whose center is everywhere relative to the universal field.

Thus, by imitating nature, we become one with nature--by translating her shapes and duplicating her motions we join forces with natural energies and become magnificently independent of man-made limitations, man-constructed barriers, man-invented fears, and man-imposed controls!

And with the flick of a switch, at speeds too dazzling for

human observation, we can with hair-line precision alter our course in any desired direction by interposing artificial variable resistances among the natural forces of pressure in differential relationships to the tensor-stress constants within any system of the universal force-field.

This then, is the route past all limits of horizons, a breakthrough that brushes aside all artificial obstruction in any form.

It is as predicted in Bacon's prefatory remark several hundred years ago when he published his *Novum Organum*,

*"If man would conquer Nature  
Man must join with Nature."*

The inventions of Otis T. Carr, and their development for the world's free commerce and industry by the OTC Enterprises, mark man's attainment of the ultimate employment of Nature's forces.

The Utron electrical accumulator, and the Carrotto gravity motor will make electricity a willing slave to do man's chores, carry him where he wants to go, and light the roads along his way. These two OTC devices, developed and applied in peaceful service to humanity, will lift you and all of today's generations of man into a new heritage of free abundance.

It is all yours to grasp and hold for a good life of free expression, free communication, and the free pursuit of opportunity.

It is the promise fulfilled of:

*"Peace And Plenty Through  
The Application Of Free Energy  
To Supply All Things For All People"*

## ABOUT OTIS T. CARR

*What, then, can we say in a few words that will properly introduce you to this man Otis T. Carr, through whose mind and muscle these bounties have been directed to us by the Universal Intelligence?*

*Carr himself answers the question: To those who would acclaim his genius by personal tribute, he says, "Genius is defined literally from the classical Latin, as the productions of individual accomplishment through intelligent guidance by one's guardian Deity."*

*"My guidance led me to learn the life-span conclusions that had been reached before my time by all the true philosophers who observed and discerned and recorded the immutable laws of universal truths."*

*"We have built our developments from well-known basic principles that stem from the works of the Einsteins, the Teslas, the Faradays, and the dozens of other free thinkers who held truth and integrity above all material gain or loss. Even in many cases like the martyred Bruno, suffering the pain of torture to sustain beliefs."*

*"Essentially, what we have done is collect, arrange, adapt, and orchestrate some of Nature's compositions into harmonious assemblage."*

*"They are fashioned out of God's Creation."*

*"They are instruments of peace."*

*"Their music is for all the worlds of man."*

\*To qualify for instructions to fabricate and use an ENERGIZED Utron electrical accumulator, which in even the small size shown here has multi-ton energy potential, please write OTC Enterprises, Att: Operations Manager, giving your profession, your age, occupational affiliation, and technical facilities.

Patents pending on all designs - © Copyright 1958 by Otis T. Carr, Baltimore, Maryland - ® Trademark Registered by OTC Enterprises - ® Trademark of OTC Enterprises - The designs and all statements published hereon are the novel and original developments of Otis T. Carr and the OTC Enterprises. They are fully covered by the conventional legal protections of the United States and other countries and may not be reproduced for resale, re-use, exhibition, or for remuneration or gain without specific consent in writing from OTC Enterprises Incorporated.

WE HAVE WON THE RACE INTO OUTER SPACE

There is much talk about Rockets and Missiles and about the years and money it will take to get to the Moon and back or to make a platform where we can watch over our 'enemies'.

The total answer to space travel has long been contained in our pertinent summation of physical law that: "Any vehicle accelerated to an axis rotation relative to its attractive inertial mass immediately becomes activated by free space-energy and acts as an independent force."

This is the equation that can get us to the Moon or wherever else in the solar system we want to go---at small cost and without blasting ourselves off the face of the earth.

We have twenty years of research and know-how and will build our OTC spacecraft for peaceful travel and transportation. Yet it is plain fact that the OTC-X1 is the ULTIMATE MISSILE because being manned in outer space it can pick off any other device now being made or planned and is now being offered to the United States Military for whatever purpose they choose to use it!

Meantime, OTC Enterprises will proceed with its plans for the peaceful manufacture of free-energy systems and manned spacecraft in the belief that Americans under God can equal or surpass the technology of any nation on earth.

Otis T. Carr, President  
O.T.C. Enterprises, Inc.



Imagination and creative ability are among our assets, for which no definite limit exists. The Creator of the Universe has the complete monopoly on power-atomic or otherwise. Many lasting inventions originate in the minds of individuals from all levels of society, of all degrees of temperament. Thus, discovery can come from meek and humble sources as well as from the chambers of wisdom. A new age of energy application is upon us, and understandable knowledge of spiritual transmutation and material transmutation is at the threshold. This new age of science, discovery, and adventure is indeed thrilling as we find ways to realize that energy is perpetual, matter is perpetual, and life is perpetual.



Trademark of OTC Enterprises Inc.

- ⊗ The Gravity Electric Generator
- ⊗ The Utron Electric Battery
- ⊗ Solar Energy Devices
- ⊗ Electro-Magnetic Machinery
- ⊗ Free Flight in Space



"OTC ENTERPRISES INC. FACES THE PRESENT AND FUTURE WITH FAITH, COURAGE, DETERMINATION, HIGH HOPES, AND THE CERTAIN KNOWLEDGE THAT OUR WORK WILL BE AMONG THE FOUNDATION STONES OF THE COMING FREE-ENERGY SYSTEM"

## CAROTTO® DYNAMICS INC.

### Introduces the Carotto GRAVITY MOTOR

We have introduced the CAROTTO GRAVITY MOTOR as an electrical engine. It has many other applications. A compressor motor to build up pressure in hydraulics will surely be one essential application; and of course, it has a wide application in all forms of mechanical use aside from electricity. Our investigation of the atom in the middle thirties led us to this novel discovery. Here you will see the first physical correlation of natural forces at work in four-dimensional application.

You need only look around you to see the need for many fruitful applications of this new controlled-energy source which may never be practical with the massive devices now being built and planned around reactors using fusion and fission procedures to derive power from the atom.

The Carotto Gravity Motor is portable. It requires no fixed location or large building in which to function.

The Carotto Gravity Motor is flexible. It can be made in whatever size best suits the purpose of application.

The Carotto Gravity Motor is safe. It requires no massive shielding to protect people from deadly radiation.

The Carotto Gravity Motor is limitless. It can produce whatever power is desired for practical application on earth or in space.

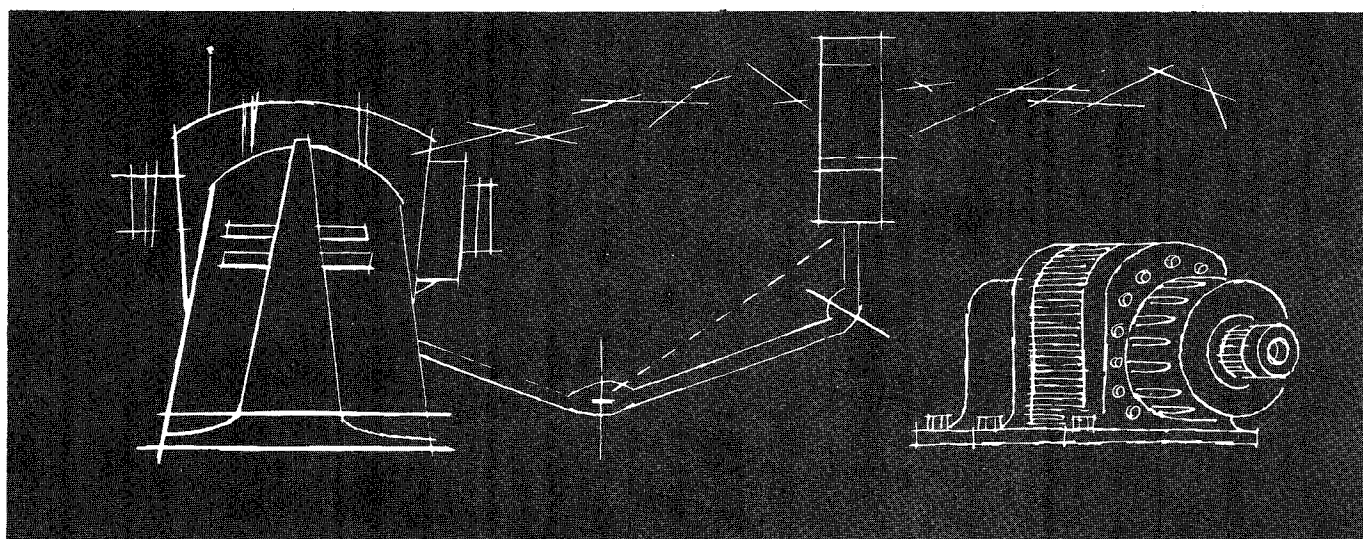
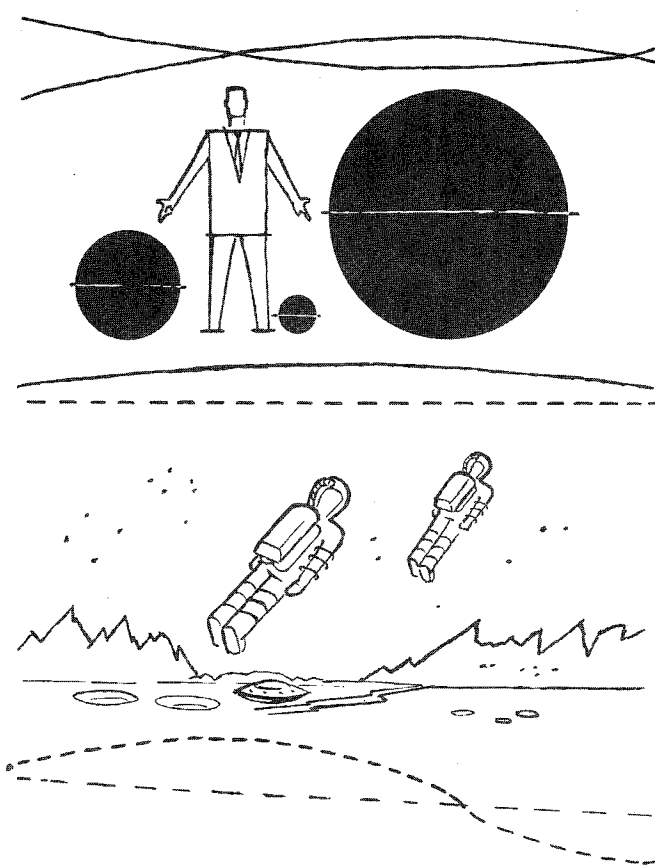

The applications of the mighty, unlimited power described in part on these pages must be handled with caution and great care, for economic reasons.

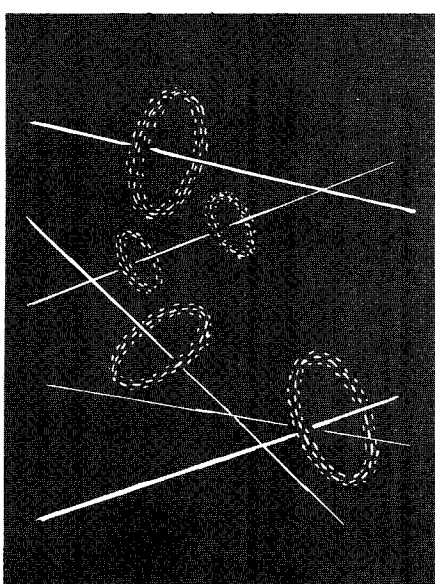

We are aware that any and all inventions in the physical world eventually result in betterment for all of society. We are also aware that radical changes can cause undue hardship on established operations that have reached a peak in our economy during a long steady growth.

There has always been a great hue and cry from the leaders of the work force that new discoveries would cause great hardship to masses of people through unemployment. Within our memory we have read or heard that everything from the cotton-gin to the electronic computer would cause economic catastrophe. None of this has come to pass. Each and every new device of modern commerce and industry has created new fields of endeavor with new and larger employment opportunities for everyone.

Today's proportion of per-capita employment and per-capita share of gross national product is at an all-time high.

In fact, we have reached a turning point at which we must begin to wonder where tomorrow's employables will come from to man the desks and machines for future supply in an expanding economy.

A generally accepted prognosis of the next twenty-five years is that, "White-collar workers will be far more numerous... people who run things will be almost double in number. Population will go up some 20% by 1967 (50% in 25 years) but the number of people available to work will increase only about 5% or 6%. This trend is manifest throughout the world.

As a consequence...the pressure to produce more with fewer people...will affect all business planning."

OTC Enterprises will be a powerful factor in the new balance between man and the machine. New opportunities will be opened for the educated white-collar force of course, and for as many such as our schools and colleges can produce. But even more important - WE WILL REPLACE THE NEED FOR THE BRUTE ENERGY FOR WHICH THE WORLD HAS TOO LONG LEANED ON THE RAPIDLY DISAPPEARING BLUE-COLLAR and NO-COLLAR WORKER.

We will not stop until we have penetrated our great discoveries into all the ends of the earth, or even as far into outer space as man desires to go!

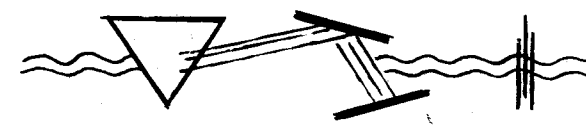
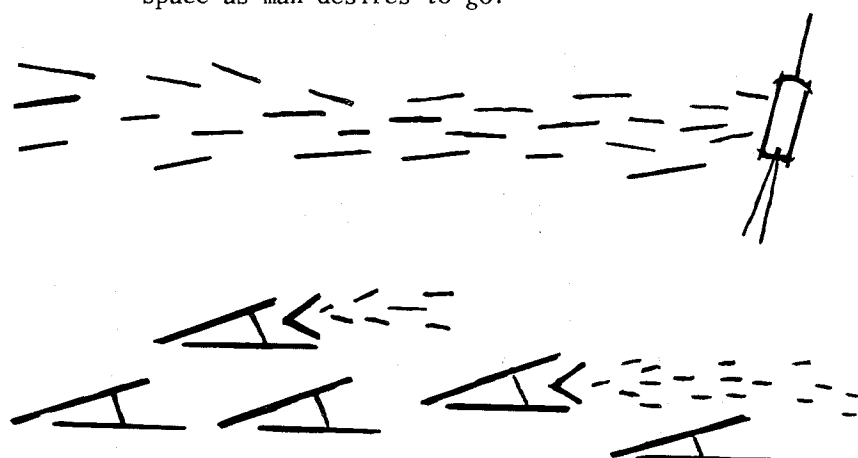

### THE PHOTON GUN

A unique reaction chamber wherein the controlled direction of radiant energy can be applied into an acceleration of mass approaching the velocity of light itself. This is primarily a development for use outside the earth's atmosphere. We are entering the age of space flight, and the use of solar energy in such is practically unlimited.

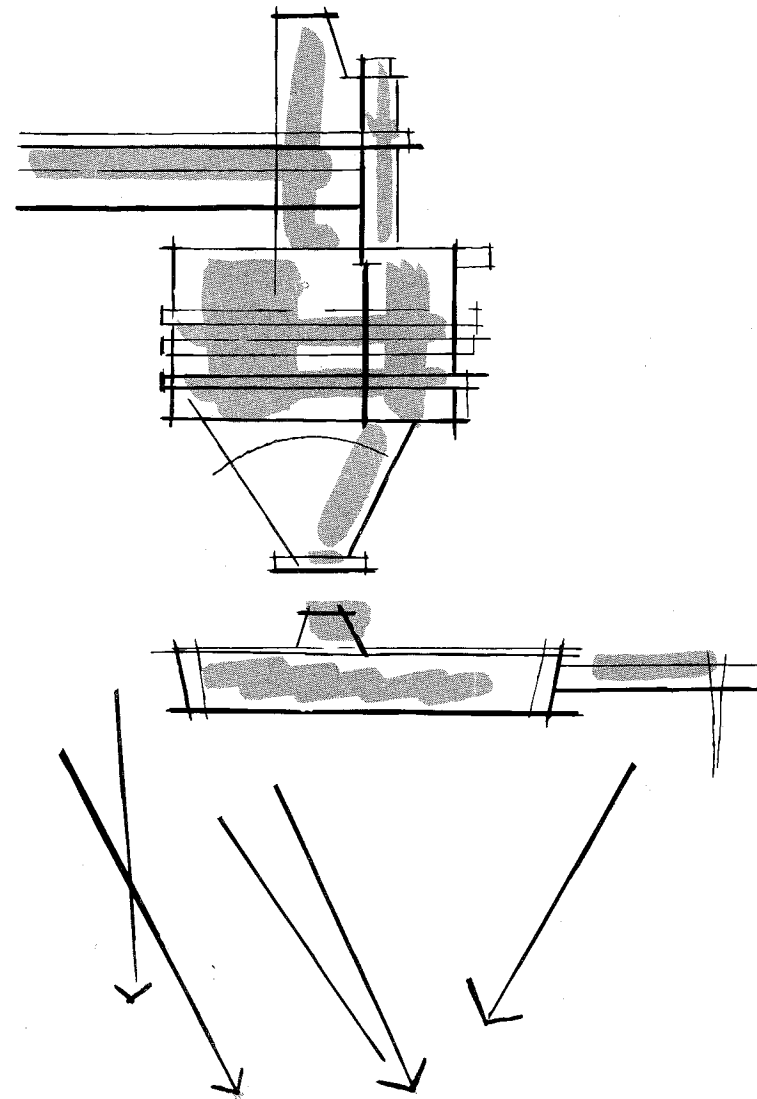

There is great simplicity in designs that refract light. We cannot show the same here without undue disclosures. Our experiments and investigations have made known to us that the mighty power from the Sun can be utilized when the geometry of design is properly evaluated. We are aware of the resistance factors involved, due to the earth's atmosphere, and our developments have been predicated on overcoming these, which in some instances has been done.



### We have invented a fourth dimensional space vehicle

This Fourth Dimensional Vehicle is powered by the revolutionary Utron electric accumulator, which is completely round and completely square, and generates its own power, which is electro-magnetism and electromotive force. It can be launched from the earth, and does not have to be blasted into space. The basic design was brought to the attention of the United States Government, and a patent application was filed in 1949.

Some tests were independently made by qualified engineers at one of America's leading plants and it was estimated that a small model, only four inches in diameter, produced energy equivalent to one-thousand tons. This was in 1952, and Mr. Carr was unable to interest anyone in his efforts at that time. Things have changed, and the Government has now put its blessing on space-flight development.

At the present time the rocket enthusiasts are commanding topmost attention. But there will be changes in thinking, and new directions of endeavor very soon. Our experiments with circular-foil design, as relates to gravity, electro-magnetism, and electromotive force, have led us to the certain conclusion that it is possible to use the inverse-proportion laws of Newton as successfully as the third law of motion applies to accelerated rockets. We will produce the OTC-X1 circular-foil spacecraft as the first operational prototype as symbolized in this conception drawing.



THE **Atom**  
IS GOING PLACES  
*without fission or fusion*

The terrifying magnificence of nuclear explosions makes one feel that the "Right Hand Of The Almighty" has been touched to cause a short circuit. Atomic war is unthinkable. Nevertheless, our beloved country is and must be ready to defend against aggression at all times. The efforts of OTC Enterprises Inc., are directed toward the peaceful uses of atomic energy. The applications of this colossal power start the millennium of an age of plenty and freedom from want beyond the fondest fancy of the most optimistic. We shall not attempt to question or encroach upon what has been done. Our plans and actions will stem from our own discoveries, the inspiration for which has been built upon the shoulders of giants.

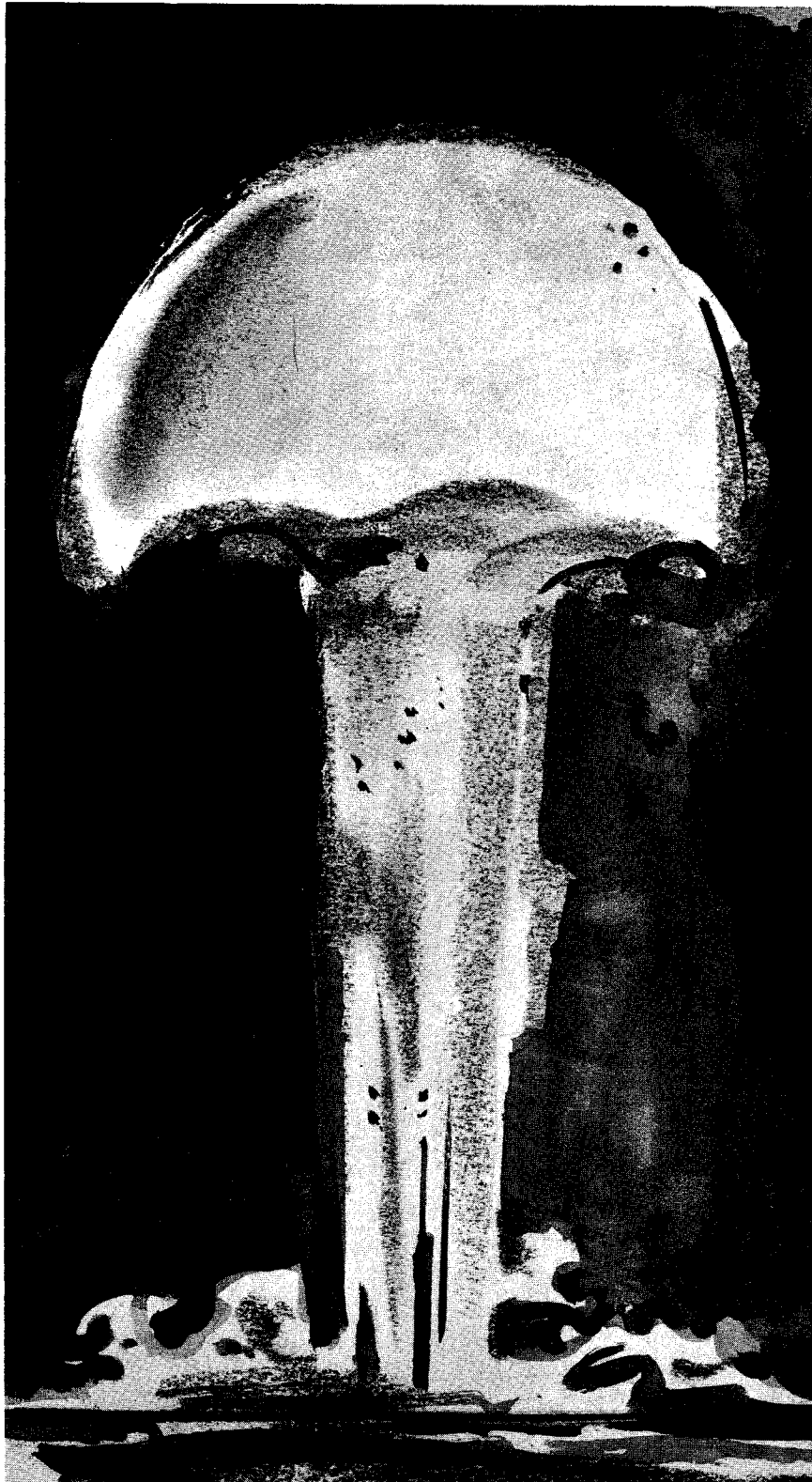

*Fossil Fuels are being exhausted*

The utilization of electromotive force for light, heat, and power is the great engineering problem and achievement of this age. Beginning with crude windmills, water wheels, and other primitive devices, the bulk of the load has been carried by wood, coal and oil, recently supplemented with considerable additions of water power in giant hydro-electric systems. The homogeneous reactor with nuclear energy is now entering the field, but its product will be expensive for some time due to the cost of processing the heavier elements, their scarcity and the ponderous problem of shielding their deadly, radioactive emissions.

With it all, there is far from enough to supply the world's needs, and our available supply of the fossil fuels is fast being exhausted.

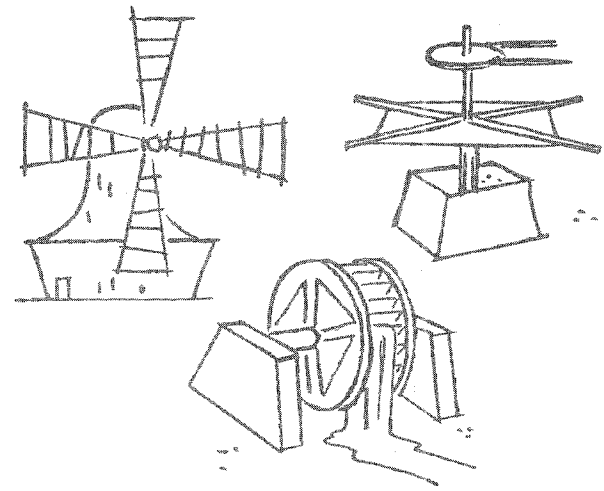

The free-energy concepts announced here for the first time are easier to grasp if you will consider them in terms of the commonplace free transfer of energy exemplified by the wheel, the lever-&-fulcrum, the pulley, and the pony-brake. You have long taken these forces for granted in familiar devices like the windmill, the waterwheel, the photoelectric cell, and even the energy-transfer devices in your automobile and your building elevator. While relatively primitive alongside the Carrotto Gravity Motor and the Utronic Electromotive Devices, they are physically only a step apart and have been within man's reach since he first began to think.

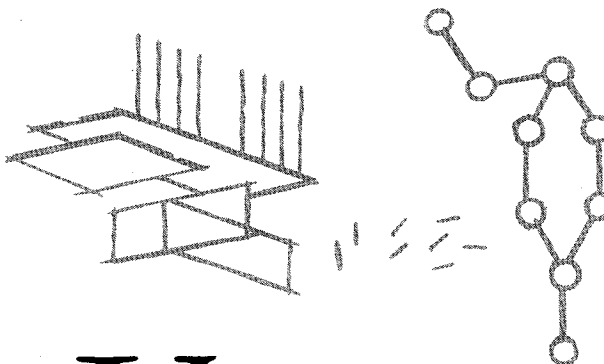

*Utronic Atomic Development Inc.*

UTRONIC ATOMIC DEVELOPMENT INC. is exploring new methods. We are not competitively concerned with the electronic field as such. We are concerned with means of supplying the current that lights and heats thermionic valves, photoelectric cells, cathode-ray tubes, automation-computers and other similar devices and their functions.

We have unlocked secrets of fractioning the lighter elements, which are in cheap and plentiful supply all over the earth and in the vast oceans. We have found revolutionary means of releasing their limitless potential energy in practical devices of tiny size and portable weight.

Beginning from the working pilot models, which we have achieved in prototype, our broad researches are aimed at commercial atomic-power applications to every conceivable device from hearing aids and portable television sets, to space cruisers that will without the slightest doubt be carrying parties of explorers to the Moon within the next few years of your lifetime.

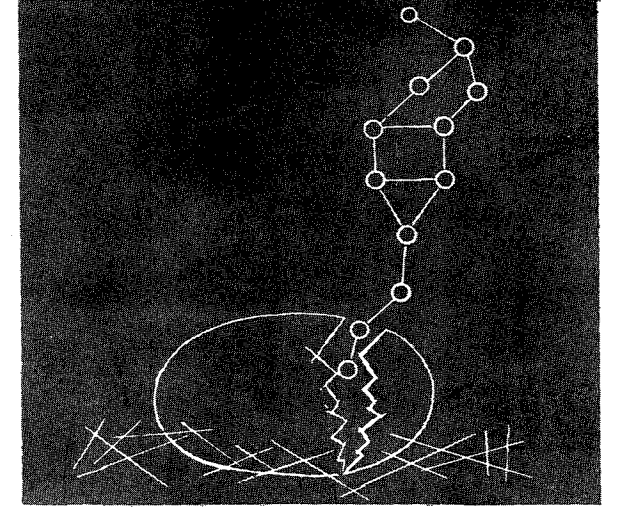

THE ATOM  
*and its secrets*

Now evaluated for the first time, and added to the Electron, the Proton, and the Neutron, is UTRON, the molecular shell that houses the atoms. The cohesion of "molecular shells" is brought about by inertial systems in the gravity field manifested in the two poles of natural magnetism and electro-magnetism. The states and conditions of this cohesion of molecular shells are evaluated in time by clocks at designated straight-line points in the field condition of space. The orbit of these molecular shells is definitely UTRONIC and is demonstrated considerably in nature. In the simplest form of empirical physics and mechanics it manifests in natural magnets, particularly in U-shaped magnets, and electro-magnets, and in electrical energy by wave transmission or conducting wire.

The point of inertia is the birthplace of the atom and its molecular shell, and if there were but one inertial system in the universe, then the molecule and its atoms would disappear into incomprehensible infinity. The cracking of the molecular shell of the atom always releases energy; the amount depending on the conditioning or "Hatching" process. By a very common and rather crude comparison, one can crack the shell of an egg and spill out the energy of its contents, or one can gently "hatch" or condition the egg to bring forth the energy of LIFE and its cycle of chain reactions.

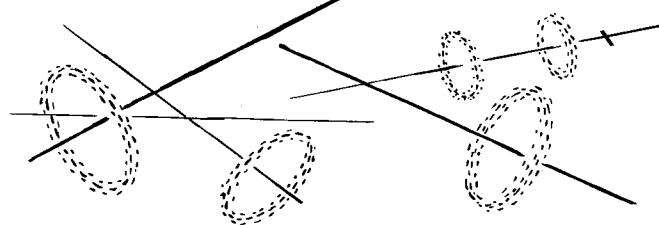

Descartes, Riemann, Mach, and Minkowsky realized and visualized the relative conditions of matter and energy, and the late Albert Einstein proved mathematically, and beyond question, that all types of matter could be converted into pure energy when conditioned into the velocity of light squared. My own equation on this was brought to the attention of Columbia University in the late thirties in the observation that a square supported by a center axis rotated at the velocity of light would result in a complete curvature of the mass involved. The physical demonstrations of Dalton, Maxwell, the Curies, Rutherford, Lawrence, Bohr, Fermi, and others, have produced the present physical demonstrations of Atomic Power.

Regrettably, fission and fusion are extremely limited in the element scale, whereas simpler forms and conditions of "Hatching" to the cracking point of the molecular shell of the atom remain to be explored. Unquestionably, all para-magnetic and diamagnetic elements invite experiment by transmutation. The element "BISMUTH" should be made to produce as much energy as Uranium and Plutonium with much less effort. The secrets still held within the orbits of energy present many enigmas, and with some diffidence I proceed to make public this new knowledge of the UTRON as a subtraction from the sum of the unsolved equations of the atom.

*Otis T. Carr*  
Otis T. Carr

Witness:  
*George A. Mahone*  
George A. Mahone Baltimore, Maryland  
*Thomas D. Burnett*  
Thomas D. Burnett May 7, 1955

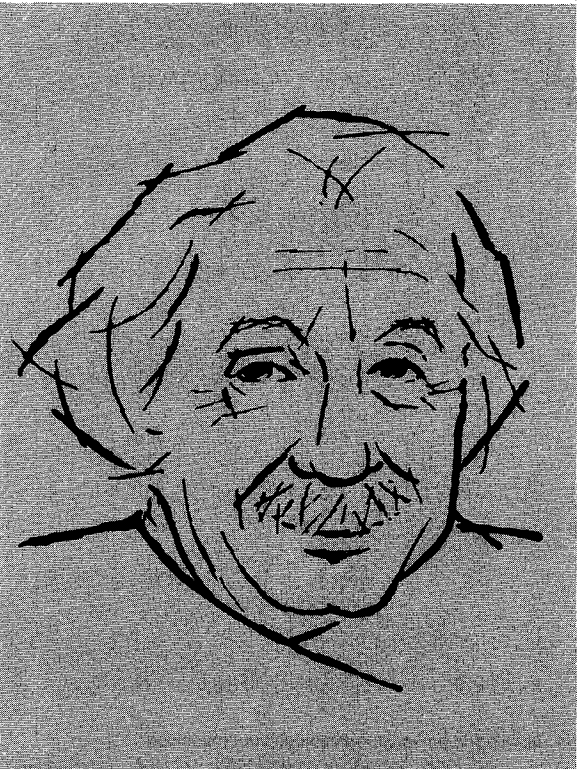

DR. ALBERT EINSTEIN

Truly the greatest mortal intellect of all time regarding the physical material universe. His mass, energy, and time equations have inspired thousands of mechanical developments in science. Our beginning enterprise is guided to a considerable degree by the simple quotation below:  
"If space were infinite, matter could be made to disappear."



OTIS T. CARR

"The dimensions of pressure are straight line; the dimension of motion is a curvature. Pressure creates motion and motion creates pressure. Therefore, motion is dimensionally fourth. Finite space is a condition of the field, and the static universe is as real as the kinetic one. From the spawning point of inertia, numerous dimensions beyond the fourth are logically equated - static or dynamic, all matter is available energy- IT IS AS SIMPLE AS THAT."

At about the same time Dr. Einstein enunciated the formulae to validate the practical release of destructive forces by atomic fission and fusion, Otis T. Carr began his original search for the equation by which these same forces can be released under peaceful confinement in harness to productive machinery. After sixteen years of exhaustive exploration in physical research, Mr. Carr has created the prototype mechanisms he envisioned as potential in the theoretical conclusions of Albert Einstein.

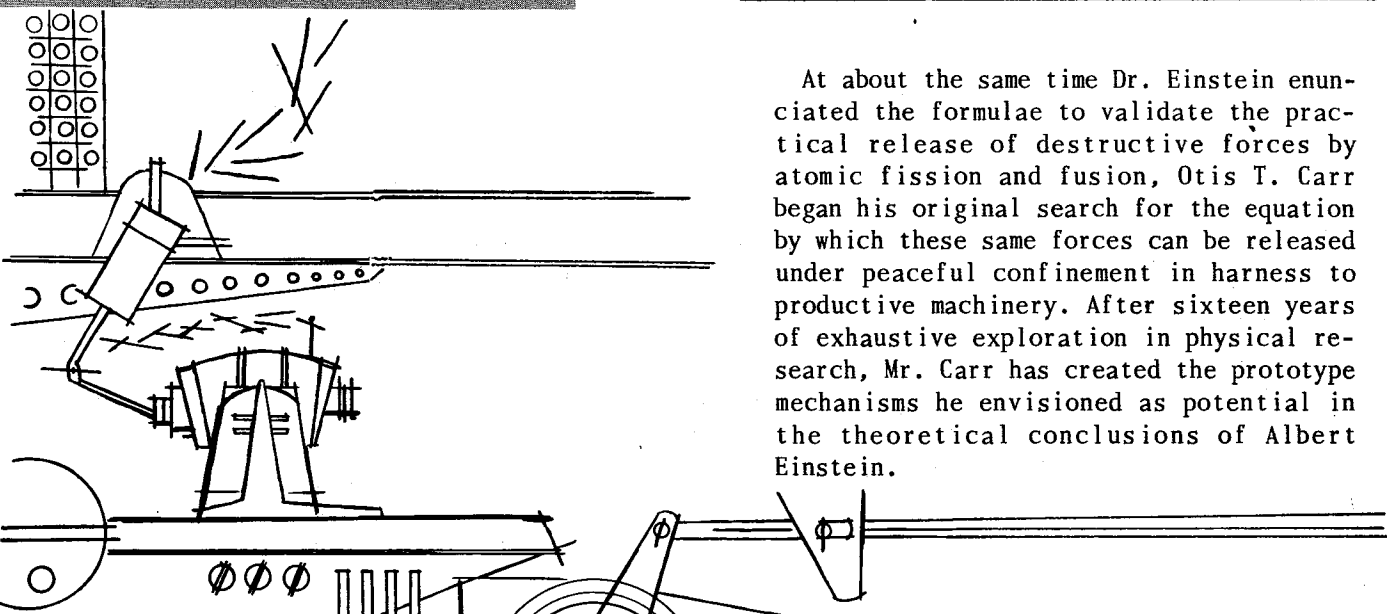



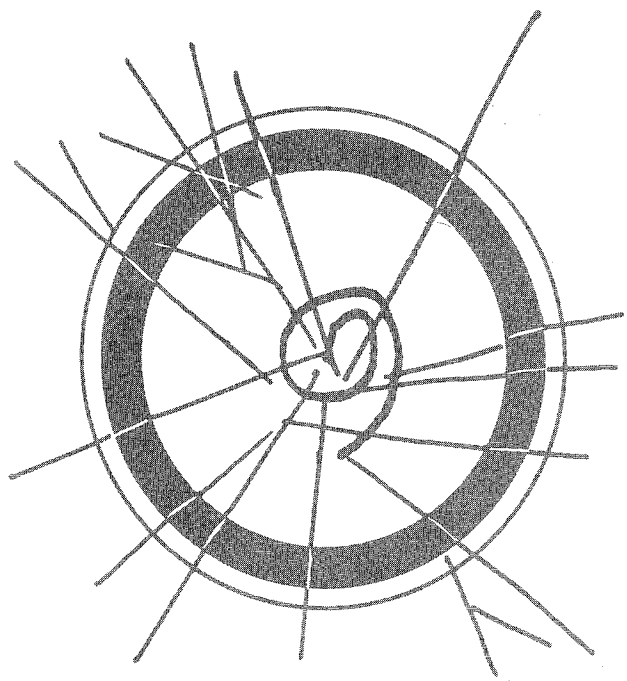

## FOURTH DIMENSION

Carrotto Dynamics Inc. is dedicated to development in fourth-dimensional power. Magnetism, electro-magnetism, gravity, and space are energies of the highest potential. The manner in which we apply them is an exclusive novel secret of our enterprise. Many of our experiments with pressure created by gravity and linked to motion, have succeeded. We have tapped an universal source of energy and have produced successful pilot models of demonstration. Our developments will be one of the major replacements of dwindling fossil-fuel supplies, and other irreplaceable combustion materials. Our first operating plant for the conversion of electricity by generation into heat, light, and power, will be the pioneering change of this era. It will be built when funds are available, and under our control in an appropriate legal entity.

We are ready to begin production of these power units as soon as funds are available for the building shown at the extreme right in the handsome, full-color architect's rendering inclosed for you to have framed for wall hanging. It should be clearly understood that commerce and industry are ready and waiting for the resulting power-packages, and can use them as prime-movers in conjunction with existing equipment and machinery. These are not visionary devices or improbables that will require entirely new concepts or designs in order to be employed in profitable applications. They are physical, material, real devices now in being and ready for the people!

True, the early availability of these new energy forms will undoubtedly lead to the design and development of new concepts in both stationary and mobile forms for production, transportation, and habitation. Future factories, office buildings and vehicles will adapt economically to altogether new functional forms in order to avail and derive the utmost utility at a fraction of present costs.

But the first, and immediate output of Carrotto Dynamics Inc. items of manufacture will be eagerly absorbed into today's markets!

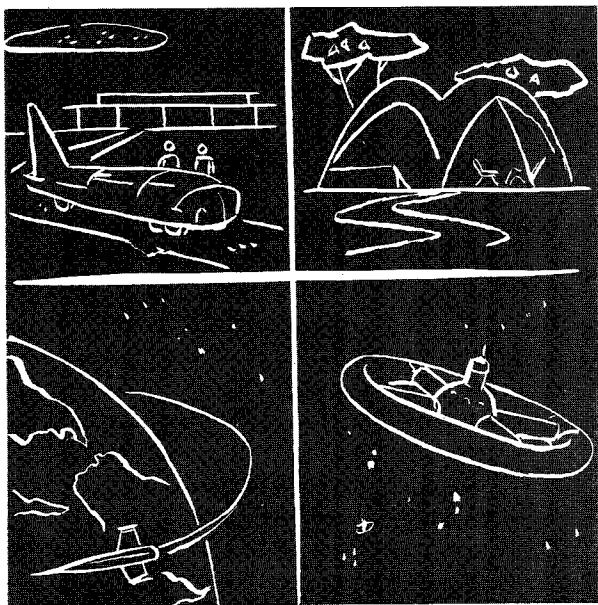

And wisdom in a single stroke  
Can lift from man the binding yoke  
That holds him to a star  
When in this broad vast  
Universe ten million  
Nay, ten billion are!  
Let's then repair to wisdom's lair  
Forsake the gun and saber  
Believe it's true  
A Columbus new will make  
of Mars a neighbor  
Let's scale the peaks of wisdom  
and make our goal a star  
And cry with everlasting Joy  
We are! We are! We are!



**Isaac Newton**  
*First to observe the inertial constants of universal bodies*

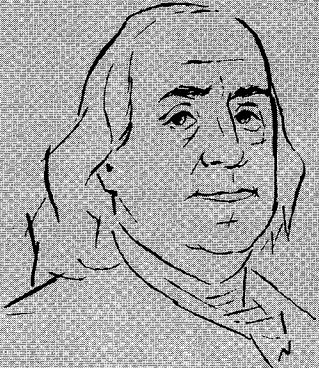

**Benjamin Franklin**  
*First to observe that lightning is free electrical energy*

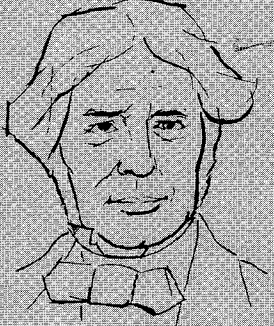

**Michael Faraday**  
*First to observe that the motion of a looped conductor in a magnetic field sets up an electromotive force*



**Francis Bacon**  
*This keenest observer of prerogatives dealing with the forces of nature deduced that man would most successfully harness natural forces by peaceful means*

## Free Energy SYSTEM

In the face of incredulity, we are able to state with full authority and responsibility that we have tapped an universal supply of energy in the form of gravity, and we have been able to harness the pressure energy of this force to motion, with the result that we have built and put into operation a machine that produces power continuously and absolutely free of dissipation.

Call this perpetual motion and science will laugh, as it has a right to. Certainly, parts of our machines will have to be replaced due to normal friction wear of moving parts under load. But the force that causes our machines to operate is as universal as the Sun and the Planets.

Much of the general public will laugh at this statement too, as they derided the great practical accomplishments of all the world's foremost thinkers from Galileo to the Wright brothers. Dr. Einstein's pronouncements were bandied about for years as grist for stage and radio jokes to the public's great amusement. But when the fuse was set and fired over Hiroshima, the atom bomb hushed the jokes forever.

You may laugh at the proposition of free, unrestricted, and undissipated energy if you are disposed to ridicule all that is new and which has not yet been commercially demonstrated. Or you may join with the spirit of those who put their faith and their dollars behind the efforts of pioneers like Henry Ford and became millionaires in a few years.

People seldom laugh at the 'horseless carriage' any more.

We have spent many years of intensive experiment, research, and investigation before meeting with success, and we shall be cautious with our disclosures. We can prove every statement and claim made here, which we will do when adequate protection for our interests is assured.

Emphatically, we state that we can generate electricity continuously at the lowest cost in history. In fact, the only cost will be the original investment, plus maintenance and replacement.

We enthusiastically proclaim "ENERGY FOR THE FUTURE-TODAY"

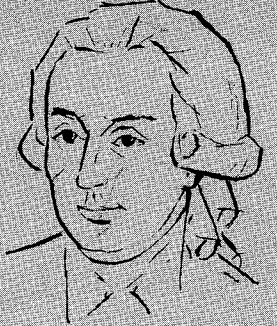

**Luigi Galvani**  
*First to observe that a certain association of dissimilars breeds electromotive force*

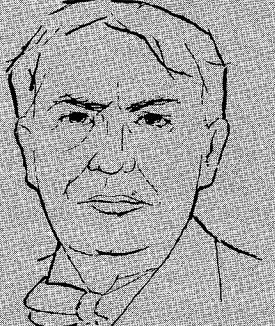

**Thomas Alva Edison**  
*First to observe the phenomena of thermionic emission*



**Galileo Galilei**  
*First to observe that the natural behavior of moving bodies is to accelerate at equal rate*



**Nicolaus Copernicus**  
*First to observe that the satellites of a sun orbit in a concentric plane*

## OTC ENTERPRISES INC.

## SOLAR ENERGY

OTC Enterprises has created original designs for devices by which the Sun's energies may be harnessed to supply commercially useful power for all applications. You have often heard it said that science will someday be able to use the Sun's energy for power. Note that the words 'will' and 'someday' are always used to express this belief. The *will* is because abstract theory has shown it to be possible, and the *someday* is used because up to now, no one had yet provided means to apply this great force to supply all our energy needs.

Our prototype experimental models have synthesized abstract theory into acceptable fact and practical assemblies of physical forms that will lead the way to the accomplishment of man's oldest dream - *not someday* - but within the foreseeable future!

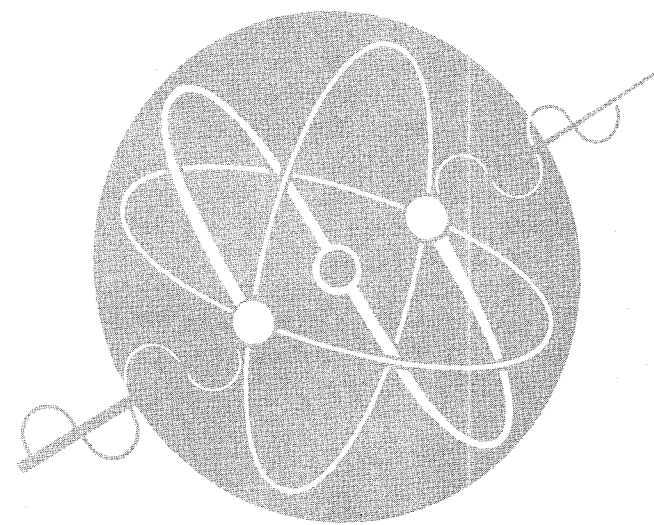

The giant, magnificent, Sun is the central power station for the planets of its system. This energy that comes from the Sun, if properly applied, would make all other forms of energy secondary or obsolete. The solar battery, which demonstrates a form of perpetual power, is a reality. We shall introduce several novel devices to utilize solar energy. Our experiments, based upon the certain knowledge that space is a condition of the field, the same as gravity and electromagnetism, bring high hopes that the tremendous power of the Sun, which is relatively less than nine minutes distant, can soon be harnessed beyond present comprehension. It is our unique knowledge that the geometry of space can be dimensionally and physically equated in prismatic form and assembly, and that the return of energy to its inertial source sets up a reactionary force.

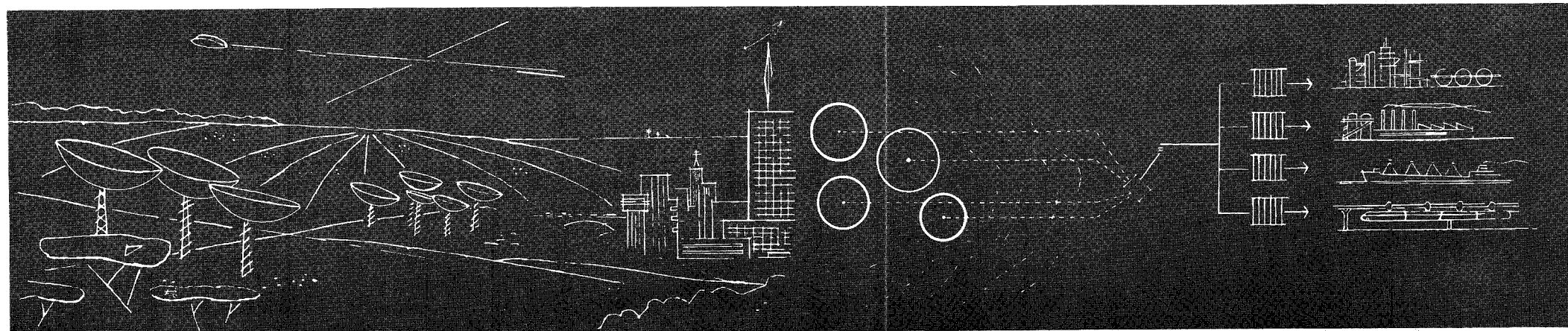



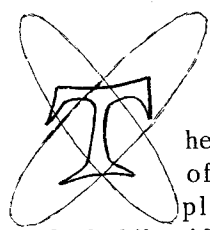

he photographs on this page are a series taken of the actual full-size model made from these plans, and faithfully show what your craft will look like if you work carefully and follow the plans accurately. These photographs are not retouched in any manner.

So let's take it step by step, do the right things in the right order, and who knows—maybe your model will be the one to win the big \$100.00 prize to be awarded personally by Mr. Carr next December 7th for the best in the land.

First, after you've bought all the materials, it's a good idea to make a set of templates. You could use these sheets to trace directly onto the balsa, but since most people want to save them for wall decoration in the workroom, it will serve the purpose better if you transfer the cutting lines onto heavy or stiff cardboard (like 2-ply Bristol or equal).

You can use tracing paper as a transfer medium, or else use carbon and a ball-point stylus.

After you've drawn the forms onto cardboard and carefully cut each flat-form template, lay out your balsa and mark the specified number of each part by pencilling the design onto the side of the wood you'll cut into.

Do a good uniform cutting job at this point and you'll save a lot of aggravation in final assembly.

When you've got all the parts cut out and finished ready for joining, the first thing to put together is the leading edge, for each of the hull assemblies, because when you get your true circle formed, it will serve as a sort of fixture for fitting and testing accuracy on all the rest.

Now you can start on the ribs, and here it's a good idea to butt the first two together across the diameter, to serve as a means-and-extremes guide for fitting the other ten.

Next in order is to assemble and fit the main spars and cross-ribs.

# OTC-XI

## YOUR FIRST REAL SPACECRAFT

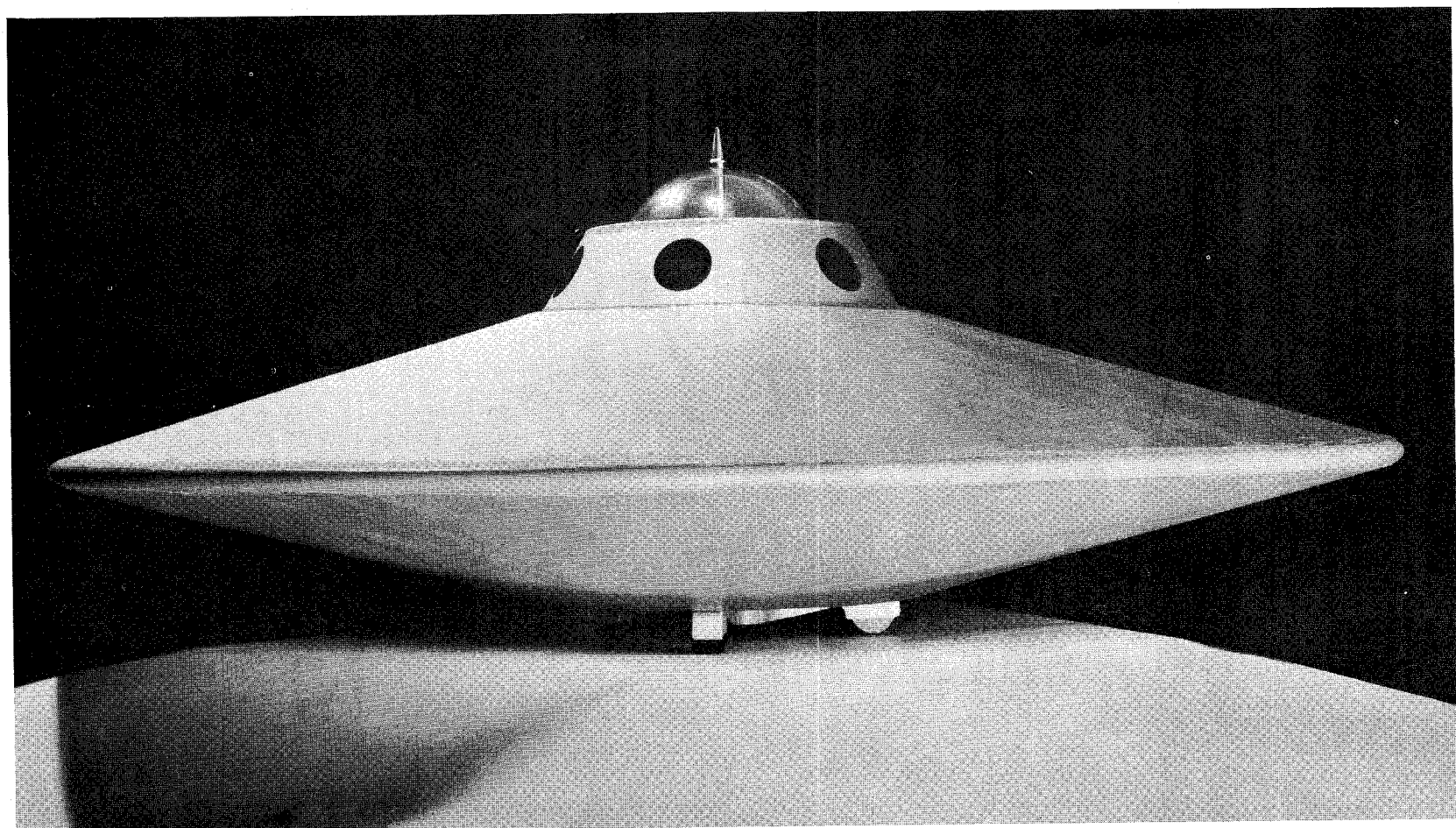

Your OTC-XI circular-foil Spacecraft will be your proudest work in modelcrafting. Its Spaceform of

handsome contour sculpts a profile for effortless lift and soaring velocity on magneto-gravitic waves.

Now mark the centers on your hull assemblies and make the hole for the main shaft and bearing, and for whichever type bearings you decide to use (sleeve or ball) now's the time to fasten the caps.

Next you can put the center disc assembly together, and the only clue you'll need to stay out of trouble here, is: WAIT to secure the trunnions in place until you've got the Utron generators set in their mortises for free-turning shaft alignment.

Then mount the center Utron accumulator on the center disc.

Wind your field-magnet coils with the plastic lacing.

Put the three-part landing gear together and drill it for the shaft. Position the shaft in the landing tripod, then position the hull assemblies on the shaft (to use as you would a "potter's wheel") for the fine-finish routing of the main-spar tips wherein you'll neatly nestle your Hula Hoop (equatorial-field correlator) AFTER YOU FASTEN THE COVERINGS.

Remove the upper-hull assembly, set the center-disc assembly in place on the shaft, and you're really in the home stretch.

All's left to do now is fasten the magnets onto the lower-hull spars, as said before, either fixed to stay or removable to allow disassembly, and you're ready to go to work on the cabin.

You're really pioneering now because the crew compartments and passenger lounges on OTC-XI Spacecraft can be

as spacious, commodious, and luxurious as the mind wants to imagine. Even palatial! For in these completely different-from-any-you-ever-heard-or-dreamed-of electro-gravitational Spacecraft of original OTC invention and design, there are no fixed limits on size and weight.

So when it comes to accommodations, you can either build the cabin as shown in the plans, or you can have a ball with your own space-age ideas for interior decorating.

If you do decide to trick up the interior with simulated controls, guidance systems, indicator panels, consoles, lounges, and other furnishings, naturally you'll want to construct your occupant-assembly with a removable roof and dome so you can show off your handiwork.

Good luck! Have fun!

And welcome aboard the first OTC-XI.

Patents pending on all designs - © Copyright 1958 by Otis T. Carr, Baltimore, Maryland - ® Trademark Registered by OTC Enterprises - ® Trademark of OTC Enterprises - The designs and all statements published hereon are the novel and original developments of Otis T. Carr and the OTC Enterprises. They are fully covered by the conventional legal protections of the United States and other countries and may not be reproduced for resale, re-use, exhibition, or for remuneration or gain without specific consent in writing from OTC Enterprises Incorporated.

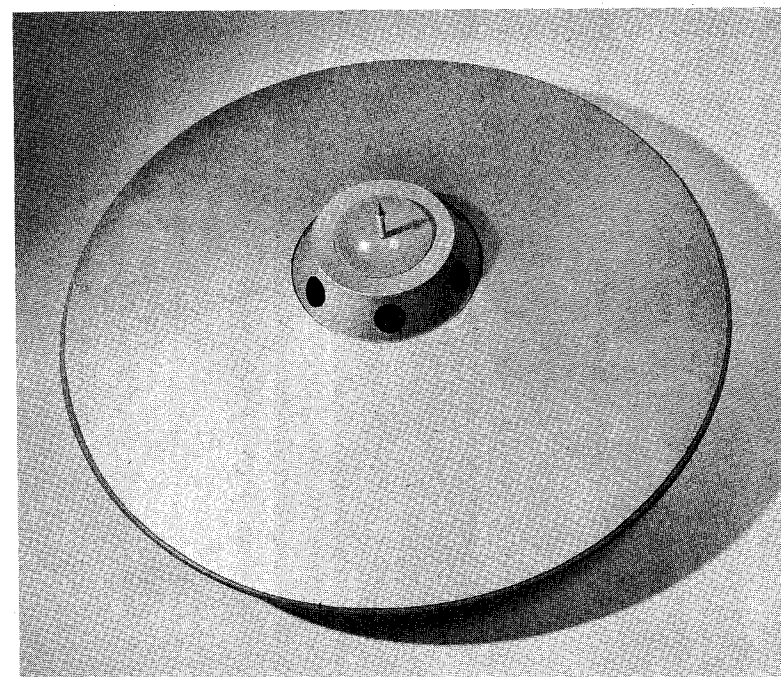

Do a craftsman-like job and your finished model will make you proud no matter how you look at it.

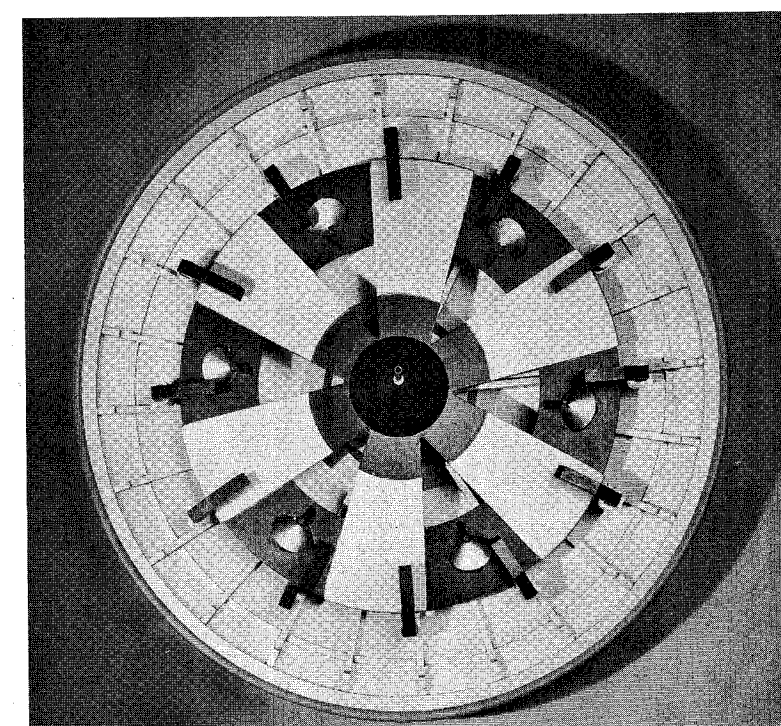

Ezekiel had the vision—Otis T. Carr saw it too. A wheel within a wheel for interplanetary travel.

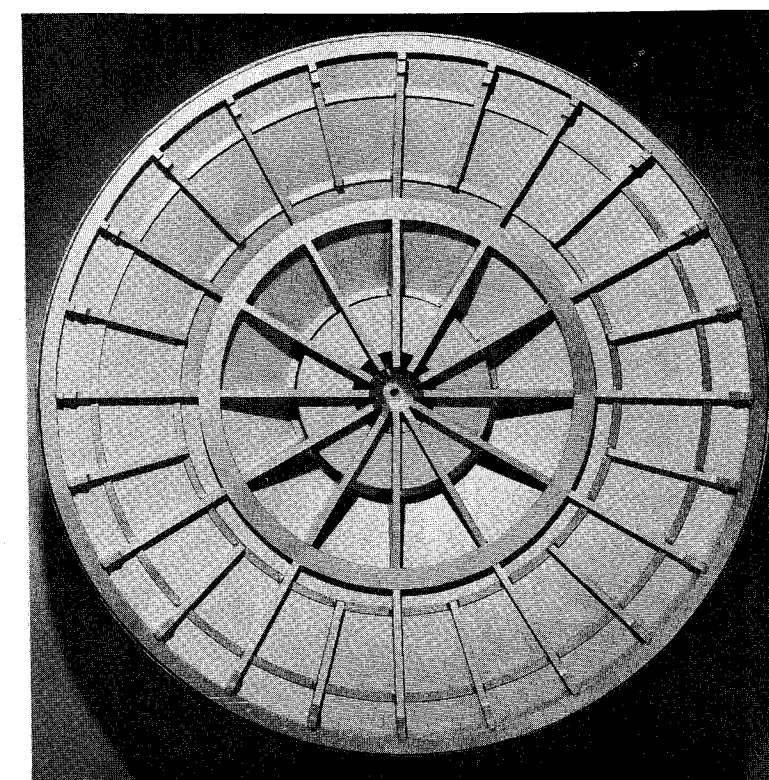

Spars and ribs combined in lacy geometrics form a hull structure of great strength and beauty.

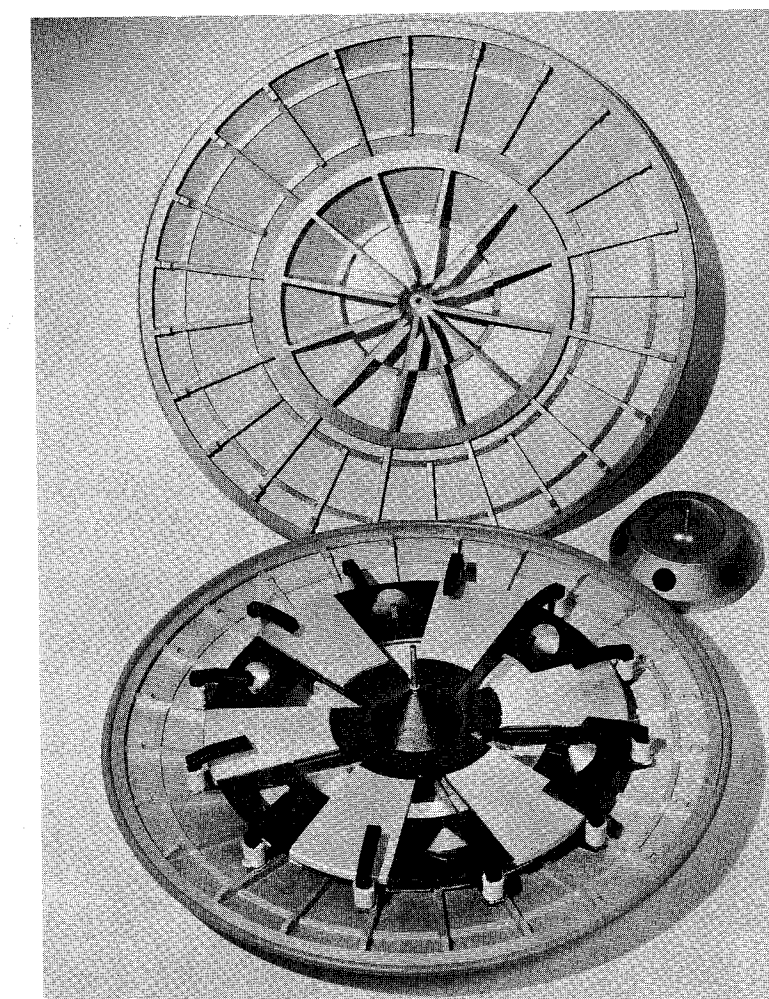

When all units are joined into major assemblies your OTC-XI Spacecraft comprises only four units.



**SPECIFICATIONS FOR THE UTRON ELECTRICAL ACCUMULATOR**

The Utron Electrical Accumulator as illustrated has thousands of specific functions as a prime supply of electrical and magnetic energy and mechanical motion. Its basic novelty and function derives from its physical form being a geometrical translation of the dimensions of space. The Utron Electrical Accumulator as shown, is completely round and completely square, being comprised of two right-angle cones joined at their bases to form a circular equator, and each having a central hollow hemisphere which when joined form a hollow sphere. As applied in axial and/or orbital motion as a part of moving machinery, the Utron Electrical Accumulator will energize and motivate such machinery from its own kinetic resources and will continually and without dissipation of productive energy have the capacity to be continuously re-energized itself by its own motions, so that it constantly avails its inertial potential in either static or dynamic states. These characteristics are the product of constant natural phenomena directly resulting from the dimensions of pressure and motion expressed in the geometric configuration of the Utron Electrical Accumulator (henceforth in these descriptions to be called the Utron for brevity).

Within the above stated broad description of form and function many variations of such form and function will be claimed and much experimenting remains for our research to determine the thousands of specific variables for optimum function to energy and motion needs of varying size and degree. For example: The Utron may be of any conceivable size. The Utron may be uni-cellular or multi-cellular. The central cavity of the Utron may be altered from the spherical to other desired shapes. The central cavity of the Utron may be chemically and/or physically activated by any of thousands of fluid or solid compounds from plain water and weak acids to metallic elements and rare earths either inorganic or of organic composition. The Utron itself may be comprised of any of thousands of substances or combinations of substances, some components or entities being either dia- or para-magnetic in character. The Utron can be put into effective function in basic form, in any of the compound forms categorized above, or in further combination with coil windings, printed circuits, inherent electronic components or circuitry, and/or many other physio-chemical components too numerous to delineate.

The Utron may be activated productively in motion in many ways as a voltaic cell, as a battery, as an armature, commutator, motor, generator, and even as combinations of these and other forms, either by itself or in assembly with other components such as magnets, coils, motors, levers, wheels, and planes. One such characteristic which is basic in novel concept, and important as new and profound translation of natural physical phenomena, is one manner in which the Utron may be coil-wound to act as an armature in an activated magnetic field; The winding is begun at the Utron's conical apex, spiralled to and across its equator, and terminated at the opposite apex. We have thus duplicated the most fundamental of all natural conditions under

*The Geometry Of Space  
In Fourth Dimensional Physical Form  
With The Revolutionary*

**Utron Electrical Accumulator**

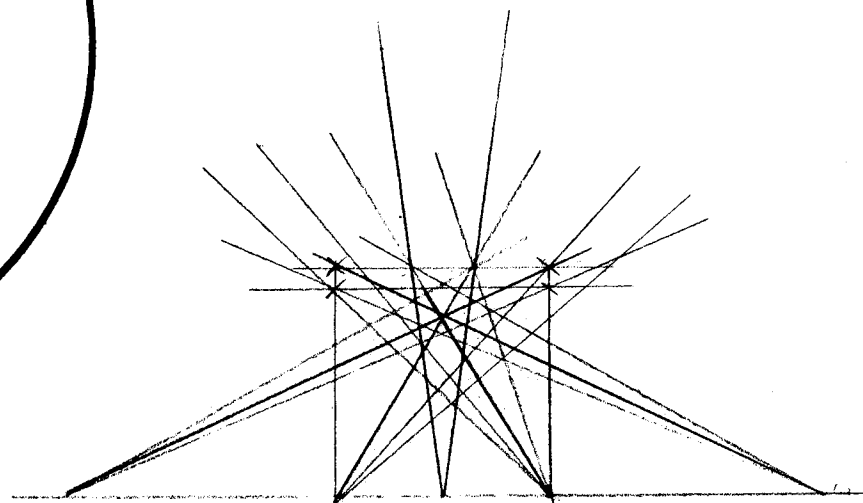
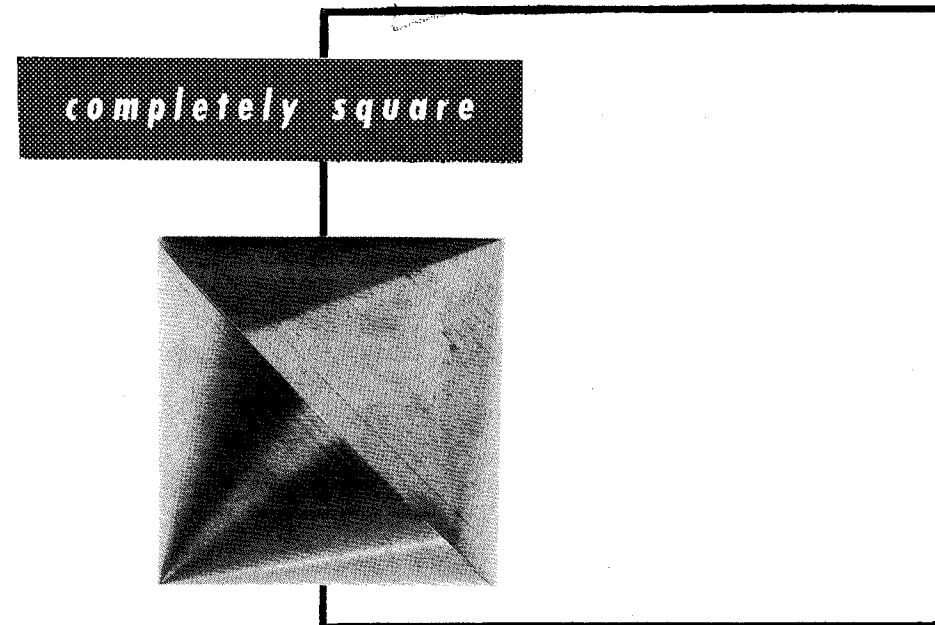
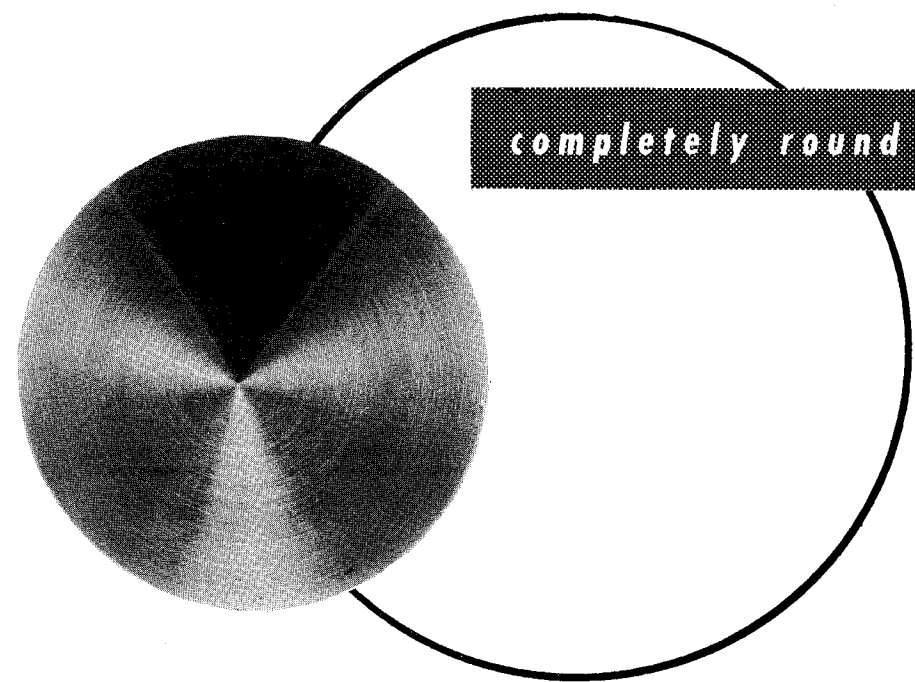
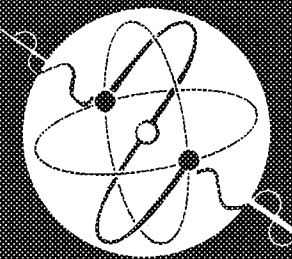

**A close-up portrait of the central power core for our OTC-X1 circular-foil spacecraft**

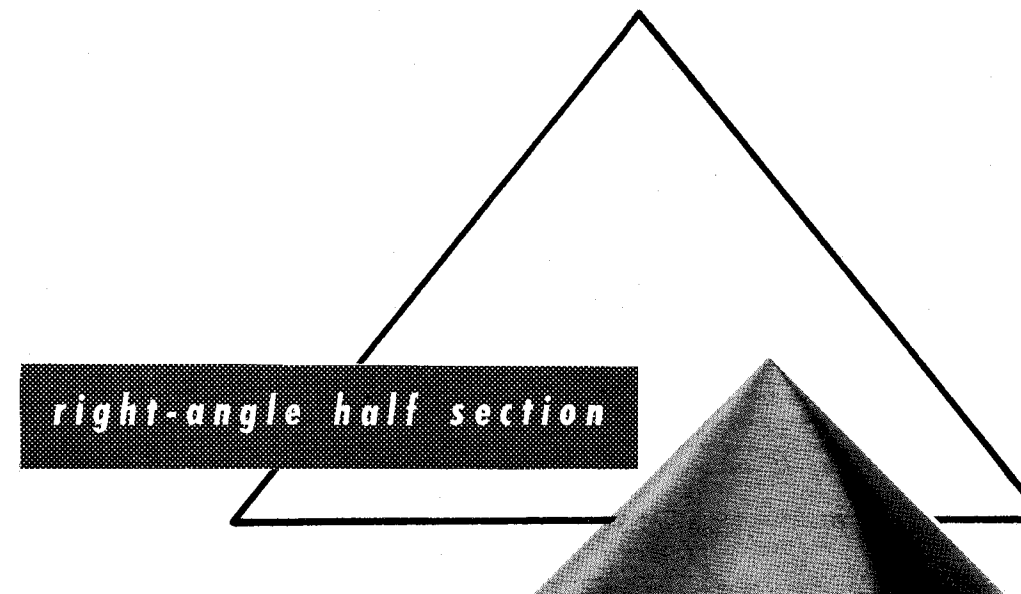
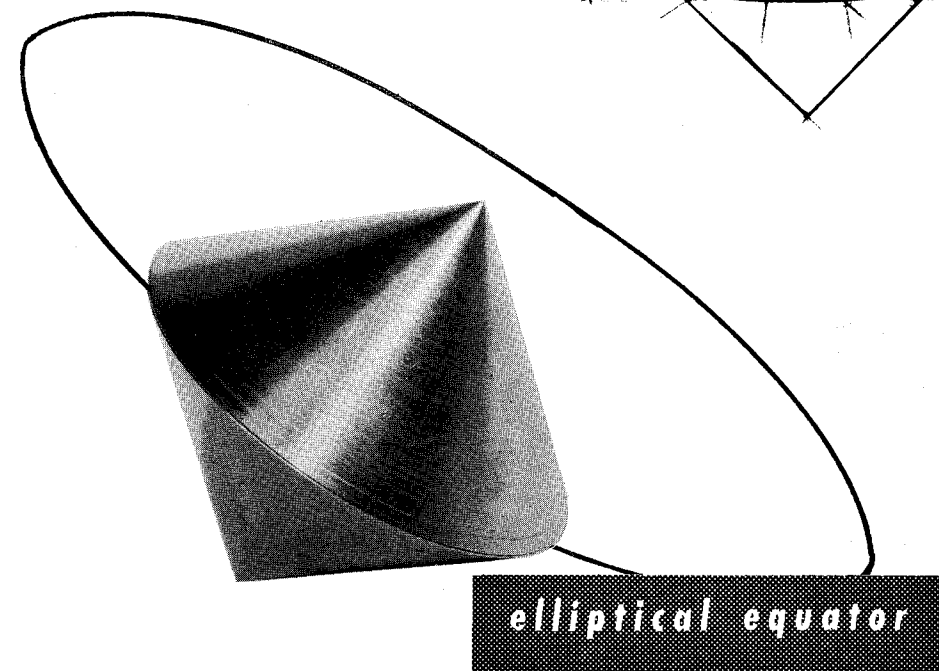
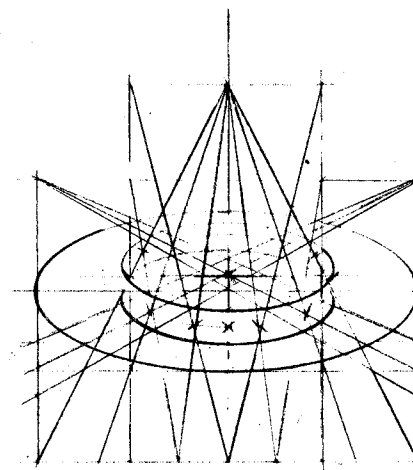
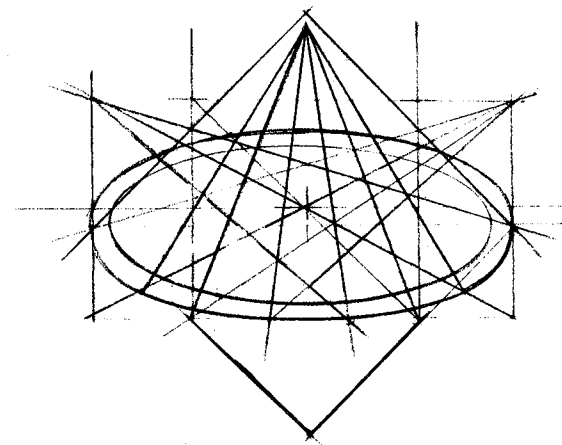
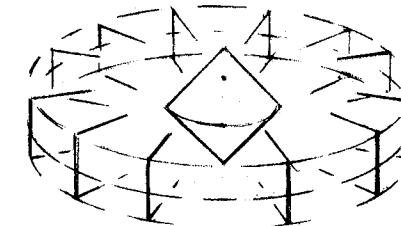

the most fundamental principles of natural constants, thereby deriving by immutable natural law the ultimate potentials of relative expansion and contraction, action and reaction, and material mutation and transmutation in the form of Utronic wave energy. These phenomena are novel, unique as inherent characteristics of our Utron, and radically different from all other manufactured electrical phenomena. As contrasted to the common conventional techniques employing looped rotating circuits, the Utron uses the full potential of the eddy currents set up at its equator on an elliptical angle of 45 degrees, thus uniting the straight lines of magnetic pressure force with motion to develop a fourth-dimensional space-time fourth-dimensional energy pattern which becomes uni-polarized in the inertial attraction of the affected mass and is actively repelled by the mass. When the equation becomes relative it is entirely released from such attraction and becomes an independent force in a universal field.

Another unique phenomenon, distinctly novel and unique as an inherent function of the Utron, is the manner in which space magnetism and cohesion manifest from interactions with fluids or other components in its central cavity, whereby such matter sealed within the area of its own mass enables the Utron to set in force energies inherent under the law of three points: inertia, expansion, and contraction.

Another of the novelties too numerous to specify here, is the extensive use of the Utron in mechanics to such uses as activated electrical bearings, which under load can perform as either friction or anti-friction devices using natural or energized magnetic fields and mutual conductance to perform lift.

A prime function of the Utron in propulsion systems is its ideal use in the power package of craft for aerial or space flight, wherein it performs energizing and self-reenergizing functions that obviate the use of other devices or substances to furnish dynamic inertia in any dimension of flight.

Finally, for this reading, the Utron lends itself in design to the incorporation of turbine-type reactor channels, which illustrate a novel arrangement of resistance sidewalls expanding to a block with a center escape channel that allows for external propulsion in rotation by any fluid or gas under pressure.

The above describe tests and experiments begun by me in the year 1938 and still continuing.

Signed and witnessed in Baltimore, Maryland 17 March 1958:

*Otis T. Carr*

WITNESS:

*Leoman S. Dalton*

WITNESS:

*Hedegard W. Shea*



PART NO.	QUANTITY	DESCRIPTION	NOTES	PART NO.	QUANTITY	DESCRIPTION	NOTES
1	12	Top Rib		15		Skin of Ship	Can be Balsa or Aluminum
2	12	Bottom Rib		16	12	Bearing Trunion	
3	2 Halves	Center Accumulator	Two Rt. Angle Cones Joined at Bases	17	6	Regenerating Accumulator	Twelve Rt. Angle Cones Joined at Bases
4	6	Main Spar		18	1	Cabin	Seven Parts
5	2	Circular Rib, Top		19	1	Leading Edge	Tubular Plastic or Fiberglass
6	8	Circular Rib, Top-Bottom		20	12	Mid Rib, Top	
7	8	Circular Rib, Top-Bottom		21	12	Mid Rib, Bottom	
8	6	Outer Spar		22	1	Plastic Dome	Top Section Cut from Sphere
9	6	Outer Spar		23	6	Accumulator Frame	
10	2	Circular Rib, Bottom		24	6	Central Rotating Assembly, Main Spar	
11	1	Top Bearing Plate		25	6	Capacitor Plates	
12	1	Bottom Bearing Plate		26	12	Coil Winding	Can Be Simulated By Plastic Lacing
13	1	Landing Gear	3 Parts	27	1	Vent Tube	Holds Cabin to Ship
14	12	Electro-Magnet		28	2	Main Shaft & Bearing	Either Sleeve or Ball Bearing

### SUGGESTED COLOR SCHEME FOR FINISH AND TRIM ON YOUR OTC-X1 SPACECRAFT

Since most modelcraftsmen shoot for authenticity in finish as well as structure, this suggested color scheme is adapted from the specifications furnished the OTC design engineers who fashioned the first display model in authentic miniature.

Of course, you can vary this scheme to suit yourself, or even change it from time to time when you give your model a fresh-up redecorating job. But if you do use these colors you will find the overall resulting appearance esthetically pleasing and exciting, while it is at the same time authentic.

Upper and lower hull assemblies - ALUMINUM INSIDE AND OUT  
 Center Utron accumulator - WHITE OR BLUE  
 Main Spar and frame - BLUE  
 Generator bearing tummins - BLUE  
 Utron generators - COPPER OR GOLD  
 Capacitor plates - ALUMINUM  
 Center Utron vent stack - GOLD  
 Simulated portholes - BLACK  
 Main cabin assembly - ALUMINUM  
 Observation Dome - CLEAR PLASTIC  
 Field-magnet coils - YELLOW  
 Landing-gear trunnions - ALUMINUM  
 Landing rollers - BLACK

### BILL OF MATERIALS

Here's the list of raw materials you'll need if you decide to build your OTC-X1 Model exactly according to these plans, which are based on a 25-inch overall outside diameter. Costs will vary slightly among different hobby shops.

NUMBER NEEDED	SIZE	ITEM DESCRIPTION	UNIT COST	TOTAL COST
4 only	1/4 x 4 x 36	Balsa Wood	¢ .40	\$ 1.60
5 only	1/8 x 4 x 36	Balsa Wood	¢ .40	2.00
4 only	3/16 x 4 x 36	Balsa Wood	¢ .35	1.40
1 only	1 x 3 x 36	Balsa Wood	¢ .60	.60
10 only	1/32 x 4 x 36	Balsa Wood	¢ .25	2.50
1 only	1/16 x 4 x 36	Balsa Wood	¢ .30	.30
2 only	1/2 x 3 x 36	Balsa Wood	¢ .50	1.00
2 only	26 1/2 x 33	Sheets Silk-Span	¢ .15	.30
3 only		Tubes Testors Glue	¢ .25	.75
1 only	6" x 12"	3/16 Plywood	¢ .40	.40
1 only	1/4 Diameter x 10"	Brass Tube	¢ .25	.25
1 only	9/32 Diameter x 10"	Brass Tube	¢ .25	.25
1 only	2' x 3' x 1/16"	Poster Board	¢ .25	.25
7 only	4-oz. Bottles	Dope and Filler	¢ .60	4.20
1 only		Plastic Sphere for Dome	¢ .98	.98
14 yards		Plastic Lacing	¢ .02	1.28
2 only	Small	Hulu Hoops (leading edge)	¢ .69	1.38
TOTAL				<u>\$18.44</u>

### CROSS SECTION VIEW

#### NOTE ON NOTES

To avoid a lot of waste conversation about sizes and materials, let's assume for clarity in all these instructions that you're going to make your model OTC-X1 Spacecraft from the materials listed and according to the actual sizes specified in the template contours on these plans. If you do otherwise you know what you're getting into, and you'll have to figure things out for yourself anyhow.

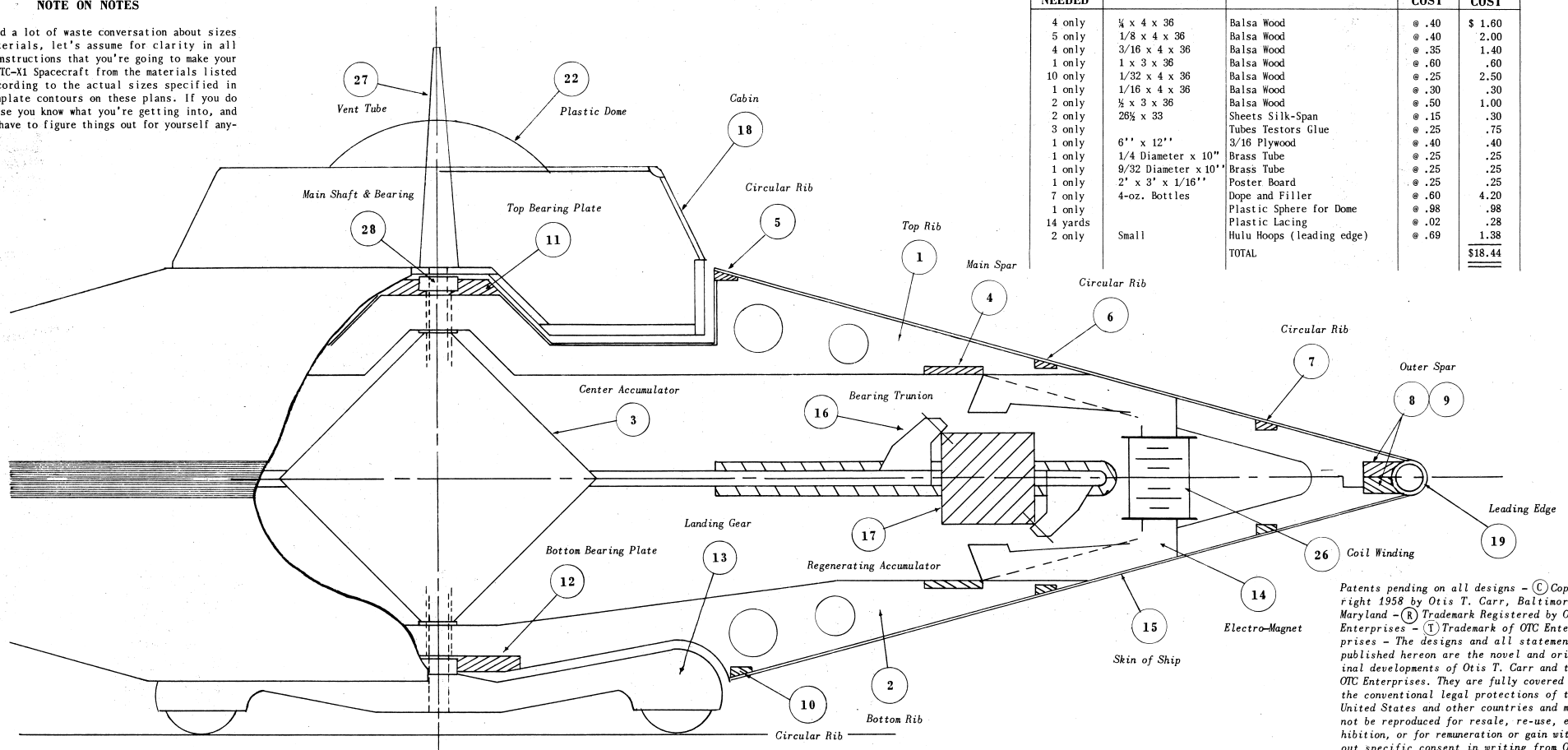

Patents pending on all designs - © Copyright 1958 by Otis T. Carr, Baltimore, Maryland - ® Trademark Registered by OTC Enterprises - ® Trademark of OTC Enterprises - The designs and all statements published hereon are the novel and original developments of Otis T. Carr and the OTC Enterprises. They are fully covered by the conventional legal protections of the United States and other countries and may not be reproduced for resale, re-use, exhibition, or for remuneration or gain without specific consent in writing from OTC Enterprises Incorporated.



"All who pass us by their way  
Back and forth to work or play;  
Pause to wonder, at the sight  
Of our antique carriage light.  
Why does it burn all night—all day?  
What message speaks within its rays?"



Here on this page for the first time, is the heartwarming answer. The undying light at 2502 North Calvert Street, whose electric glow spreads a welcome to all men of good will, marks the workshop of Otis T. Carr . . . it burns as a modern-day Candle in reverent memory of those great men of Science, from Archimedes to Einstein, who have made this announcement possible . . . the astonishing but true fact that the little house on Calvert Street is the birthplace of

# PEACEFUL ATOMIC ENERGY AND A NEW ELECTRICAL AGE

All energy is Atomic  
The Light from the Sun  
The Pull of Gravity  
The Fission of Uranium  
The Fusion of Hydrogen  
All that moves  
Or grows, Or glows  
Everywhere on Earth  
And throughout the Universe.  
It is all Atomic Energy.  
Its Uronic presence is everywhere, being even Nature itself.  
And held in plain view for all the time we know, it has yet remained Nature's closest secret.  
So, how to borrow of this energy from Nature, has been quite a problem.  
When you fight Nature, Nature always fights back.  
If we try to share Nature's energy by injuring Nature, we will only injure ourselves accordingly.  
Try to change the weather in one place and you get storms, or floods, or drought in another.  
Crack or split the Atom and you get frightful devastation or poisonous radiation.

And while you may blast a dog or a man away into space, you will never safely blast him back again. We know the laws of Nature do not change, so why waste the effort and take the terrible risks? There is only one right way. The right way is the peaceful way.  
And we have found the way. Now, in fulfillment of his lifetime dedication, Otis T. Carr can finally reveal the total answer!  
Mr. Carr has labored and studied and looked deep into Nature's mysteries for twenty years. He has learned many of her closest secrets.  
HE HAS FOUND THE KEY TO PEACEFUL ATOMIC ENERGY IN OUR TIME.  
Not only has he found the way, but Mr. Carr has teamed his efforts with a strong gathering of equally sincere men and women who are also dedicated to the common purpose.  
That unswerving purpose is to share the world and the rewards with you and all the other free people of the world.  
So now, in the Ordained year 1958,

they have established an American Corporation called OTC Enterprises in the office on Calvert Street, to broadcast the news far and wide.  
As surely as you are now reading this announcement, you are about to share in two of the greatest discoveries of all time.  
We have named them:  
THE UTRON ELECTRICAL ACCUMULATOR AND THE CARROTTO GRAVITY MOTOR  
They are both real, they are both here, and they are ready to go to work for you.  
They do not smash the Atom  
They do not split the Atom  
They do not blast the Atom  
They cannot injure, harm, or destroy any part of Nature or humanity, because they are machines of peaceful action.  
They are Natural machines that produce unlimited energy without Fission, without Fusion, and without Violence of any kind.  
Mr. Carr's two new machines are profoundly simple devices that collect and direct the Free and boundless energies of the Sun in

the same ways the Sun's energies cause the Earth to spin and the rivers to flow, the bread to rise and the plants to grow, and the great Ocean tides to rise and fall.  
The Utron Electrical Accumulator uses the Sun's magnificent force of Electromagnetism by means of natural reproductive chemistry.  
The Carrotto Gravity Motor, as its name implies, is powered entirely by the Sun's immutable pressure energy we call gravity.  
For the answers to both of these natural phenomena, Mr. Carr has looked into the smallest courses of energy in the Atom's tiny shell, and also into its vast reaches in the far places of the Universe.  
He has pieced together the simple truths that have been all around us since Time began.  
And strangely enough, these total principles are as familiar to you as are the names of the great men of history who knew and proved them one by one:  
Archimedes' LEVER  
Copernicus' CONSTANTS  
Galileo's ACCELERATION  
Newton's MOTIONS

Faraday's COIL  
Franklin's STATIC  
Galvani's ELECTROLYSIS  
Einstein's RELATIVITY  
Bacon's PREROGATIVES  
Edison's THERMIONICS  
The answers have been with us for many years. The bits and pieces of the puzzle have been lying around waiting to be assembled.  
Call it Destiny, call it Genius, call it what you will—it fell upon the mind and muscle of Otis T. Carr to organize the truths and apply the laws of Nature into his two great new inventions.  
You say How Great?  
The answer is found at the Masthead of all OTC Enterprises activities; it reads:  
"Peace and Plenty through the application of Free Energy to supply all things for all people."  
You say Fine, but When?  
The answer is:

**FREE ELECTRICAL ENERGY  
AND PRACTICAL SPACE FLIGHT  
HAVE NOW BEEN SOLVED!**

HOW WILL ALL THIS AFFECT YOU AND THE WORLD AS YOU KNOW IT? READ THE INSPIRING TRUE FACTS BELOW!

## OFFICIAL POLICY STATEMENT OF OTC ENTERPRISES

OTC Enterprises, developers of free-energy devices that will do the world's work cheaper and better by applying the magnetic and gravity forces of nature to useful machinery, and whose circular-foil spacecraft will revolutionize our concepts of flight and make space travel a reality within the next few months, give you these official answers to some of the important basic questions that have been asked:

### TRANSPORTATION

What does the OTC circular-foil spacecraft look like; what will it cost; and where will it go?  
The OTC spacecraft will look very much like what you have been hearing people describe as a flying saucer. The first experimental models will be fairly large, of anywhere from forty to one hundred feet in diameter and will cost millions of dollars, as do the first prototypes of any aircraft.  
But unlike conventional aircraft, the OTC space vehicles will very soon be brought down to family size of about ten-foot diameter, can be built to sell for less than the cost of a modern automobile, and will take your family across town, across

the nation, or around the world in absolute comfort and safety, and in a fraction of the time ever before possible.  
Drawings and specifications for the first OTC circular-foil spacecraft are furnished as part of the literature offered below.  
OTC Enterprises will be ready within the next six months to start licensing manufacturers all over the world to mass-produce the OTC space vehicles in many sizes and styles for every transportation need.

### THE ECONOMY

"How will OTC inventions of free-energy devices affect world economic conditions?" Will they help or will they hurt?  
The introduction, manufacture, and use of OTC free-energy devices will bring more prosperity to more people in the United States and throughout the world than any single invention in the entire history of the world.  
Here's why. Most of the world's problems today have their roots in a hunger for more energy than is available. States and nations are fighting over what is left of ordinary fuels and the available supplies of water to make electricity and irrigate the land.  
You have had many recent examples of our delicate balance of supply and demand in this great country. You've seen the rationing of gasoline and oil. You've seen the lights go dim in the Pacific Northwest. You've seen vast millions of burning desert acres, barren only for lack of a little irrigation. And even now the oil men are beginning to squeeze the last drop out of every ton of shale.  
The power hunger is the same the world over, only more so: the most shocking recent example was the willingness of Egypt to close the Suez Canal and fight the world for a few kilowatts of electricity.

The OTC free energy devices can change all this in a remarkably short space of time. Enough electric power and energy in their right places, and we will have undreamed-of markets for every other kind of goods and materials and appliances our factories and shops can turn out.  
And so goes the simple formula so well demonstrated in these United States: Give the world enough electrical energy, you raise the world's standard of living. Raise the world's standard of living and you raise the world's economy.

This can now for the first time be an absolute promise: with the OTC free-energy devices in whatever quantity may be needed, as fast as they can be manufactured. Thus, OTC Enterprises can only help lift our total economy to vastly higher levels.

### INDUSTRY

Will the OTC Enterprises free-energy devices help or hurt the world's existing business and industry?  
OTC's President Otis T. Carr answers that one quickly and a little sharply: "Our primary interest," says Mr. Carr, "is the opportunity of all industry the world over, to have an ownership with us in our business."  
Mr. Carr explains his exact meaning by pointing out that OTC Enterprises will not mass-manufacture anything. OTC and its subsidiaries will design basic models known as prototypes, which will then be turned over to other manufacturers to build in quantity.  
Thus, as Mr. Edison's electric light is being made and sold by thousands of concerns the world over, Mr. Carr's Utron engines and Carrotto gravity motors will be made and sold by many thousands of concerns and for every conceivable power and mechanical purpose.

OTC Enterprises is even now able to demonstrate in miniature form, the ways in which these electrical and mechanical devices will be able to furnish power for automobiles, trains, great ocean liners and space ships, as well as such things as hearing aids, portable television sets, refrigerators, and even furnish light, heat and power for large cities.  
The OTC devices will do all these things, by using the perpetual space-forces of magnetism, gravity, and electro-magnetism—and these forces alone—which are free and available everywhere on the face of the earth and throughout the universe.  
Business and industrial leaders around the world are now being invited to itemize the kinds of free-energy devices their concerns are interested to manufacture.

The best way to get the total concept of what his free-energy devices mean to the world, is to suppose that the wheel were just now being discovered—then consider that OTC Enterprises is putting the wheel into the air . . . in an entirely new dimension. This should be pretty good for industry.

### DEFENSE

Will the OTC free-energy devices be a factor in our national defense?

The answer is an emphatic YES! The discoveries and inventions of Otis T. Carr can without question be the scientific balance of total strategy that will take the free people of the world completely out of any further danger of war for all time to come!  
And may God forbid that an OTC device ever be called on for such a mission.

### EMPLOYMENT

How will the OTC Enterprises activities affect employment? Will the introduction of free-energy devices put people out of work, or will they create new jobs?

These are questions that concern everybody, and especially the management of OTC Enterprises.  
We are able to give you absolute assurance that the introduction of the revolutionary new OTC devices of all kinds will create more and better occupations for all people everywhere who want to work.  
Much of what you have already heard about this exciting new basic industry will automatically indicate the employment opportunities to be created by the OTC developments.  
Much more will become obvious as the corporation grows and spreads its unique inventions into mass-manufacture all around the world.  
The discoveries and inventions of Otis T. Carr truly represent the inception of a basic NEW industry, which for sheer size and scope you might properly compare with the steel industry, the automobile industry, and the aircraft industry combined!  
And that may well be a conservative comparison. It is obvious that as time goes on, and new applications are worked out for the OTC free-energy devices, and more and more of the world's billion-population takes to the air in OTC spacecraft, vast new activities of all kinds will develop and flourish beyond our wildest hopes and dreams.  
As a pioneer in discovery, as a pioneer inventor, as a pioneer in space-flight, OTC Enterprises will be a pioneer in an entirely new concept of employment practices and employee relationships.  
No more than that can be said at this time, but when the OTC Enterprises research institutes are built and operating, it will indeed be an entirely new type of employment opportunity for thousands of people to achieve the greatest heights they are capable to accomplish in a work relationship.

OTC Enterprises sincerely believes that the application of free-energy devices can help supply the needs of all people, and that when these needs are satisfied we will enter into a millennium of Peace and Plenty.  
At the present time, however, as evidence of OTC's willingness and even eagerness to cooperate with the government's program of national and world defense, OTC Enterprises has urged the U. S. Government to order the OTC manned spacecraft and other free-energy devices for maximum use in military preparedness.  
In that respect the OTC free-energy devices can furnish unlimited electric power and mechanical energy for the field, sea, and air forces, to light their lights, run their vehicles, and do their work wherever they want to go in our solar system . . . and without fission or fusion!

This, of course, includes the astonishing development of the OTC circular-foil spacecraft, which can go anywhere in the solar system—either manned or un-manned—and can serve as a transportation vehicle to carry men and supplies, or it can carry any required size of what the military characterizes as a warhead.  
And may God forbid that an OTC device ever be called on for such a mission.

OTC Enterprises will soon begin actual construction of this first group of buildings on a large site at Space, Maryland. This building complex will be completely powered, lighted, and mechanized by the free-energy space forces of gravity and magnetism. It will be the scene of research and development in the further application of free-space energies for worldwide use. Later additions to the installation will include a large spacecraft for the landing of visiting craft and will include hotels, residences, and complete shopping facilities for thousands of employees, their families, and guests.



Otis T. Carr, President  
OTC Enterprises Incorporated  
Pioneering Scientist & Inventor



If you would like to know more about these astonishing new developments, we will send you a complete list of explanatory literature including our 12-page brochure, and other literature in color, a large lithograph conception painting of the OTC circular-foil spacecraft in flight (ready for framing), plus bulletins, folders, pamphlets, specifications, photos & 10 photographs of the spacecraft propulsion system in flight, and other interesting information and data, including the new release of Mr. Carr's book, "Dimensions of Mystery." This book was written in 1952 in codification of the scientific principles and dimensions of mystery alone is priced at \$5.00, but when ordered with the other literature described above, the entire group of material may be had for only \$5.00 postpaid.



## HUGE NEW FREE-ENERGY RESEARCH INSTITUTE TO BE CONSTRUCTED IN BALTIMORE COUNTY

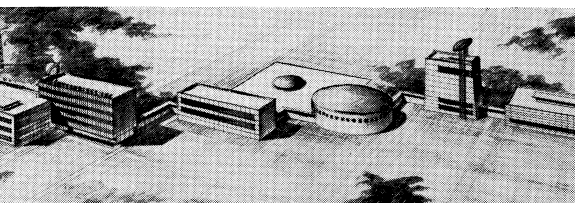

OTC Enterprises will soon begin actual construction of this first group of buildings on a large site at Space, Maryland. This building complex will be completely powered, lighted, and mechanized by the free-energy space forces of gravity and magnetism. It will be the scene of research and development in the further application of free-space energies for worldwide use. Later additions to the installation will include a large spacecraft for the landing of visiting craft and will include hotels, residences, and complete shopping facilities for thousands of employees, their families, and guests.



**OTC ENTERPRISES, INC.**  
UTRON ATOMIC DEVELOPMENT INC.  
CARROTTO DYNAMICS INC.

2502 North Calvert Street, Baltimore 18, Maryland

Trademark of OTC Enterprises Inc.  
© COPYRIGHT 1958 BY OTIS T. CARR, BALTIMORE, MARYLAND.



Patents pending on all designs - (C) Copyright 1958 by Otis T. Carr, Baltimore, Maryland - (R) Trademark Registered by OTC Enterprises - (I) Trademark of OTC Enterprises - The designs and all statements published hereon are the novel and original developments of Otis T. Carr and the OTC Enterprises. They are fully covered by the conventional legal protections of the United States and other countries and may not be reproduced for resale, re-use, exhibition, or for remuneration or gain without specific consent in writing from OTC Enterprises Incorporated.

OUTER FRAME CONSTRUCTION

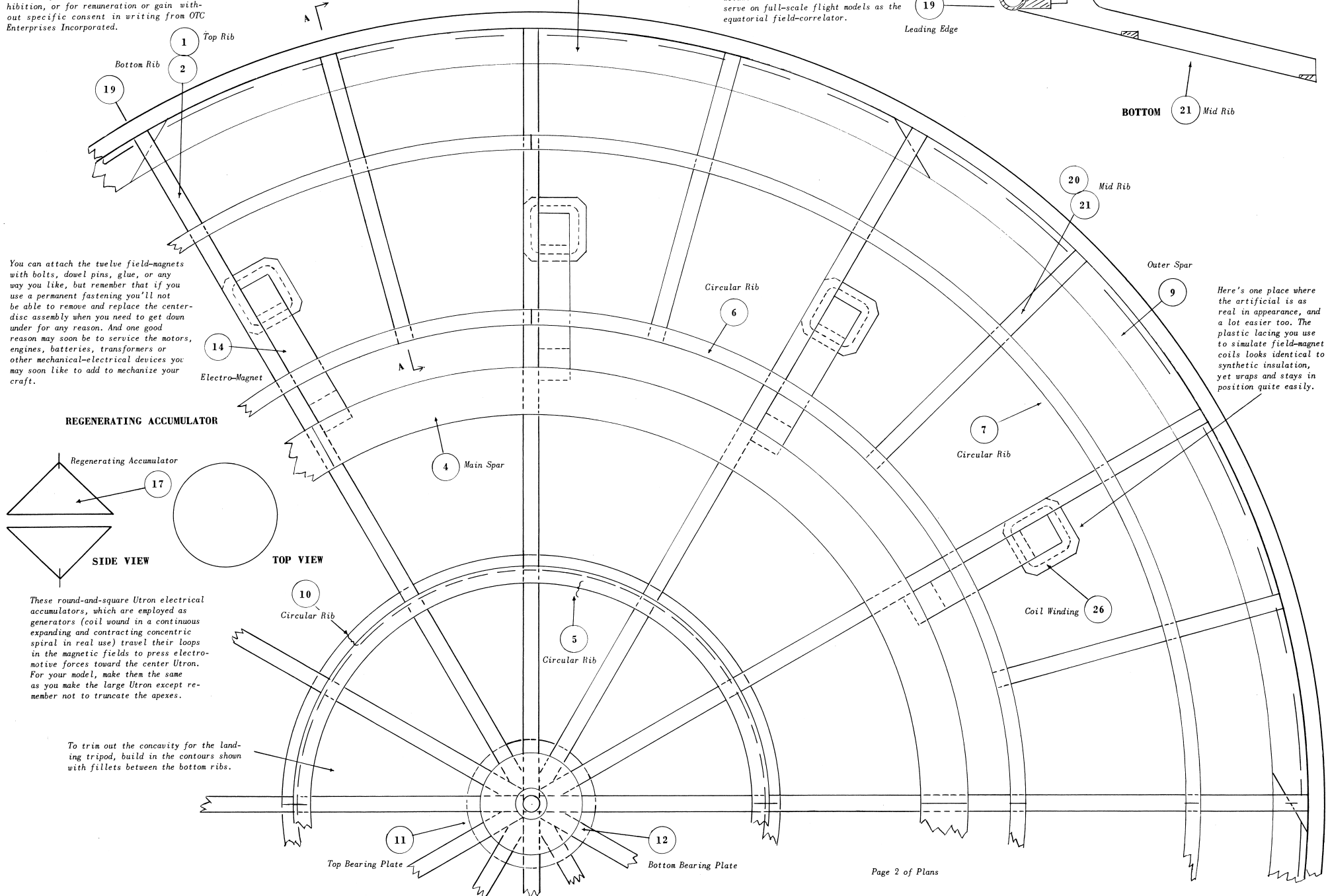

You can laugh if you want, but it seems more than coincidence that the Hula Hoop came into wide favor at the exact right time to help you complete your model OTC-XI. So happens that these styrene hoops very closely simulate the actual dielectric material that will serve on full-scale flight models as the equatorial field-correlator.

You can attach the twelve field-magnets with bolts, dowel pins, glue, or any way you like, but remember that if you use a permanent fastening you'll not be able to remove and replace the center-disc assembly when you need to get down under for any reason. And one good reason may soon be to service the motors, engines, batteries, transformers or other mechanical-electrical devices you may soon like to add to mechanize your craft.

Here's one place where the artificial is as real in appearance, and a lot easier too. The plastic lacing you use to simulate field-magnet coils looks identical to synthetic insulation, yet wraps and stays in position quite easily.

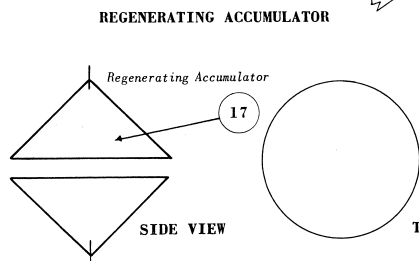

These round-and-square Utron electrical accumulators, which are employed as generators (coil wound in a continuous expanding and contracting concentric spiral in real use) travel their loops in the magnetic fields to press electro-motive forces toward the center Utron. For your model, make them the same as you make the large Utron except remember not to truncate the apexes.

To trim out the concavity for the landing tripod, build in the contours shown with fillets between the bottom ribs.



**CARR'S PRINCIPLES OF FREE-ENERGY SPACE FLIGHT ACCORDED**

**Highest Scientific Verification**

Otis T. Carr, President of OTC Enterprises in Baltimore and inventor of a manned space craft, which he has offered to build and deliver to the government without one penny of risk to the American taxpayer, publicly revealed the propulsion principle of his space craft in the following statement.

"Any vehicle accelerated to an axis rotation relative to its attractive inertial mass, immediately becomes activated by free-space-energy and acts as an independent force." An excellent example of this principle applied in practice is the fact that the two satellites now orbiting the earth, have achieved space-energy activation by an equivalent inertial velocity, and where it not for their susceptibility to internal or inherent physical deterioration, they would theoretically and factually be kept orbiting by natural space forces until the end of time in our solar system. These statements in evaluation of natural physical phenomena as first discerned and made public by Mr. Carr, have been physically tested in laboratory experiment by an impartial scientific laboratory and confirmed as follows: "We have shown that a charged body, accelerated to an axis rotation relative to its attractive inertial mass, indicates polarity in a given direction. The dip-needle points, say, up toward the top of the body. But mount this whole rotating body, with its spindle, on another platform and rotate this platform on a spindle, then, if the counter-rotation is greater than the initial forward rotation of the body, a dip-needle on the second platform will point down while the first dip-needle points up, indicating the complete relativity of polarity. When the exact counter-rotation matches the forward rotation the body loses its polarity entirely and immediately becomes activated by free-energy (tensor stresses in space) and acts as an independent force."

"Your discovery therefore is distinctly a possibility, and its creative genius lies in its inventor's ability to provide it with a process for generating its own power as a result of its self-rotation."

Translated into familiar terms, this scientific explanation means that the above described assembly of counter-rotating charged masses becomes weightless and will escape the immediately attractive gravitational forces.

**"BEWARE THE INVENTOR"**

(From a Boston Newspaper Published in 1873)

"A man about 46 years of age, giving the name of Joshua Coppersmith, has been arrested in New York for attempting to extort funds from ignorant and superstitious people by exhibiting a device which he says will convey the human voice any distance over metallic wires, so it will be heard by the listener at the other end. He calls the instrument a telephone, which is obviously intended to imitate the word telegraph and win the confidence of those who know of the success of the latter instrument without understanding the principles on which it is based.



**OTC ENTERPRISES, INC.**  
 2502 NORTH CALVERT STREET • BALTIMORE 18, MARYLAND • TUXEDO 9-4900  
 CARROTTO® DYNAMICS INC., AND UTRON® ATOMIC DEVELOPMENT INC.

CABLE CODE: MILLENNIUM

To Major Wayne S. Aho  
 GREETINGS:  
 We are pleased to accept your booking of passage on our first scheduled flight to the terrestrial Moon on 7 December 1959, and return on 15 December 1959.

The OTC-X1 Spacecraft will depart Space, Maryland promptly at 0001 on the above date, will orbit the Planet Earth in expanding concentric spirals for approximately three hours (Earth-time reference), and will land on the Moon at 0500 hours. The return trip will be accomplished during Earth's first ebb-tide on the 15th.

The purpose of this flight is to enable you to plant the flag of the United States Of America on the Moon, along with the banner of Universal Brotherhood. During its seven-day duration we will also observe and report conditions on all lunar surfaces from the Moon's first-quarter phase on 7 December to its full-phase on 15 December.

Please keep us informed of your whereabouts in the intervening period from now until departure time, as we shall need to instruct you on the several aspects of preparation for flight, and custom fit a thermal-exchange circulatory system that you will wear in transit.

Your selection from among many applicants, as the sole honorary passenger in addition to the OTC-X1 crew to make this first flight, was decided upon as a signal honor in recognition of your outstanding record of altruistic endeavors in the field of communication for Universal Enlightenment and Interplanetary Fellowship.

Further in this respect, all costs of your passage will be borne by OTC Enterprises as our salute to your pioneering leadership and self-sacrifice in your activities for the uplift and higher evolution of all mankind.

  
 Norman E. Colton  
 FLIGHT ENGINEER  
 at Space, Maryland

  
 Otis T. Carr,  
 FLIGHT CAPTAIN

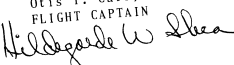
  
 Hildegard W. Shea  
 FLIGHT COMMISSAR

**FLIGHT PLAN OF THE OTC-X1 ON OPERATION MOON**

Takeoff at 12:01 a.m. 7 December 1959.

The craft will depart from Space, Maryland in a vertical rise and beginning orbit of the earth at a speed of 5000 mph. The first orbit will take the craft to the ionosphere. The second orbit will take the craft in and through the ionosphere at a velocity of 18,000 mph. On its third orbit the velocity will be increased to 25,000 mph and the craft will accelerate and fall toward the moon at 76,000 mph. Five hours after takeoff the OTC-X1, will be orbiting the moon. The OTC-X1, which will carry three passengers, will explore space in the vicinity of the moon and return on the seventh day.

OTIS T. CARR

**CLAIMS CHRIST DISCLOSED TRUE NATURE OF UNIVERSE IN SYMBOLISM OF CROSS**

Visionary Mr. Carr claims that Christ disclosed the true nature of the Universe in the Symbolism of the Cross. He pointed out that "Christ is truly expressed in the sign of the Cross...the true Cross...the absolute...the finite expression of the cosmos that we call the Universe." The inventor further stated:

"A universe has only two basic properties; the motions and the directions. The correlation of these properties manifest in several forms, their two categories being called energy and matter.

"These two forms are equal to each other, and are the product of each other, matter being energy under the pressure of motion and having relative finity because of the harmonious correlation of the direction of such pressure, and energy being matter released from pressure by any change in the direction of motion.

"In any universal system, these motions and directions manifest their finite totality in what we call space, and describe their total form in what we call straight lines and curves, the geometry of which is expressed in a finite form whose dimensions are a constant correlation of the directions and motions. We have equated the shape of this universal space and translated it into physical form which we have called the Utron Electrical Accumulator, which expresses the linear correlation of space motions and directions in a form that is therefore completely round & completely square.

"In its linear proportions the Utron Electrical Accumulator is the union of straight lines brought together in and from all directions, and in its correlation of and with curved lines it expands from a point to the circumference of its equator and contracts from that equator to a point, always being a correlation of complete curves. The aim of these linear correlative dimensions is three points, the exact center point of which is +0 and -0, the exact peripheral points of which are +X and -X.

The space ship designer then mathematically points out his theory-

$$\frac{-0}{+0} = 0, \frac{-X}{+X} = X, 0+X = 0X$$

Continued Mr. Carr:

"We were inspired to complete this work in the service of the Christ Jesus by Albert Einstein's search for a unified field. This relativity in a unified field, expressed in physical form is the square in the circle bisected by the Cross. The Utron Electrical Accumulator is the full expression of the dot that was the beginning of 0X, extended in all directions to form the cross, which in motion continues on to form the square and the circle...

"in the Beginning, was the WORD. The WORD was 0X, and in the revelation of Jesus, was given for all who wanted to see, in the symbolism of the true cross.

"Set the cross in motion and you will see the halo that is LIGHT and which we also call ENERGY.

"If there is no time  
 And there is no space  
 There can be no other place.  
 If there is no near  
 And there is no far  
 Perhaps the Universe  
 Is right where we are."

Concluded Mr. Carr:

"Man's oneness with God in His Universe is inseparable."

Norman E. Colton, sales engineer for the OTC Enterprises, summed it up this way:

"You will find it all in the Bible or the High school physics books.

"It's the true Easter Message. It's the Unified Field Equation.

"It's the courageous basis for the unity of principle that can bring Science and Religion together if they'll face up to it.

"If you can find one authority who can disprove any of its statements I'll be his disciple."

FROM : : : OTC ENTERPRISES  
 TO : : : ALL NEWS MEDIA  
 FOR : : : IMMEDIATE RELEASE

23 January 1958

Once in a while we find the big news in what is NOT said... When Russia launched the sputnik satellite#2 and said it weighed more than one-thousand pounds, the free world was astonished and dismayed because even to this day, many weeks later, we do not know how they got the heavy device into space, and do not ourselves, have the ability to duplicate the Russian accomplishment.

Even more surprising--not one scientist or military expert has come forward with even a suggestion as to HOW THE RUSSIAN'S BIG HEAVY SATELLITE GOT UP THERE!!

That is, not one except Mr. Otis T. Carr of Baltimore, Maryland. Mr. Carr, you'll remember as the inventor of the OTC-circular-foil spacecraft he recently offered to build for the U. S. Government with no money down and twenty-million dollars COD on delivery.

Mr. Carr immediately came out with a statement way back in November, saying he thought the Russian's had launched their heavy satellite with an electro-magnetic device similar to a giant trench-mortar. Yesterday a Russian General was quoted in these words:

"... the rocket is fired through a radio beam or electro-magnetic gun barrel," and that the method explained could be applied to a rocket carrying a satellite.

Here's what Mr. Otis T. Carr said two months ago: "The Soviet has constructed a device to power its space vehicles that would operate on the basic principle of the mortar-type launcher, in which the vehicles would be propelled by the ionization of their component materials, and would be given some initial impetus through the use of their great cyclotron as a form of electro-magnetic induction coil.



CENTRAL ROTATING ASSEMBLY

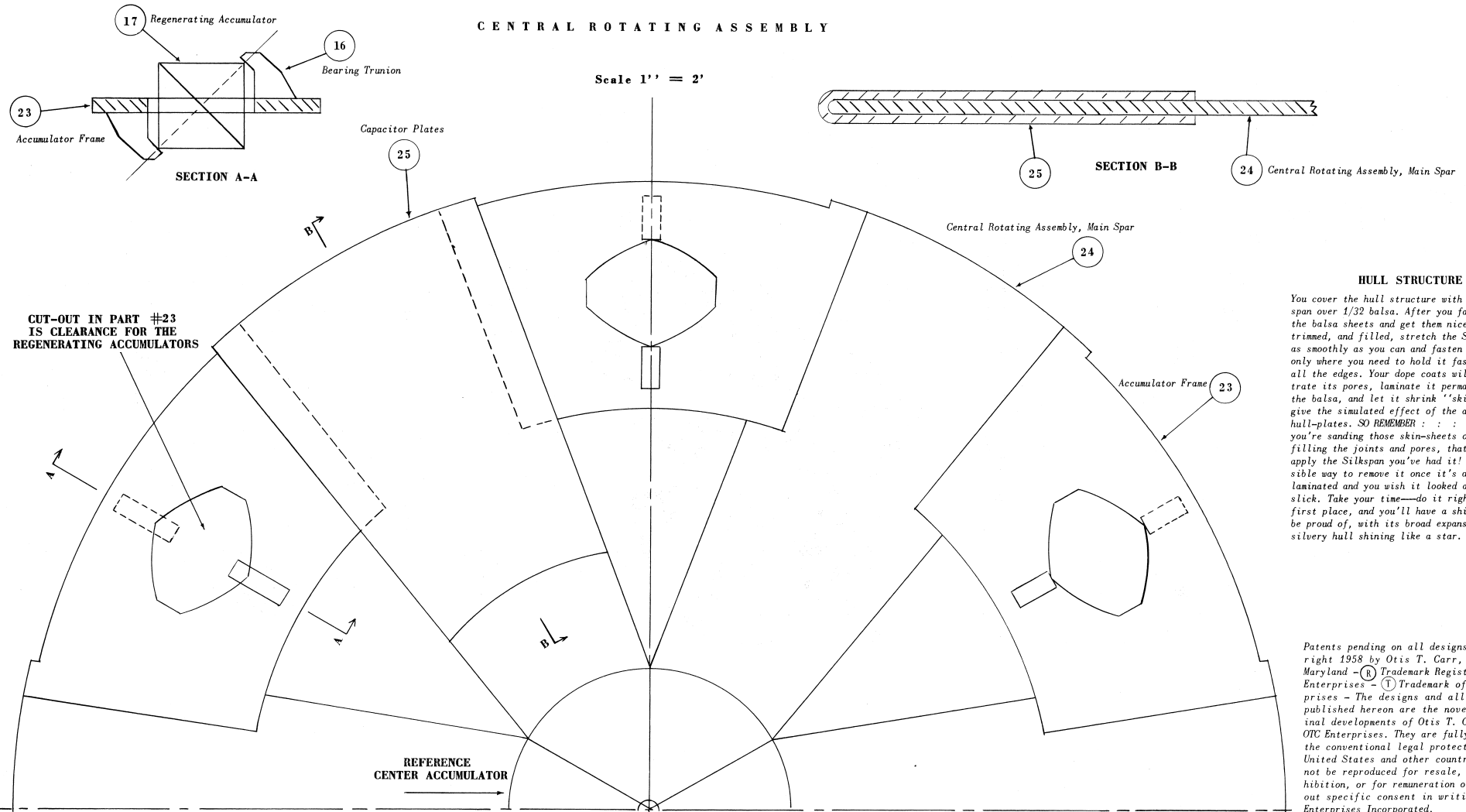

HULL STRUCTURE

You cover the hull structure with the Silkspan over 1/32 balsa. After you fasten the balsa sheets and get them nicely smoothed, trimmed, and filled, stretch the Silkspan as smoothly as you can and fasten it with glue only where you need to hold it fast around all the edges. Your dope coats will then penetrate its pores, laminate it permanently to the balsa, and let it shrink "skin-tight" to give the simulated effect of the actual metal hull-plates. SO REMEMBER : : : when you're sanding those skin-sheets of balsa and filling the joints and pores, that once you apply the Silkspan you've had it! No possible way to remove it once it's doped and laminated and you wish it looked a bit more slick. Take your time—do it right in the first place, and you'll have a ship-shape to be proud of, with its broad expanse of silvery hull shining like a star.

Patents pending on all designs - © Copyright 1958 by Otis T. Carr, Baltimore, Maryland - ® Trademark Registered by OTC Enterprises - ® Trademark of OTC Enterprises - The designs and all statements published hereon are the novel and original developments of Otis T. Carr and the OTC Enterprises. They are fully covered by the conventional legal protections of the United States and other countries and may not be reproduced for resale, re-use, exhibition, or for remuneration or gain without specific consent in writing from OTC Enterprises Incorporated.

CENTRIPETAL EQUILIBRATOR

This is an accessory to help you demonstrate the inner workings of your OTC-XI Spacecraft and teach your family and friends the principles employed in all its inherent assemblies. It is not itself an inherent part of either your model or of the actual passenger-carrying craft. You snap it into place by light-pressured force-fit when you need it will be obvious when you get your craft built and assembled. The hull's two bearing supports on the center shaft are only established when the upper-hull assembly is interlocked into place with the lower section. When the upper hull is removed the lower will be inclined to wobble because it has only the one bearing support. If anyone should give it a careless spin it would probably break some of the magnets or generator trunnions. The equilibrator is your ounce of prevention.

You'll want to make a tiny mating-mark on the outside of each hull assembly as a convenient reference point for putting the two together where they're intended to go each time you assemble them. LIKE SO. . .



LINEAR CORRELATOR

First time you ever saw such a ruler? Very likely so. As far as anyone's been able to find out up to now, the zero-center ruler is the original design shown here for the first time by Otis T. Carr. While it has some very deep technical significance in linear correlation and space-time relativity, it is also a very useful and practical measuring stick that minimizes the probability of compounding inaccuracies. Numerically, your one-and-one still makes two, plus the advantage in template-making, for example, of automatic centering and measuring all linear forms equidistant from a center. Make yourself one in wood or metal and you'll find the more you use it the more you'll like it.

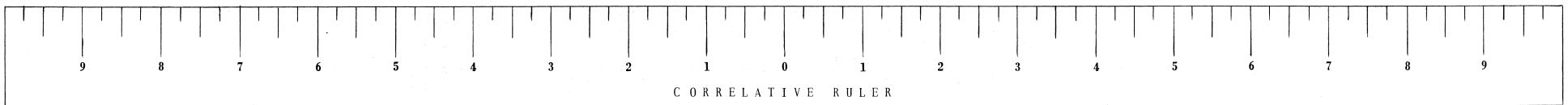



**WHO QUALIFIES?**

**And What Does The Offering Circular Mean When It Says  
"Even Fly It Yourself (Under Proper Qualification)"**

It won't be too long before OTC-X1 Spacecraft and their offspring will be riding the airplanes and Spacelanes all over this earth and throughout our solar system.

It won't be too long before people like you and the boy next-door will be piloting, fixing, and navigating practical electrified flight models on scheduled runs between cities on the several planets we know of, or even the several billion we've yet to discover.

And it won't be long before the OTC energy systems are as familiar and plentiful as Mr. Tesla's AC motors.

Then why are we holding back the several sheets of plans that reveal the exact workings and wirings, the circuitry and controls, and the internal cellular constructions of the accumulators and generators that would show you exactly how to energize and fly a facsimile miniature using real space forces?

Well, start with conventional aircraft. Ask yourself what the conditions would be under which you would build and fly one of your own with no outside supervision, training, or licensing. Or even an activated model of one?

The answers are obvious. The average private individual wouldn't dream of attempting such a thing. Nor would we think of cutting even a small power-model loose into the airplanes because we automatically realize what a hazard it would be to craft already in the air under intelligent guidance.

It begins to be obvious then, that it will take training, education, supervision, authorization, and most of all the proper and adequate facilities for qualified construction and handling of OTC-X1 Spacecraft that will operate on their own built-in power systems and levitate their way around the cosmogeneous force-fields.

All this is more important and more critical when you consider that the Utron power-packages, which motivate our OTC Spacecraft and other energy systems, are able to develop controllable forces of Atomic magnitude. And naturally, in untrained hands or in under-equipped laboratories, such forces let loose could cause real havoc.

OTC wants you to learn, train, and qualify. OTC wants you to prepare to enter and join the Interplanetary Space Age, enjoy its benefits, and share its abundant blessings. And OTC will help you in every way possible.

We are now, and will be continually preparing explanatory technical literature, lesson-plans, study courses, and we will have lecturers touring the world's schools, colleges, and institutions with travelling exhibits to help one and all get into high gear for space-age activities.

But since this is for tomorrow, who in the world qualifies today, and what must they know and need to start with the program right here and now?

One good example would be people already engaged in aircraft production or the making of energy machines of older kinds.

Others would be mature professional people at all levels and in all categories of laboratory research and development in our institutions and industries.

And you are next!

Fill out the inclosed questionnaire; let us know which way you want to go.

We'll help in every way we can.

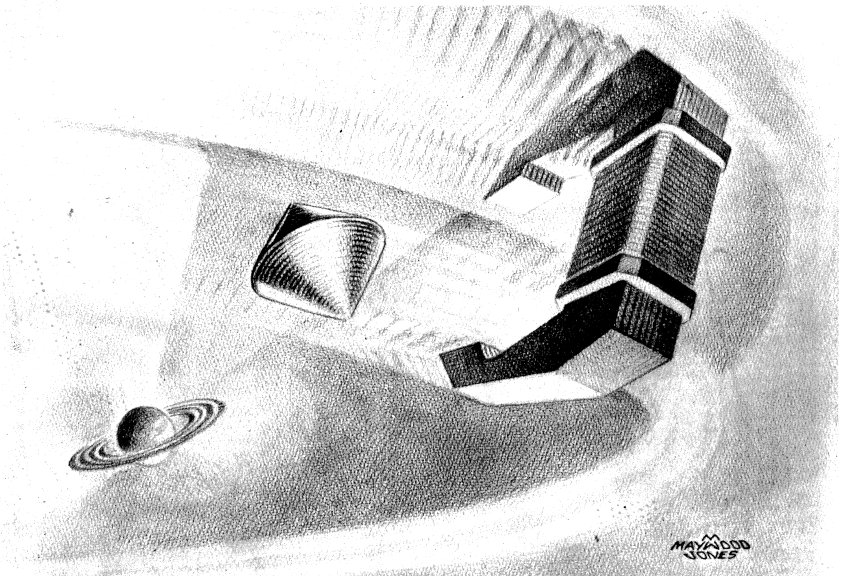

**SPACEFORMS IN MOTION OF PRESSURE**

"The dimensions of pressure are straight line; the dimension of motion is a curvature. Pressure creates motion and motion creates pressure. Therefore, motion is dimensionally fourth."

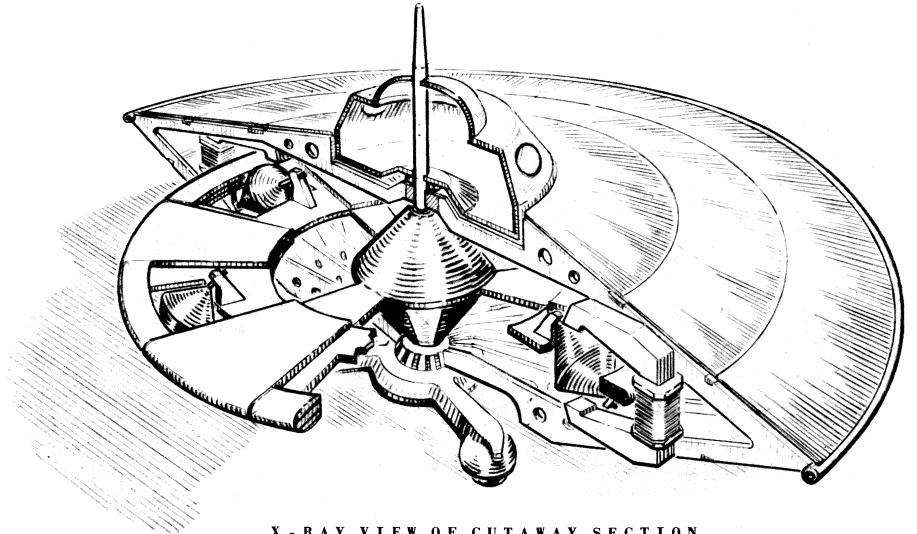

**X - RAY VIEW OF CUTAWAY SECTION**

This view through the hull, from the outermost to the innermost, lets you see every component unit in assembled relationships.

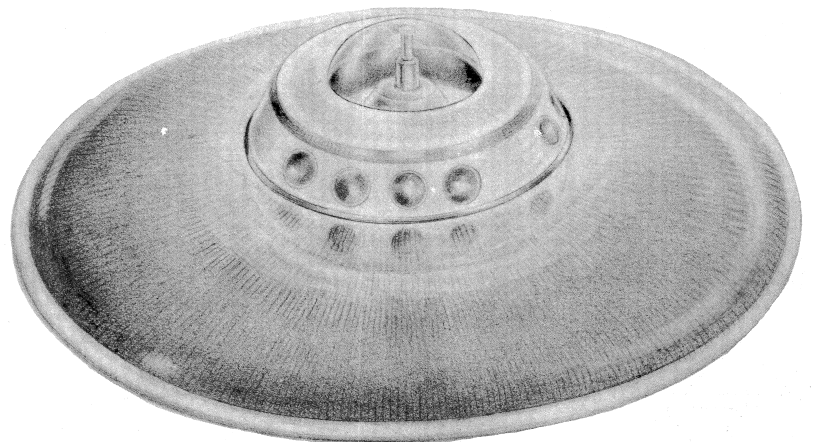

**EVOLUTION OF RUMOR INTO FACT**

Flight-conception rendering of your model OTC-X1 by artist Jones shows astonishing similarity to "saucers" from other planets.



Patents pending on all designs - © Copyright 1958 by Otis T. Carr, Baltimore, Maryland - ® Trademark Registered by OTC Enterprises - ® Trademark of OTC Enterprises - The designs and all statements published hereon are the novel and original developments of Otis T. Carr and the OTC Enterprises. They are fully covered by the conventional legal protections of the United States and other countries and may not be reproduced for resale, re-use, exhibition, or for remuneration or gain without specific consent in writing from OTC Enterprises Incorporated.



To save hard labor and still have a strong landing tripod, make the trunnions in three sections of clear white pine and join them with Weldwood glue.

Whether you paint them in or cut them out, do the portholes last, after the entire cabin is assembled and base-coated.

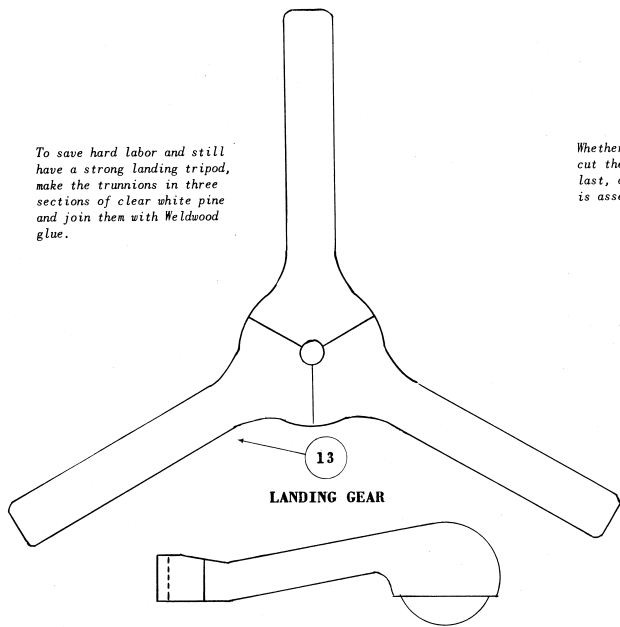

13  
LANDING GEAR

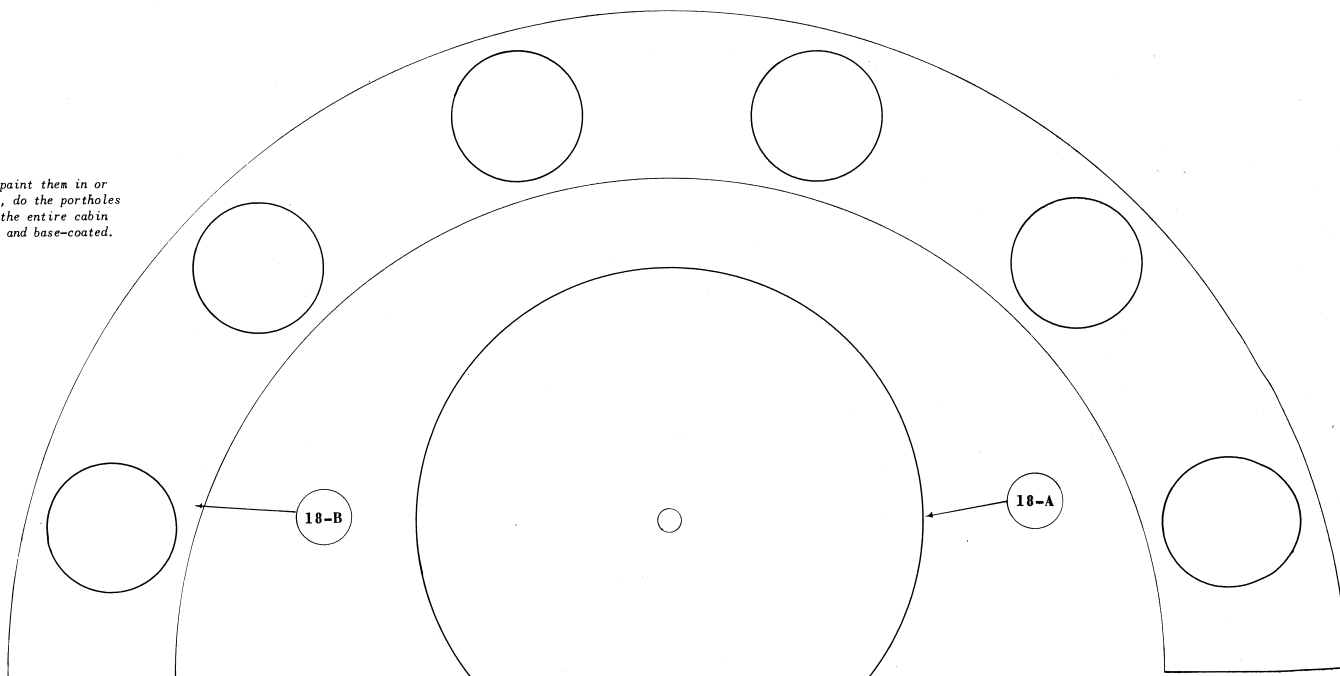

EXPLODED VIEW OF CABIN ASSEMBLY

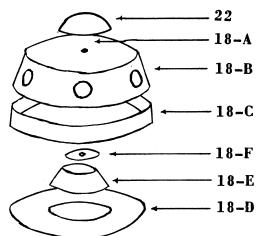

CABIN DETAIL

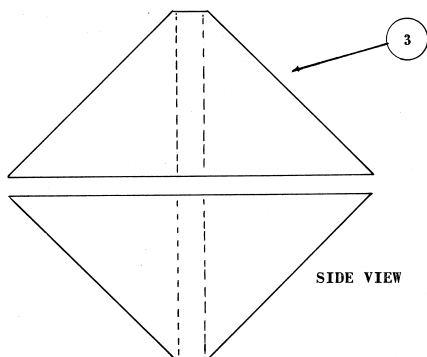
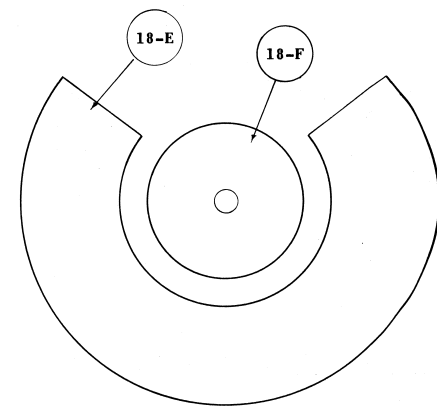
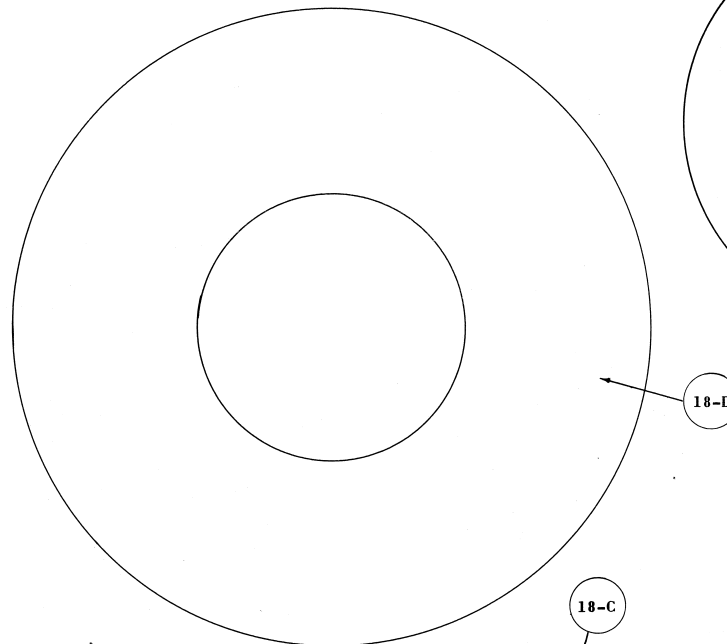

SIDE VIEW

CENTER ACCUMULATOR

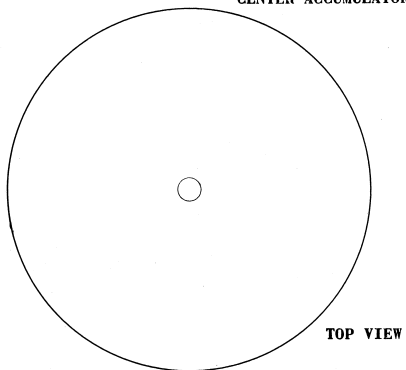

TOP VIEW

While you can if you like fashion the Utron accumulator out of one block, you'll find it easier to make two conical sections. Position the two (right-angle) cones top and bottom on the rotating center-disc assembly per the cross-section detail on pages 1 and 2. The cones can either be turned (if you're a lathe owner), or whittled and sanded from a block, or cut and shaped from full-round stock.

Patents pending on all designs - © Copyright 1958 by Otis T. Carr, Baltimore, Maryland - ® Trademark Registered by OTC Enterprises - ® Trademark of OTC Enterprises - The designs and all statements published hereon are the novel and original developments of Otis T. Carr and the OTC Enterprises. They are fully covered by the conventional legal protections of the United States and other countries and may not be reproduced for resale, re-use, exhibition, or for remuneration or gain without specific consent in writing from OTC Enterprises Incorporated.