

Juan D. Lopez

magnetic amplifiers

magnetic amplifiers

principles and applications

by PAUL MALI

*Instructor in Electrical and Mathematical Technology,
and Director of Education and Training,
Electric Boat Div., General Dynamics Corp.*



John F. Rider Publisher, Inc., NEW YORK

Copyright August 1960 by John F. Rider Publisher, Inc.

**All rights reserved. This book or any parts thereof may
not be reproduced in any form or in any language
without permission of the publisher.**

Library of Congress Catalog Number 60-12440

Printed in the United States of America

PREFACE

CUSTOMISED
61268562

This book was written because of a need to make available fundamental concepts of magnetic amplifiers. It is intended primarily for technical aides, electronic technicians, electrical draftsmen, electricians, and students, interested in a fundamental knowledge of the operation and applications of magnetic amplifiers. It also serves as a review for electrical engineers who have long been away from the electrical field. Engineers and designers are given a quick introduction to the language and circuits associated with magnetic amplifiers, before attempting the more intricate concepts and difficult circuits.

The basic principles and laws governing the operation and uses of magnetic amplifiers are presented along with application in diverse industrial systems. Extensive mathematics and detailed circuitry have been limited for a simpler and more fundamental presentation, to be easily assimilated.

The author wishes to gratefully acknowledge the efforts of David Anderson, staff assistant to the senior vice president of operations of General Dynamics Corp., New York, who has made the publishing of this book possible. Thomas Pugarelli of the State Technical Institute, Hartford, Conn., must be mentioned for recognition in submitting valuable comments and criticisms. Additionally, the author wishes to acknowledge the valuable assistance of the following people of the Electric Boat Div. of General Dynamics Corp., William Sardelli, Donald Bowers, Frank Kohanski and Dianne M. Donch.

The author wishes to thank the organizations who have granted permission to make reference to their systems in the section on applications. These are: Westinghouse Electric Corp., Minneapolis-Honeywell Regulator Co., and The Louis Allis Co.

Recognition should also be given to my wife, Mary, for her unceasing efforts in keeping two well-meaning children from making unplanned "physical" revisions of this manuscript.

PAUL MALI

*August, 1960
Groton, Conn.*

CONTENTS

Introduction	1
Magnetism	3
Electromagnetism	11
Magnetic Circuits	23
The Saturable Reactor	26
Self-Saturating Types	34
Three-Legged Core Magnetic Amplifiers	39
Compensating Magnetic Amplifiers	42
Polarized Magnetic Amplifiers	46
Amplifier Gain	50
Feedback	53
General Uses and Construction	56
Maintenance and Troubleshooting	68
System Applications	72
Glossary	96
Index	99

Magnetic amplifiers were developed as early as 1885 in the United States. At that time they were known as *saturable reactors* and were used primarily in electrical machinery and in theater lighting (Fig. 1).

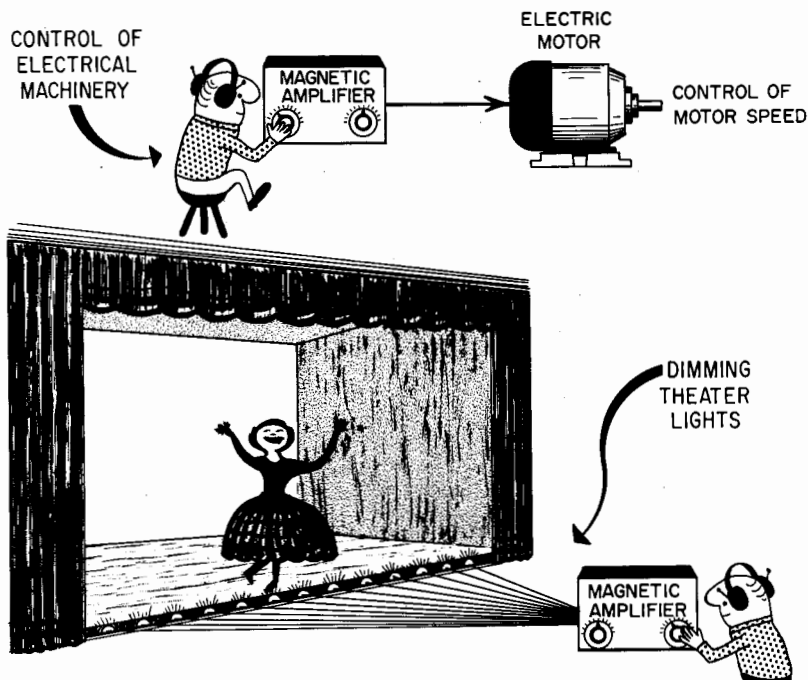

Fig. 1. Early saturable reactors were used for control of motor speed and dimming theater lights.

Overshadowed by the advent of vacuum tubes, the uses of magnetic amplifiers were limited until World War II. During the Battle of Britain, when the Germans were firing long-range rockets at major British cities, a group of British engineers and scientists pieced together the shattered fragments of one of these rockets that failed to explode. One component of this rocket was a magnetic amplifier, used to regulate the frequency output of an a-c generator. The remarkable discovery was that this component of only a few pounds, had no vacuum tubes or moving parts. Investigation later showed that this device was one of the results of a German development program started early in World War II.

It is interesting to note that the Germans published very few internal reports on magnetic amplifier development, either during or following the war. No basic theoretical disclosures were made by German scientists, since their development was conducted more on a trial-and-error basis (Figs. 2 and 3).

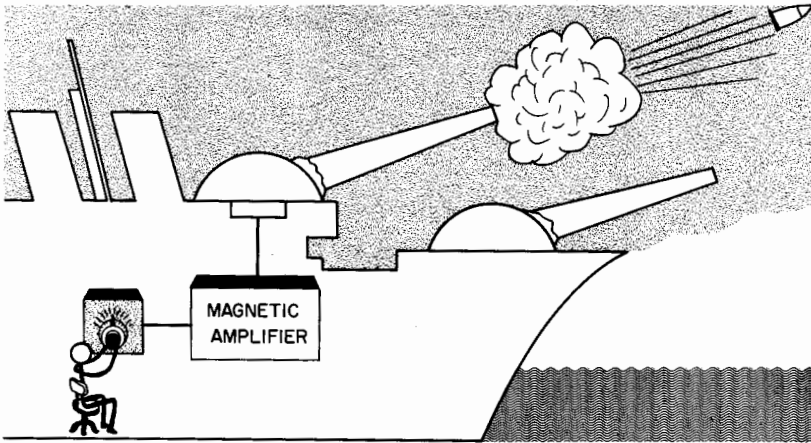

Fig. 2. The German navy used the magnetic amplifier in fire control systems.

The fact that the Germans introduced the device into fields previously dominated by electron tubes is considered by many to be as great a contribution as the technical development of the device.

Although Germany is unquestionably responsible for the rebirth of the magnetic amplifier, other countries, especially the United States, held a considerably greater number of patents on it. The efforts of Sweden, England, and Japan were also considerable. It was during World War II that the U. S. Navy started to exploit the device for purposes other than power regulators.

The increased research and development contracts throughout the country today reveal an increased demand in the use of this remarkable device

MAGNETIC AMPLIFIERS WERE USED...

...TO LEVEL AIRCRAFT

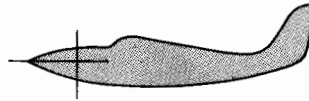

...TO PITCH AIRCRAFT

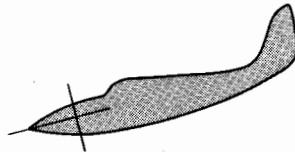

...TO ROLL AIRCRAFT

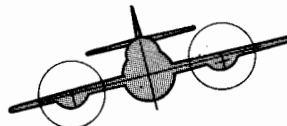

Fig. 3. The German air force used the magnetic amplifier in control systems for aircraft.

in many electrical systems. It can be truly said in considering its potential worth and use in the electrical field, that the magnetic amplifier is still growing to full maturity.

MAGNETISM

An understanding of the operating principles of magnetic amplifiers requires a knowledge of magnetism, electromagnetism, and magnetic circuits. Thorough mastering of these basic concepts will give the reader an easy understanding of the operation of magnetic amplifiers and their use in electrical systems.

Nature of Magnetism

The ancients were familiar with a natural stone that would attract bits of iron. It was a form of iron ore, now known as *magnetite*, and the power of attraction possessed by it was called *magnetism*. It was later learned that other material (such as nickel, cobalt, and iron alloys) could possess this peculiar property by an artificial means of using an electric current. Over the years, our knowledge of the exact nature of magnetism has improved; but it is still incomplete. Laws concerning magnetic properties of materials were observed and learned as these materials were used under practical conditions. Today, the use of magnetism and the laws of its behavior are vital and necessary parts of the field of electricity.

Types of Magnetic Material

Any material which can be made to possess this peculiar property of holding bits of iron is called a magnetic material, and exhibits the properties of a magnet. This magnet is said to possess polarity by virtue of its two poles — a North Pole (North-seeking) on one end, and a South Pole (South-seeking) on the other end.

The amount of magnetism possessed by different materials varies. If a material can be strongly magnetized (possessing a great deal of magnetism) it is classified as *ferromagnetic*. If a material can only be slightly magnetized (possessing a small amount of magnetism) it is classified as *paramagnetic*. If a material cannot be magnetized (possesses no magnetism) it is classified as non-magnetic (Fig. 4). Most magnetic materials are paramagnetic, such as chromium, aluminum, and zinc. Very few magnetic materials are ferromagnetic, such as iron, steel, nickel, and their alloys.

Magnets may be classified as permanent magnets, temporary magnets, or electromagnets. A hard steel bar (when magnetized) becomes a tempo-

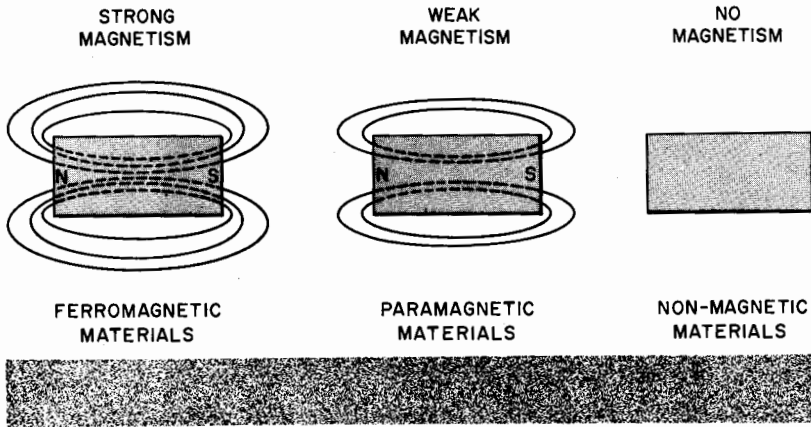

Fig. 4. Magnetized and nonmagnetic materials.

rary magnet, since it loses its magnetism within a short period of time. Any magnetic material whose magnetism can be strengthened or weakened by an electric current is called an *electromagnet*.

Modern Theory of Magnetism

All materials are composed of atoms whose structure resembles our own solar system. Electrons revolve around a nucleus in well-defined paths, as planets revolve around the sun. These paths or orbits are many, each containing electrons not only revolving around the nucleus, but also spinning on their own axes. Because of these movements, tiny magnetic fields exist between the electron and the nucleus, as well as around the electron, with North and South Poles established.

The modern theory of magnetism is that no matter how many electrons there are in each ring or orbit, the direction of the spins (clockwise or counterclockwise) varies, so that within one atom some of the electrons

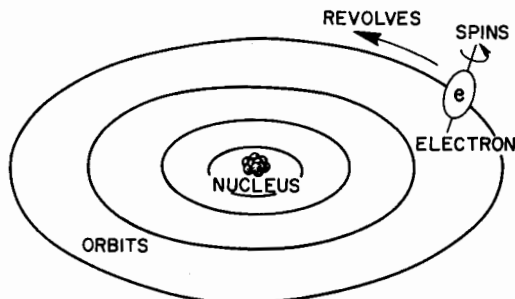

Fig. 5. Electron revolving around nucleus and spinning on its axis.

are spinning in a clockwise direction, and the remaining spin, counter-clockwise (Fig. 5). This would indicate that an atom may contain an excess of spins in a certain direction or a deficiency of spins or a balanced number of spins. Even though each electron has a tiny magnetic field with a North and a South Pole, a collection or group of these electrons spinning in the same direction, would add their fields to create a greater magnetic field. Materials having atoms whose number of electron spins are unbalanced, are considered to be magnetic materials. Those materials having a balanced number of spins are nonmagnetic.

If the tiny magnetic field of a spinning electron lines up (alignment of poles) with other fields within the atom, and this one atom aligns itself with other atoms to form a group, this aligned group of atoms is called a *domain*.

The domains of magnetic materials are considered as tiny magnets with direction (North and South Poles). These domains are arranged in a haphazard or random fashion within the material when it is demagnetized. An illustration of this is shown in Fig. 6, with the arrows representing and

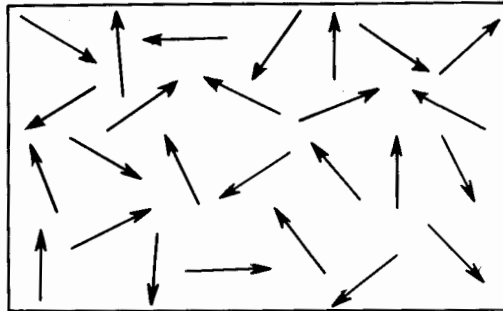
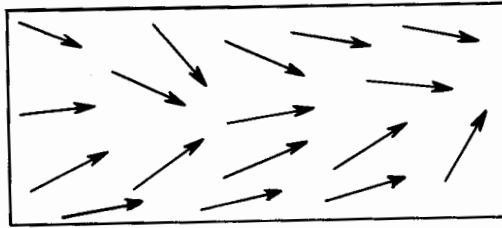

Fig. 6. Domains in an unmagnetized material.

showing the direction of the domain. When an external force is capable of causing these tiny magnets to align or orient themselves so that they are pointing in the same direction, the magnetic material is said to be magnetized (Fig. 7A).

Fig. 7B shows all the domains oriented in one direction. Any attempt by an external force to improve on this alignment would be useless since all the domains are already aligned and pointing in one direction. The magnetic material is said to be *saturated*, and it would have its maximum magnetic strength. Magnetic materials require varying amounts and different types of external means to cause maximum alignment of these domains. This also means that the degree of magnetic strength of materials can be varied by varying the alignment or orientation of these domains which act as tiny magnets.

MAGNETIC AMPLIFIERS



(A)

Fig. 7A. Domains in a slightly magnetized material.

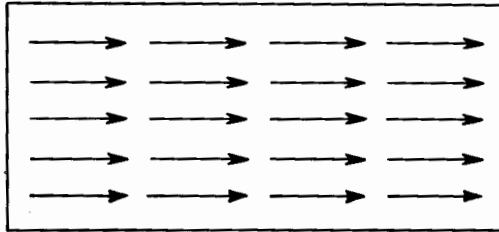

(B)

Fig. 7B. Domains in a strongly magnetized material.

Alignment of domains	Degree of magnetization	Degree of saturation
Haphazard and randomly aligned	No magnetism	Unsaturated
Partially aligned	Minimum magnetism	Slightly saturated
Maximum alignment	Maximum magnetism	Saturated

Lines of Force (Magnetic Flux)

Iron filings sprinkled on a piece of cardboard placed on top of a magnet, arrange themselves in a definite pattern (Fig. 8). This pattern indicates the influence the magnet exerts in the space surrounding the magnet. This influence is attributed to what is called lines of force, since a definite force is exerted on objects placed in it. This influencing area surrounding the magnet is called a *magnetic field*.

The production of these lines of force in a magnet is attributed to the collective effects of the lines of force of the tiny domain magnets within the structure of magnetic materials. The lines of force within a magnetic

Fig. 8. Magnetic lines of force around a bar magnet.

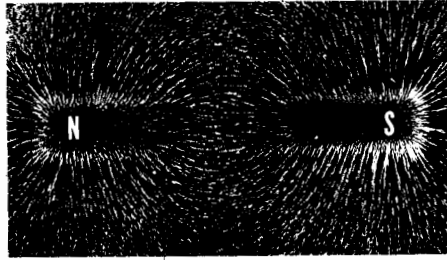

field is often referred to as *lines of flux*, or simply *flux*. They are often designated by the symbol " ϕ ". The unit of flux is one line and is called the *maxwell*. The flux per unit area, or the number of maxwells, is known as the *flux density* and is designated "B". The unit of flux density, or one maxwell per square centimeter, is called *gauss*. Therefore, by definition:

$$\text{Flux density (B)} = \frac{\text{Total flux } (\phi)}{\text{Area (A)}}$$

Example: Evaluate the flux density of a toroid having a cross-sectional area of 3 square centimeters and a total flux of 6,000 lines (maxwells). Solution: A toroid is a doughnut-shaped magnetic material with a circular cross-section (Fig. 9).

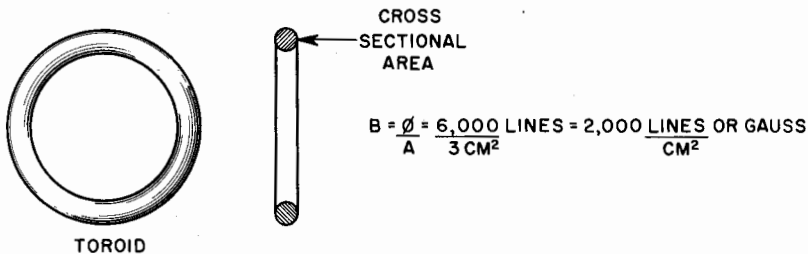

TOROID

Fig. 9. A toroid is a doughnut-shaped material with a circular cross-section.

Properties of Lines of Force or Flux Lines

Flux lines, or lines of force, are continuous, and always form closed loops. They can be cut or broken by moving objects, but they immediately mend or complete their loops after the objects pass through the field; they are never left open or broken.

Flux lines have direction, as shown by the arrows in Fig. 10. They emerge from the North Pole, go through the air, and enter the South Pole to return through the magnet.

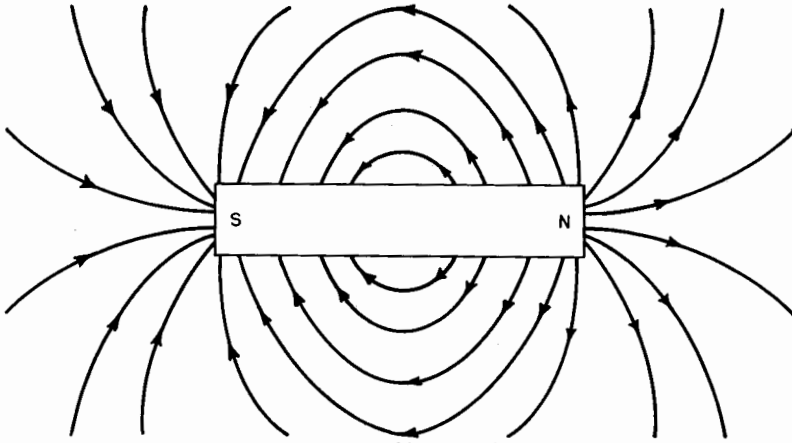

Fig. 10. Magnetic field around bar magnet.

Flux lines never cross each other. They can be bunched, crowded, or thinned out over a large area. When they are bunched or crowded, each flux line has a repelling effect upon its neighboring flux line. This tends to keep them separated from one another. The concentration of flux lines in and around the poles is greater than away from the poles. Flux density, therefore, is greatest in the region of the poles, and least in the regions away from the poles.

A flux line has tension. It can be stretched or constricted along the direction of the lines of force. This tension is somewhat like a stretched rubber band that tends to become as short as possible.

Flux lines pass through all materials. There is no insulator for magnetic lines of force. Since materials vary in their composition they offer different amounts of resistance. Hence, flux lines tend to take the path of least resistance, preferring iron or steel to air or gas.

Laws of Magnetism

If the North Pole of a magnet is placed within the magnetic field of the North Pole of another magnet, or if the South Pole is placed within the magnetic field of another South Pole, forces of repulsion will exist. If the North Pole of a magnet is placed within the magnetic field of a South Pole, or if a South Pole is placed within the magnetic field of another North Pole, a mutual attraction between poles will exist.

The amount of attractive or repulsive force that these poles exert depends upon the strength of the magnet's field and the distance or location of the objects being affected.

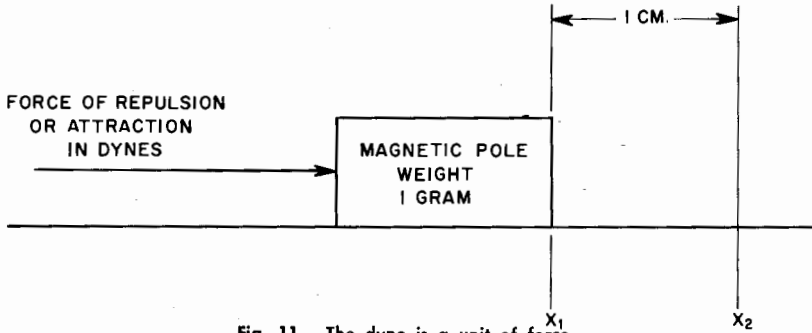

Fig. 11. The dyne is a unit of force.

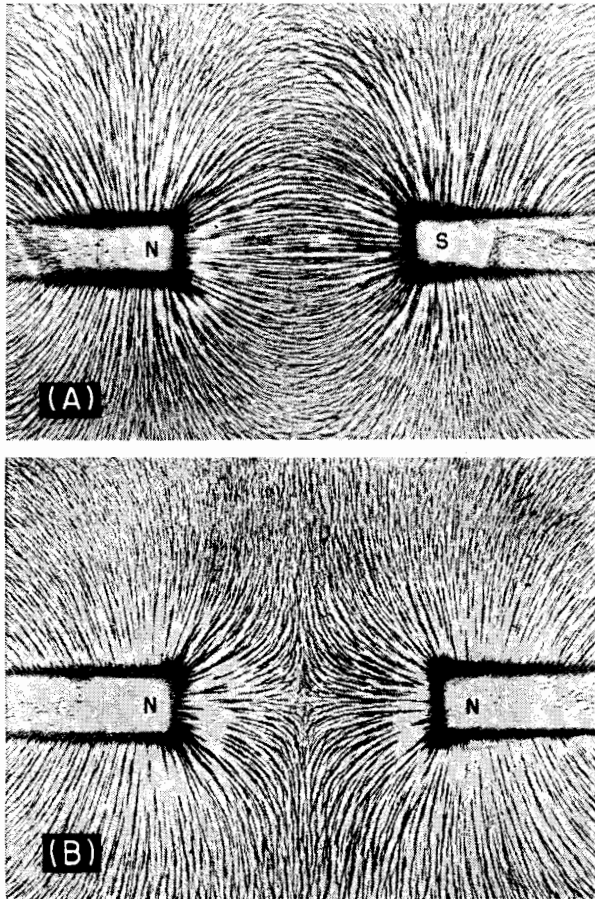

Fig. 12. Pattern of magnetic flux lines.

$$\text{Force (F)} = \frac{\text{Pole strength (M}_1) \times \text{Pole strength (M}_2)}{(\text{Distance between poles})^2 \text{ or } (d^2)}$$

Force (F) equals attractive or repulsive force between poles expressed in units of dynes. $M_1 M_2$ equal the unit of magnetic poles expressing the strength of the magnet; and defined as one which, when placed 1 cm from an equal and similar pole in vacuum or air, repels it with a force of 1 dyne.

What a Dyne Is

The dyne is the unit of *force* in the Metric System, and when it acts on a weight of 1 gm, this force causes the weight to accelerate at the rate of 1 cm/sec/sec. The pole moves from position X_1 to position X_2 at a rate of 1 cm/sec in the time interval of 1 sec. (See Fig. 11.)

Fig. 12 illustrates the pattern the magnetic flux lines take for two different conditions: Unlike poles attracting and like poles repelling. Example: Two North-pointing poles of strength 10 and 20 units, respectively, are 5 centimeters apart in air. Determine the type of force between the poles, the direction of the force, and the magnitude of the force. For the solution, see Fig. 13. (Note: The nature of the medium that contains the lines of flux plays an important role in the computation. It will be described in a later section on permeability.)

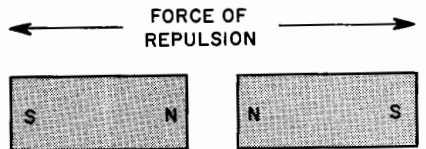

$$\text{FORCE} = \frac{M_1 M_2}{D^2} = \frac{10 \times 20}{2^2} = \frac{200}{4} = 50 \text{ DYNES}$$

Fig. 13. Solution to example given.

Review Questions

1. What has been accomplished in the field of electricity as a result of our understanding of the laws of magnetism?
2. Explain the reasons for different degrees of magnetic strength possessed by different materials.
3. If a coil is to be wound around a toroid core to produce 12,600 lines within the core with a flux density of 6,300 lines per square centimeter, what is the circumference of the coil?
4. Two magnetic poles, North and South, are facing each other 20 centimeters apart with strengths of 15 and 25 units respectively. Determine the type of force between the poles, direction and magnitude of the force.

Magnetic Field Around a Conductor

If a straight vertical conductor carrying an electric current pierces a cardboard (Fig. 14), the plane of the cardboard will contain lines of flux which illustrate the principle: *Current-carrying conductors produce magnetic fields around conductors.*

Fig. 14. Concentric field around a conductor.

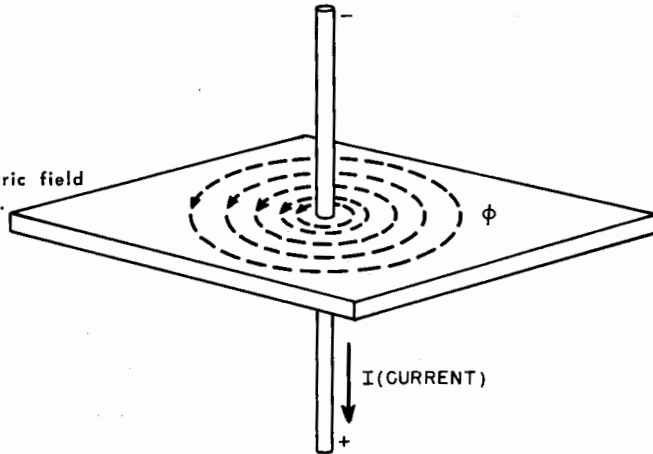

To determine the direction of a magnetic field around a conductor, grasp the conductor with the left hand, pointing the thumb in the direction of current flow. The fingers will then point in the direction of the magnetic field.

When a conductor is bent to form a loop (Fig. 15) the closed flux loops are no longer circular. They become more crowded in the space inside the loop of wire, and less crowded in the space outside the loop of wire. Accordingly, the intensity of the magnetic field within the loop has increased since there is a denser field within the loop. When several loops of a conductor are placed together to form a coil (Fig. 16), the intensity of the magnetic field is multiplied by the number of turns of wire. The value of the field intensity at any point for two turns would be twice that for a single loop; for three turns, three times that for a single loop. A large number of turns of the conductor produces a large magnetic field.

Fig. 16 shows how each individual loop produces a field and contributes to the overall magnetic field of the coil. In the upper conductors of the coil, the current flows toward the reader (dot) and produces a clockwise magnetic field. Since all upper conductors produce magnetic fields in the same direction, the individual fields combine to form a field in one direc-

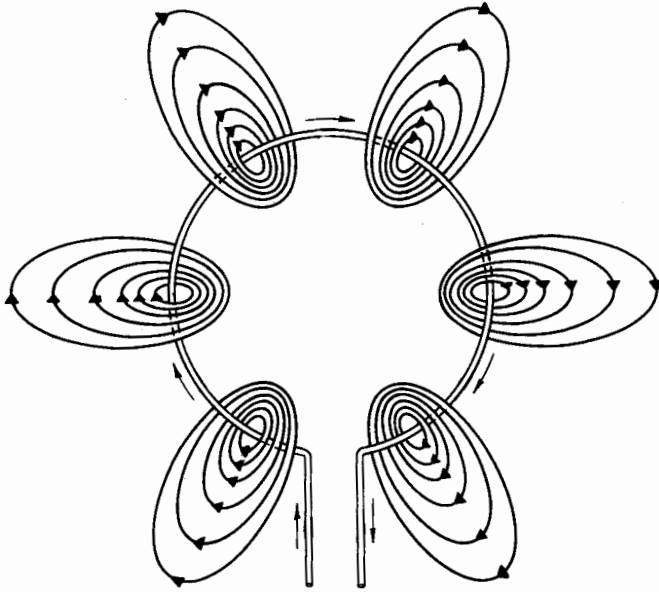

Fig. 15. Magnetic field around current-carrying loop.

tion. In lower conductors of the coil, the current flows away from the reader (cross) and produces a counterclockwise magnetic field. Each individual conductor field — since it is in the same direction — combines to form a continuous field. This coil of wire, due to looping many conductors in helix fashion, creates an overall magnetic field similar to that of a bar magnet with North and South Poles (Fig. 17).

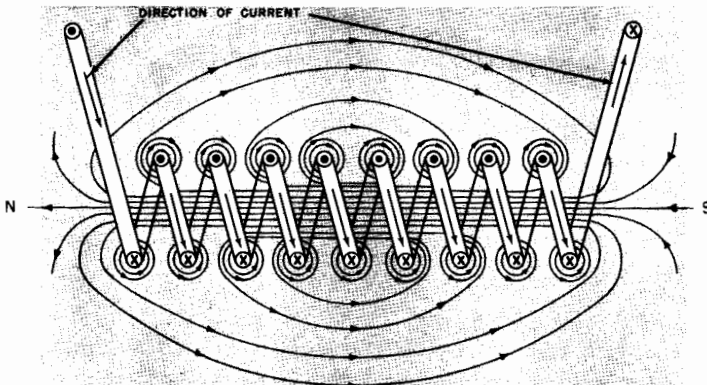

Fig. 16. Cross-sectional-view of a coil carrying a current.

When a piece of soft iron is inserted within the coil, the intense magnetic field (instead of passing through air) passes through a material of less resistance. This *increases* the number of lines of flux formed to close the circuit between the North and South Poles.

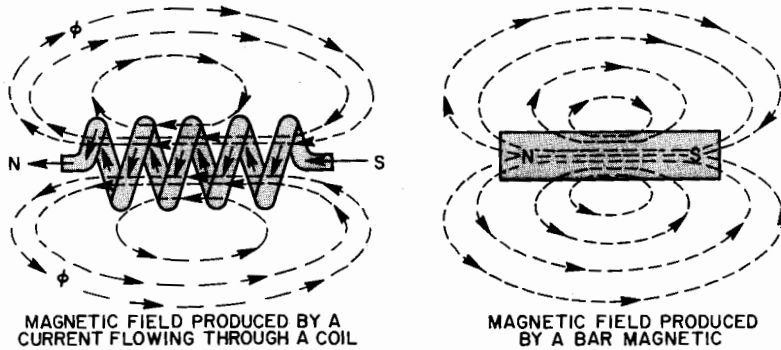

Fig. 17. Magnetic fields.

Magnetomotive Force (\mathcal{F})

To cause flux to flow in a particular material, a force is necessary. It is called *magnetomotive force*. It is a measure of the strength of a source which produces lines of force or lines of flux. Magnetomotive force is often referred to as the ampere-turns of a coil, since it is the product of the number of turns of the coil and the current flowing through the coil. The symbol used for this force is mmf.

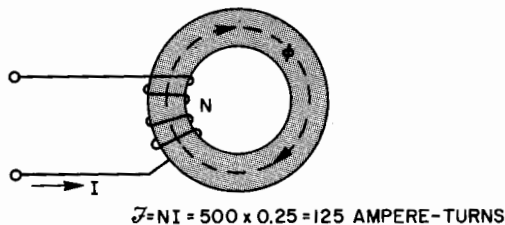

Fig. 18. Solution for example.

$$\text{Force } (\mathcal{F}) = \text{Ampere } (I) \times \text{Number of turns of coil } (N)$$

Example: Determine the mmf of a coil wound on a toroid, when 0.25 ampere is flowing through the coil of 500 turns. Solution: Fig. 18.

Magnetizing Force or Magnetic Intensity (H)

If we increase the amount of current flowing through a coil, we find that the intensity of the field is increased proportionately. Therefore, magnetic field intensity (H) is related to an electric current for any given set of conditions. The field intensity in the air on the inside of a coil can be found by using the following equation:

$$H = 1.26 \frac{NI}{l}$$

Where: N equals the total number of turns; I equals the current flowing through the coil; l equals the length of the coil in centimeters; 1.26 equals the constant of the coil. The field intensity (H) can be considered as the force tending to produce magnetic flux in each unit length of a magnetic circuit, and is often referred to as the magnetizing force. Substituting magnetomotive force in the above mentioned equation:

$$H = \frac{F}{l} \text{ or } F = Hl$$

Permeability

The measure of the magnetic conductivity of a substance is known as its permeability, and is indicated by the Greek letter μ . It indicates the relative ease by which a material will permit magnetic flux to pass through it. By definition, the permeability of any magnetic material can be expressed as:

$$\text{Permeability } (\mu) = \frac{\text{Flux density (B)}}{\text{Magnetizing force (H)}}$$

Permeability compares the relative ease of a substance in conducting flux lines with air (air being standard). For example, a given coil with a known current produces 1,000 lines of flux when air is its core. With a change in core material, the coil will produce, 6,000 lines of flux. This indicates that the core material is capable of conducting magnetic flux six times as great as air. (Its permeability is 6.) Air is used as a reference medium and has a permeability of 1. Ferromagnetic materials have high permeabilities; paramagnetic materials have low permeabilities.

Reluctance

Reluctance is the resistance or opposition a material offers lines of flux in a portion or entire magnetic circuit. The amount of reluctance depends upon the type of material and the physical dimensions of the material.

$$\text{Reluctance } (\mathcal{R}) = \frac{\text{Length (l)}}{\text{Permeability } (\mu) \times \text{Area (A)}}$$

If we substitute $\mu = \frac{B}{H}$ in the above equation and simplify:

$$\mathcal{R} = \frac{1}{\left(\frac{B}{H}\right) A} = \frac{Hl}{BA}$$

Substituting magnetomotive force $\mathcal{F} = Hl$ and Flux $\phi = BA$, we have

$$R = \frac{\mathcal{R}}{\phi}$$

The reluctance of a material would depend upon the ratio of magnetic potential drop (mmf) to the flux in any part of a magnetic circuit. Example: A certain toroid has a winding of 300 turns. When this winding carries a current of 5 amps, 50,000 maxwells of flux are produced. Determine the permeability of the toroid core if the mean length is 12 cm and the cross-sectional area is 0.5 cm² (Fig. 19). Reluctance must first be determined:

$$\text{Reluctance } (\mathcal{R}) = \frac{\text{mmf } (\mathcal{F})}{\text{Flux } (\phi)} = \frac{N \times I}{\phi} = \frac{300 \times 5}{50,000} = \frac{1500}{50,000} = .03$$

$$\text{Rearranging } \mathcal{R} = \frac{l}{\mu A} \text{ to solve for permeability } (\mu)$$

$$\text{Permeability } (\mu) = \frac{\text{Length } (l)}{\text{Reluctance } (\mathcal{R}) \times \text{Area } (A)} = \frac{12}{(.03) (.5)} = 800$$

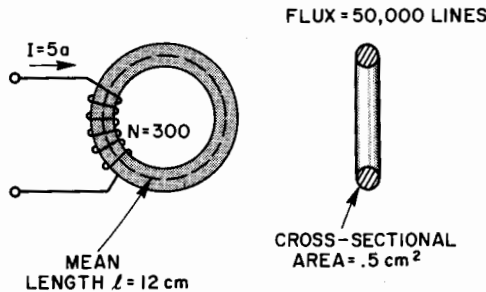

Fig. 19. Solution for example.

Magnetization (B-H) Curves

The amount of flux lines (B) in a magnetic material depends upon the magnetic conducting ability of the material (μ) and the amount of magnetizing force (H). The effect of any change in magnetizing force on the flux density within the material can be observed by a B-H curve or magnetization curve of the material (Fig. 20).

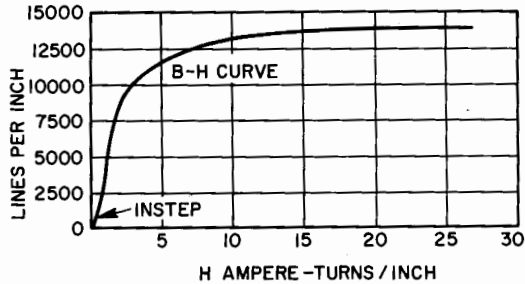

Fig. 20. B-H curve for iron.

The amount of magnetizing force is indicated horizontally (abscissa) from zero to higher values, and the flux density is indicated vertically (ordinate) from zero to higher values. It can be seen from the curve that at very low values of magnetizing force (0-2) the flux density increases at a very low rate (up to instep). This is due to the initial inertia possessed by the domains within the material, and the energy required to overcome this inertia. In the region of 2-4 ampere-turns per inch, the curve is almost linear, indicating that the domains are now responding by orienting in a particular direction at a nearly linear rate. Beyond 5 ampere-turns per inch, the rate of increase of flux drops off until a point is finally reached—no matter how great the magnetizing force—the amount of flux lines the magnetic material is capable of holding, has reached a maximum. The magnetic material is said to have maximum magnetism or be *saturated*. The domains of the material have completed their alignment and are all pointing in the same direction.

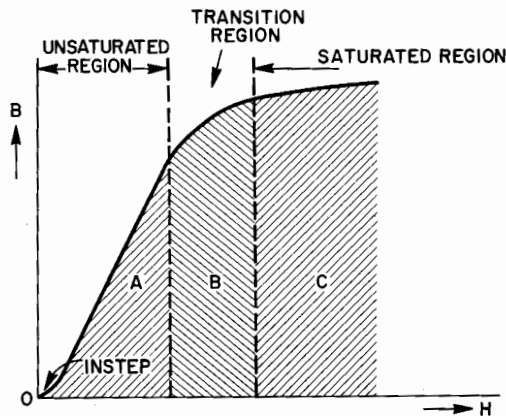

Fig. 21. Regions of the magnetization curve.

The magnetization curve differs in shape and characteristics with different materials. Some would have large slopes, others small slopes. Some would saturate with a small amount of magnetizing force, others would require a large amount of magnetizing force to saturate the material. A magnetization curve would depend upon the following. (1) Type of material: Cast iron, wrought iron, steel, or alloy of these with other materials; (2) Degree of purity: The amount of non-metals or other impurities within the material; (3) Heat treatment: Preparation of the material in annealing processes, temperature of heat, and length of time at that temperature; (4) Degree of radiation exposure: The intensity of neutron flux on gamma rays has an influence on certain materials; (5) Previous magnetic history: Whether or not the material has been subjected to a high degree of magnetization in the past.

The magnetization curve can be divided into three operating regions as in Fig. 21: Region A (unsaturated region), increasing values of magnetizing force (H) causes flux density (B) to increase very rapidly; Region B (transition region), core tending toward saturation despite increasing values of magnetizing force (H), flux density (B) increases slowly; Region C (saturation region), large values of magnetizing force (H) result in little or no flux density change (B) within the core.

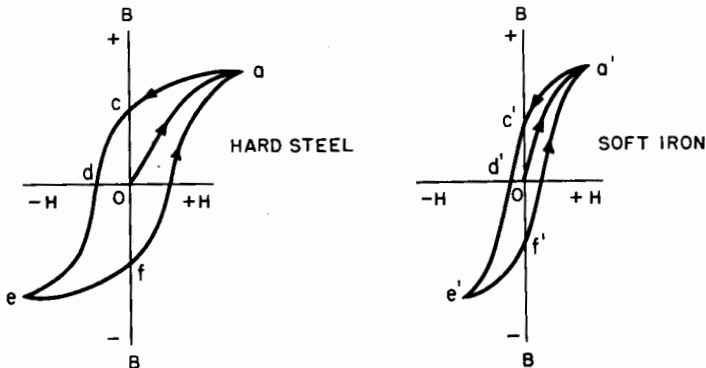

Fig. 22. Hysteresis loops for soft iron and steel.

Hysteresis

Hysteresis is a Greek word meaning to lag. Hysteresis in a magnetic material means the magnetic flux or lines of force lag behind the magnetizing force that causes them. When a magnetic material is subjected to an increasing magnetizing force until the saturation point is reached, and then the magnetizing force is decreased to zero and established in the opposite direction until the saturation point is again reached (and if the magnetizing force is again decreased to zero and again increased until the cycle is

completed), the relations between flux density and field intensity for all parts of the cycle may be represented by a curve (Fig. 22) called the *hysteresis loop*. Note that the lines of force lag behind the magnetizing force that cause them. The hysteresis loop for any given material (Fig. 23) rep-

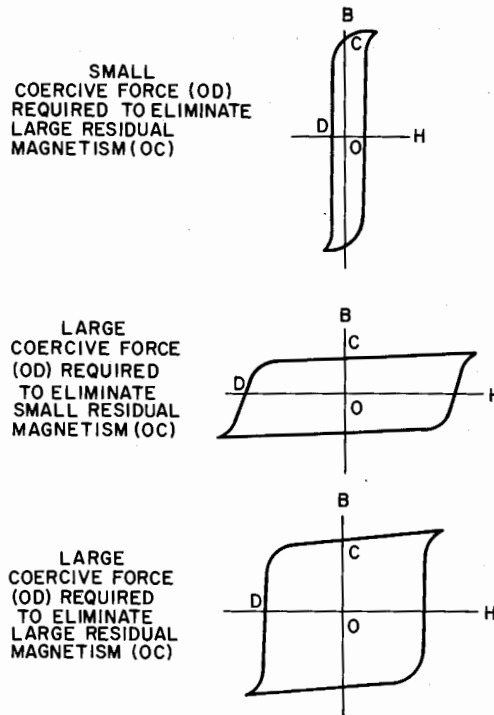

Fig. 23. Types of hysteresis loops for different magnetic materials.

resents the flux density variation produced by one complete cycle of alternating current. The characteristics of these loops are as follows. (1) Points a and a^1 : Positive saturation levels with increasing positive magnetizing force. (2) Points e and e^1 : Negative saturation levels with increasing negative magnetizing force. (3) OC and OC^1 : Positive residual magnetism in the cores. The magnetic material has the ability of retaining its magnetism despite the removal of the magnetizing force. (Note that hard steel is capable of retaining a larger amount of flux density than soft iron.) (4) od and od^1 : Coercive force. This is the amount of magnetizing force necessary to reduce the residual magnetism to zero, or the amount of force necessary to clear the material of all its flux. (5) of and of^1 : Nega-

tive residual magnetism produced by the negative cycle of an alternating current. (6) Areas within the loop: Represent the power losses per cycle of magnetization of the iron core.

Electromagnetic Induction

Michael Faraday, about 1831, experimented and tested the effect of a magnetic field upon a conductor moving through the field. He also tried the opposite condition of moving a field through a stationary conductor. By these methods, he determined that an electromotive force was induced in the conductor. The current caused to flow in the conductor by the induced emf is called an *induced current*. The process in which an emf is induced in a conductor when it is cut by a magnetic field, is called *electromagnetic induction*. The factors affecting the amount of emf are: (1) Number of turns of the conductor when made into a coil; (2) Speed by which the conductor cuts the field or the field cuts the conductor on a per unit time basis; (3) Strength of the magnetic field; (4) The angle or physical relation between magnetic field and conductor.

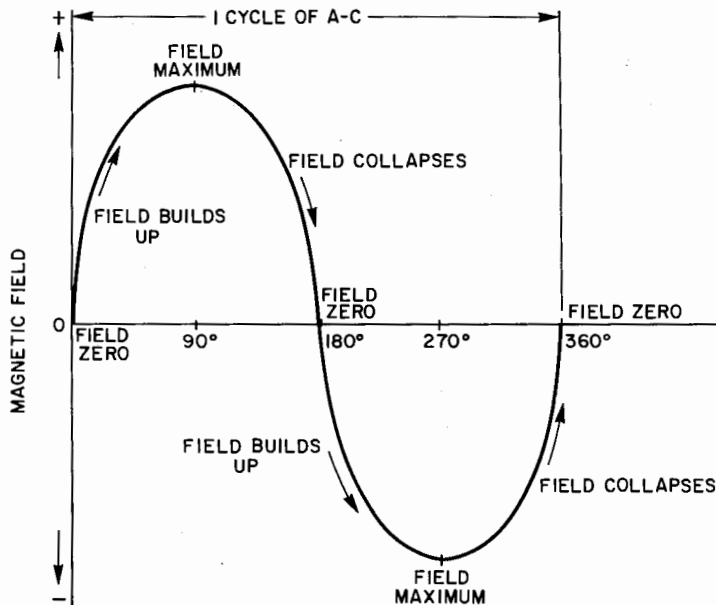

Fig. 24. Changes in the magnetic field from an alternating current.

All of these factors are brought together in Faraday's famous *Laws of Induction*: "Whenever the number of lines of flux threading through a coil is changed, an emf is induced in that coil. The amount of emf induced is proportional to the rate at which the number of lines of force through

the coil is changing." If current i in a coil is a steady-state current (does not change), a field is produced which is also steady-state. However, when the alternating i changes in magnitude with time (represented as di/dt), such as in a-c current when it alternates directions 60 times per second, the magnetic field ϕ builds up, expands in a positive direction, then collapses; builds up, expands in a negative direction, then collapses, and does this 60 times per second (Fig. 24).

Faraday's Laws, may be expressed in the equations following:

$$(1) e = L \frac{di}{dt} \text{ and } (2) e = N \frac{d\phi}{dt}$$

Where N equals Number of turns of wire; L equals Inductance in henries; e equals induced back voltage emf; $d\phi/dt$ equals change in flux with time; di/dt equals change in current with time.

Setting equations 1 and 2 equal to each other and solving for L , we have:

$$L \frac{di}{dt} = N \frac{d\phi}{dt} \text{ and } L di = N d\phi \text{ and } L = N \frac{d\phi}{di}$$

The constant of the coil (L) is called inductance, and is a function of the number of turns of the coil and the rate of change of magnetic flux with respect to current. It is also that property of a circuit which causes an emf to be induced as a change in circuit current occurs.

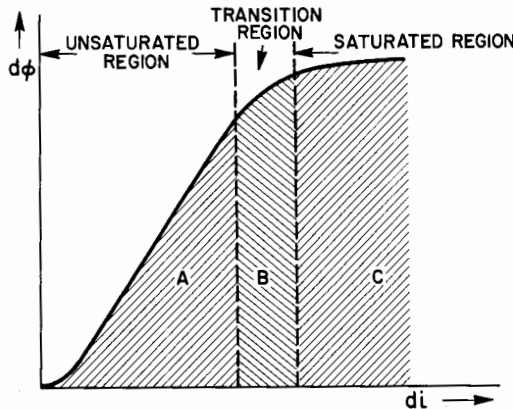

Fig. 25. Magnetization effects on inductance.

Induction and the Magnetization Curve

As described earlier, the magnetization curve is a graphic representation of the relationship between magnetizing force (H) and flux density (B) in a magnetic material. Also described was the effect of operating in various

regions of the curve with changes in magnetizing force on nonsaturation. Operation in various parts of the magnetization curve also has a significant effect on the inductance of a coil wound around the magnetic core material.

Since inductance has been defined as L equals $N \, d\phi/di$, and since magnetizing force (H) is related to current (H equals $N [di]$ for changing values), the magnetization curve coordinate system can be changed (Fig. 25). Region A (unsaturated region): Small change in current (di) in region A results in large change in flux ($d\phi$), therefore, the inductance of a coil in this region of operation is extremely high. The denominator of L equals $d\phi/di$ is small, therefore, L is very large. This high inductance or reactance results in a very large coil impedance, creating a large opposition to current flow. Region B (transition region): The knee of the magnetization curve is the region between the unsaturated and saturated core. It represents the area where the core tends toward saturation or tends toward desaturation. Inductance, inductive reactance, and impedance are undergoing changes from values of maximum to minimum, or from minimum to maximum. Region C (saturated region): Large change in current (di) in region C results in a small change in flux ($d\phi$). Therefore, the inductance of a coil in this region of operation is very small. The denominator of L equals $N \, d\phi/di$ is large. Therefore, inductance reactance results in a very small coil impedance, creating a very small opposition to current flow.

Summary of Characteristics

Region	°Saturation of Core	Inductance (L)	Impedance (Z)	Current Flow in Coil
A	Unsaturated	High	High	Low
B	Transition	High to Low	High to Low	Low to High
C	Saturated	Low	Low	High

Review Questions

1. How does each individual loop in a coil produce a field that contributes to the overall magnetic field of the coil?
2. Explain the similarities and the differences between magnetic fields produced by coils, with that of bar magnets.
3. The mmf of a coil wound on a toroid is 250 ampere-turns when .75 amperes is flowing through the coil. Determine the magnetic intensity (H) of a coil wound on a toroid when .75 amperes is flowing through a coil of length 3.25 centimeters and 333 turns.
4. Give a statement of definition of permeability as well as mathematical expression of this definition.

5. Derive an expression relating permeability (μ) with Reluctance (\mathcal{R}). Is this an inverse relationship?
6. Explain how the slope of the magnetization curve, when changed, affects the saturated and unsaturated regions of a core.
7. Draw a hysteresis loop when the coercive force is approximately twice that of the force created by residual magnetism. Explain the cycle of operation and the relationships between the two forces.
8. Sketch an alternating sine-wave and explain the changes in magnetic field created by this wave in one cycle.
9. What is the inductance of a coil with 10 turns when the field collapses from 2,000 lines to 1,500 lines and when current changes from 5.5 amps to .13 amps?
10. Plot a curve showing the relationship of the cross-sectional area of a toroid core to its mean length, when the material under consideration has a reluctance of .03 and a permeability of 600.

A magnetic circuit is a path of low reluctance to the flow of flux lines as produced by a magnetizing force. The three basic types of simple magnetic circuits (Fig. 26) are: Air core, iron core, and iron core with air gap. To gain a better understanding of magnetic circuits as used in magnetic

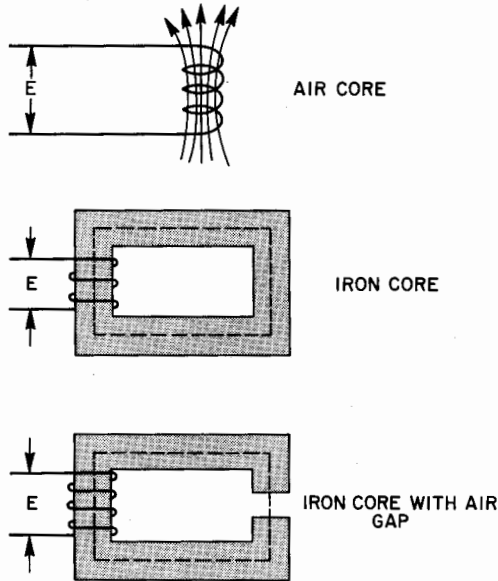

Fig. 26. Three basic types of simple magnetic circuits.

amplifiers, an analogy or comparison is made between electric and magnetic circuits. This comparison shows the similarities between them so that an understanding of electric circuits forms a basis for an easy understanding of magnetic circuits.

Comparison

<i>Parameters of electric circuits</i>	<i>Analogous parameters of magnetic circuits</i>
Electric current (I)	Magnetic flux (ϕ)
Resistance (R)	Reluctance (\mathcal{R})
Voltage (E)	Magnetomotive force (\mathcal{F})
Ohm's Law ($I = E/R$)	Magnetic law $\phi = \mathcal{F}/\mathcal{R}$
Resistivity (ρ)	Permeability (μ)
Parameters of resistance	Parameters of reluctance
$R = \rho (L/A)$	$\mathcal{F} = L/\mu A$

Where L equals Length of core; A equals Area of core

In making an analogy between electric and magnetic circuits (Fig. 27) for similarities, note that these two circuits differ in some respects: Flux is not strictly analogous to current, since current is rate of flow while flux is more nearly a state or condition of the medium established; and a

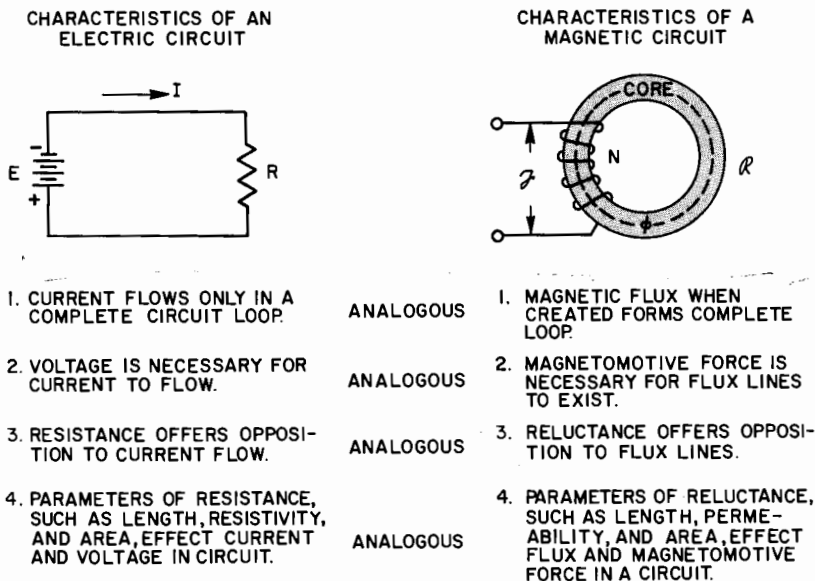

Fig. 27. Circuit analogy.

magnetic circuit can never be entirely opened since a magnetic field must exist at all times in the vicinity of a magnet while an electric circuit can be easily opened (Fig. 28).

Review Questions

1. Explain the important characteristics of a magnetic circuit.
2. Describe how reluctance varies in the three simple types of magnetic circuits.
3. If reluctance in magnetic circuits is analogous to resistance in electric circuits, show how the total reluctance of three magnetic materials in parallel is equal to:

$$R_T = \frac{R_1 R_2 R_3}{R_2 R_3 + R_1 R_2 + R_1 R_3}$$

4. In what ways do magnetic circuits differ with electric circuits?
5. Draw a sketch of three magnetic loops and show how you would increase the reluctance of one loop to a greater value than the other two.

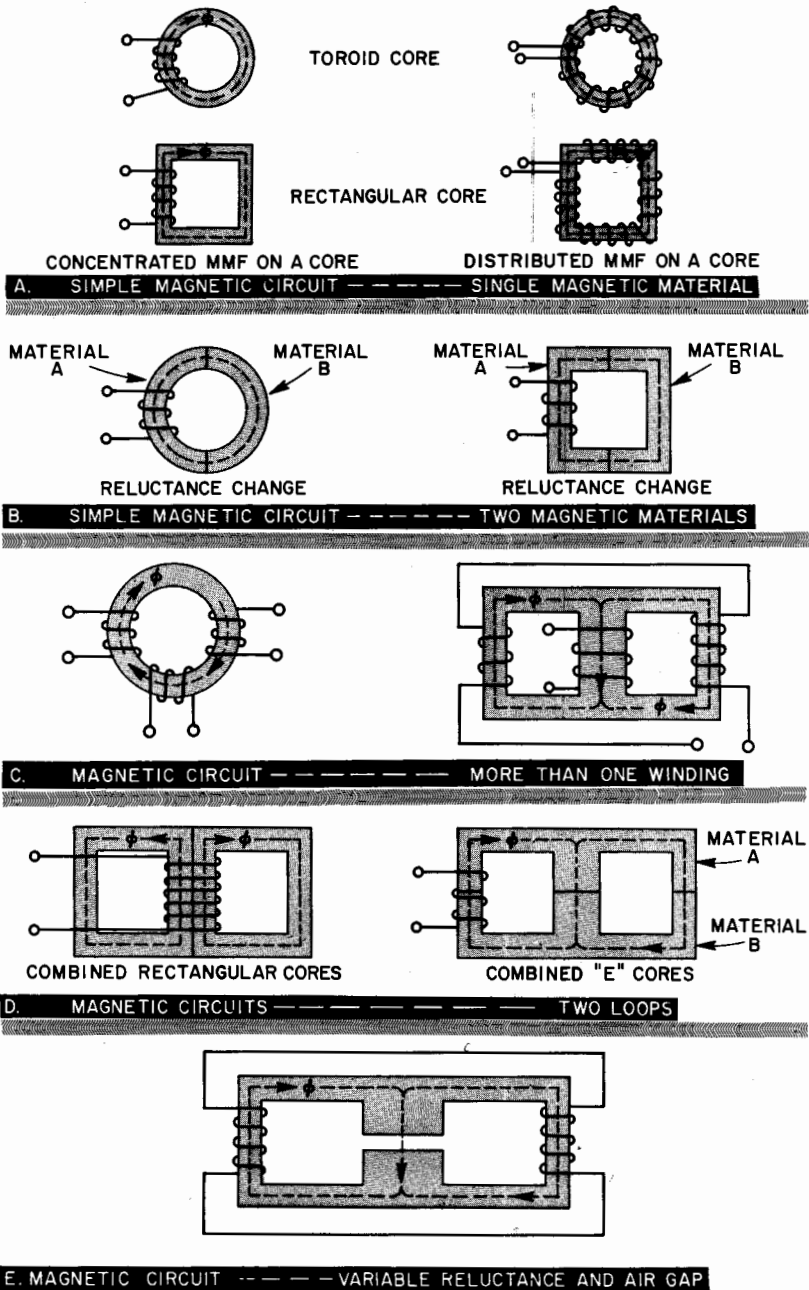

Fig. 28. Types of magnetic circuits.

THE SATURABLE REACTOR

The saturable reactor is the device from which the magnetic amplifier has been fundamentally developed. Consequently, a thorough understanding of the saturable reactor is a must before one is able to fully understand the magnetic amplifier.

The saturable reactor consists of three essential elements: Direct current source, magnetic core with windings, and alternating current source (Fig. 29).

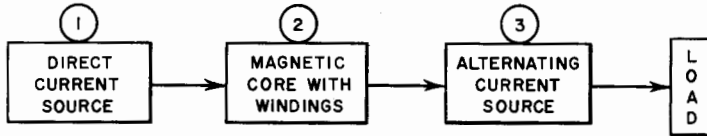

Fig. 29. Three essential elements of the saturable reactor.

The Basic Saturable Reactor

These three elements, when connected together, form the essentials of the saturable reactor. Its operation is based upon the following principle: *The flow of current from a coil wound on a magnetic core can be made to vary by varying the saturation of the core.* Following sections explain more fully this important principle upon which not only saturable reactors operate, but also magnetic amplifiers.

Simple Saturable Reactor

The simple saturable reactor (Fig. 30) consists of two electric circuits connected by a magnetic circuit, so that the operating characteristics of any one circuit effects the operation of all the interconnected circuits. In Fig. 30, d-c current in the control loop flows through windings N_1 which establish the magnetomotive force \mathcal{F}_c or ampere turns of the control winding. Current flows through this winding and sets up a d-c flux (in one direction) in the magnetic circuit loop.

Since an a-c source is connected in the load loop, a-c current flows through winding N_2 , establishing the magnetomotive force (\mathcal{F}_L or ampere-turns) of load winding N_2 . Since this current is alternating, the flux set up in the magnetic circuit loop is constantly changing in magnitude and direction.

Within the magnetic core there now exist two types of flux: (1) ϕ_{d-c} , the flux created by d-c current which is constant in magnitude and constant in direction. This means the field builds up and remains steady-state.

(2) ϕ_{a-c} , the flux created by a-c current which is changing in magnitude and changing in direction. This means the field builds up to a maximum in one direction, collapses, and builds up to a maximum in the opposite direction.

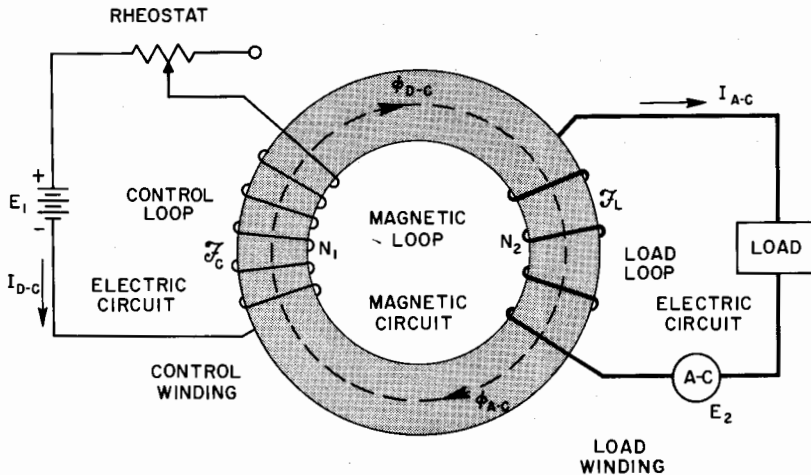

Fig. 30. Simple saturable reactor.

The a-c flux tends to saturate and then desaturate the core because of its cyclical operation. This results in a changing inductive reactance in the load winding. The d-c flux, according to its strength, aids or opposes the a-c flux in its saturate or desaturate effects in the core. Hence, the d-c flux tends to control the a-c flux controlling the reactance of the load winding. The use of separate windings on a single core has distinct advantages. Load winding N_2 consists of comparatively few turns of heavy wire because of large current requirements of different loads. Control winding N_1 consists of many turns of fine wire. Since magnetomotive force depends upon the number of ampere-turns, a small current in the control winding produces a magnetomotive force equal to that of the load winding. Usually, d-c in the order of milliamperes controls a-c in the order of amperes.

The following describes the steps in the operation and control of the simple saturable reactor: 1. *Zero d-c control current in the control loop* — A. Since only a-c current is flowing through the load windings, an extremely high inductive reactance (X_L) is present in the load windings. This is due to the high inductance (L) of the load windings and the action of the varying magnetic field produced by the a-c. B. Extremely high inductive reactance in this winding results in a high impedance (Z) which limits the flow of a-c current to a low value. This high reactance also

causes a large voltage drop across the load windings in series with the load, limiting the current supplied to the load. C. Since current is limited to a low value to the load, minimum power is transferred to the load since power is a function of current. 2. *Increase d-c control current in control loop.* A. D-c current creates a flux (ϕ_{d-c}) which, when superimposed on the a-c flux (ϕ_{a-c}), collectively saturates the core. B. Since the core is near saturation or fully saturated (core unable to hold any more flux lines), the inductive reactance is greatly reduced. This is due to the fact that no additional changing flux can be held by the core. C. With reduced inductive reactance the impedance of the load windings is greatly reduced. D. Large a-c currents are now permitted to flow through the load. E. This results in maximum power transfer to the load. 3. *Decrease d-c control current in control loop.* A. With less d-c current flowing there is less total flux in the core and the core desaturates. This results in the core's ability to support once again the changing flux (ϕ_{a-c}), creating a high inductive reactance, and resulting in increased impedance in the load winding. B. Minimum power transfer results since current to the load is greatly reduced.

This operation of the saturable reactor is shown graphically in Fig. 31. *Curve A* represents the variation of inductive reactance (X_L) or impedance (Z) with changing d-c control current. *Curve B* represents the variation of current (I) and power (P) to load, with changing d-c control current.

These curves mean: When the d-c is zero, coil impedance is maximum, and output current or power is minimum; and when the d-c increases to maximum, coil impedance decreases to minimum, and output current and power increase to maximum.

Basically, the principle of operation of the simple saturable reactor can be stated in two parts: As magnetic core saturates, current to load increases; as magnetic core desaturates, current to load decreases.

Operating Characteristics of the Simple Saturable Reactor

Using the simple saturable reactor in Fig. 30, the following information describes operating characteristics.

Linearity and distortion—The amount of d-c flowing in the control loop together with the number of turns in the winding determine the magnetomotive force (\mathcal{F}_c) of the control winding. Since magnetomotive force is equal to the magnetomotive force of the load winding (\mathcal{F}_L), operating point A on the magnetization curve is established. This point will change up or down depending on the amount of control current flowing. As can be seen in Fig. 32, when the operating point falls in the linear region the output is relatively undistorted. Consequently, the sinusoidal input, both

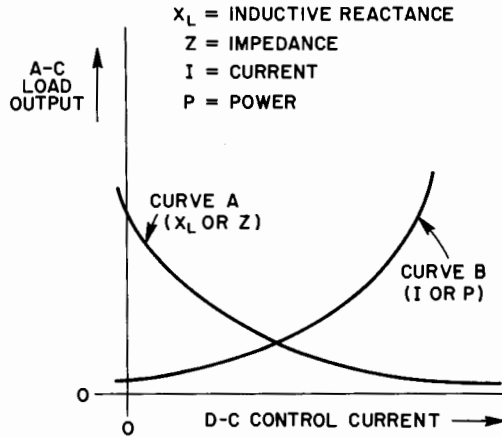

Fig. 31. Input to output relationships.

positive and negative halves, will be amplified with very little distortion. As the operating point is moved to B, the non-linear portion of the curve, by increasing the mmf, one-half the output waveform (Fig. 33) is distorted. This operation falls primarily in the transient region of the magnetization curve. The distortion occurs because the positive and negative half

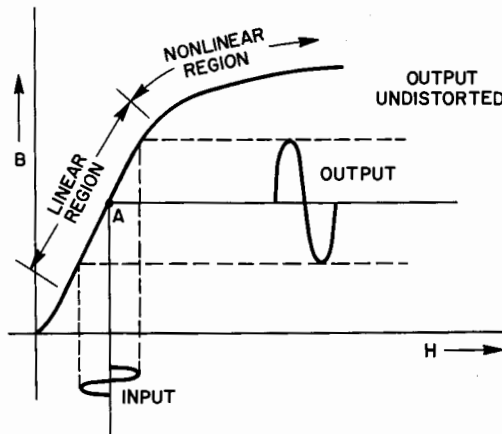

Fig. 32. Output wave when operating in linear region.

cycles of the input to the load winding operate on the nonlinear and linear portions of the magnetization curve. This means that the core is undergoing first a tendency to saturate, then a tendency to desaturate. The output results in a waveform in which the positive half cycle is distorted and the negative half cycle is undistorted.

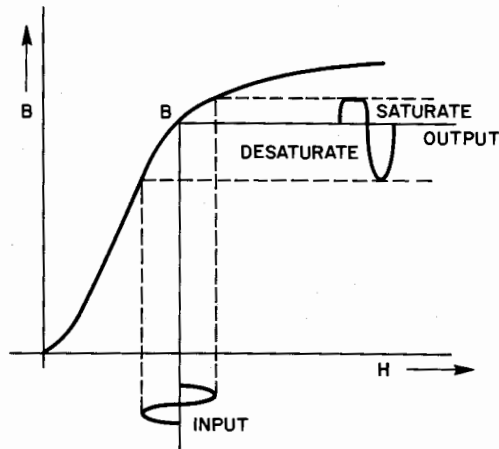

Fig. 33. Distorted output waveform.

If the operating point is moved to C (Fig. 34) by a large increase in magnetomotive force, a highly distorted output waveform results. This is due largely to very small alterations in flux which result in a small inductance. At this operating point, saturation occurs for both positive and negative half cycles, resulting in a highly distorted waveform.

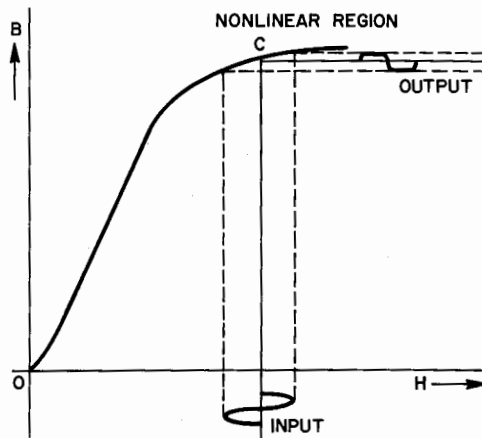

Fig. 34. Highly distorted output waveform.

Amplification — Another important operating characteristic of the simple saturable reactor is *amplification*. Fig. 35 shows the amplification of a

common sine-wave input for a particular operating point in the linear region of the magnetization curve, as fixed by the magnetomotive force of the control windings. The magnetization curve of the core material

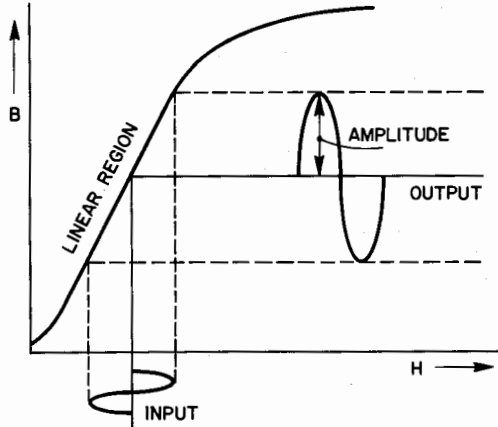

Fig. 35. Amplification in a simple saturable reactor.

determines the degree of amplification. Different types of core materials have different magnetization curves. More particularly, the slopes of these curves differ and affect the amount of amplified output.

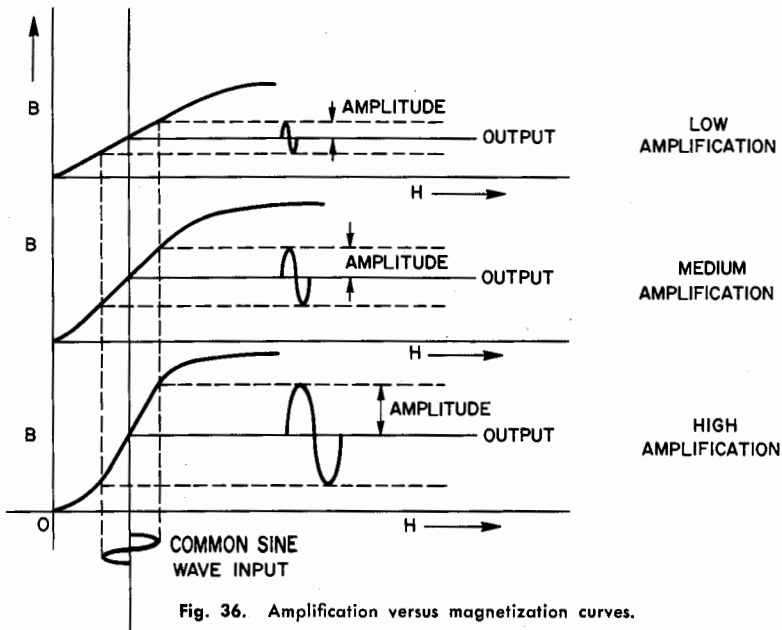

Fig. 36. Amplification versus magnetization curves.

Fig. 36 shows the effects on amplification of operating with varying slopes of different core material. The core material having the greatest slope is capable of high amplification, while the core material with least slope has a lower amplification.

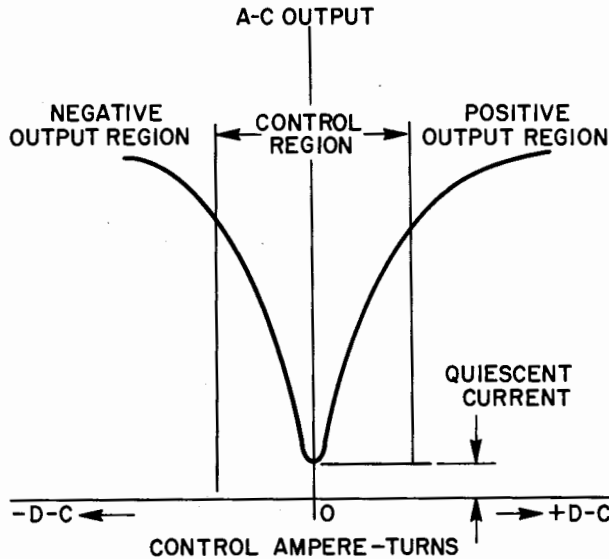

Fig. 37. Transfer characteristic curve.

Control or transfer characteristic — The control or transfer characteristic (Fig. 37) of a simple saturable reactor is a functional plot of *output* or *load current* versus *control ampere-turns* for various loads at rated voltage and frequency.

As the d-c increases either negatively or positively, saturation occurs within the core, and inductance (L) decreases, resulting in an increase in a-c output. When a zero d-c input signal exists in the control loop, a very definite low-level output signal exists in the load loop, and is called *quiescent current*. This is due to the fact that infinite impedance does not exist in the load windings. Consequently, some current passes through. To reduce the quiescent current to zero, external circuitry is required (this will be explained later).

24. 2/10/51

Review Questions

1. What are the basic elements of the saturable reactor and what principle governs its operation?
2. Name and describe in what way other electrical devices use this same principle.
3. How does impedance vary in a saturable reactor as the power output increases to a maximum?
4. Describe the current variations to a load as a magnetic core undergoes saturation.
5. What value of d-c current is required in the control winding of 500 turns of a saturable reactor when the magnetomotive force changes from 350 ampere-turns to 800 ampere-turns?
6. What is the effect on amplification when the slope of the magnetization curve is doubled?
7. Why does quiescent current exist in a saturable reactor?

SELF-SATURATING TYPES

The magnetic amplifier is a combination saturable reactor and rectifying diode, as shown in Fig. 38. Its operation is similar to saturable reactors, explained previously. The diode, connected in series with the load windings, improves its operating characteristics so that it is described as the self-saturation type of magnetic amplifier (half-wave). Fig. 39 shows a full-wave self-saturating magnetic amplifier.

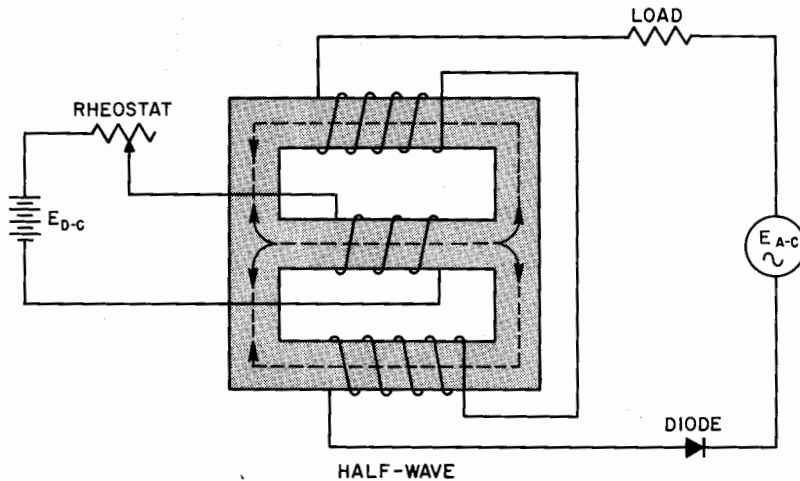

Fig. 38. Self-saturating magnetic amplifier.

The solution of four basic operational problems of the saturable reactor which placed a serious limitation on its use, spurred the development of the magnetic amplifier. These operational difficulties are: (1) *Saturate and desaturate cycles* — Every half cycle that saturates the core is followed by an equal half cycle that desaturates the core. (2) *Transformer action* — Voltages are induced in the control winding by the load winding. (3) *Quiescent current* — A definite a-c output exists in the load winding even though there is a zero d-c control current in the control winding. (4) *Polarization* — An increase in d-c current, either positive or negative, results in an increased output.

The development of the magnetic amplifier from the simple saturable reactor necessitated solving each of these difficulties and has resulted in its unlimited use in electric circuits. Following sections describe in detail how each difficulty has been solved in the current magnetic amplifier.

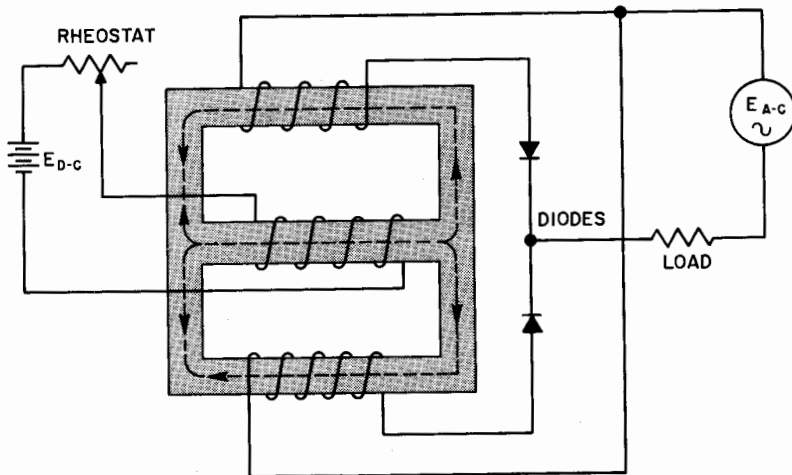

Fig. 39. Full-wave self-saturating magnetic amplifier.

Self-Saturating Magnetic Amplifier

When a-c flows in the load windings of a magnetic amplifier, a magnetic field is created within the core that reverses its direction during each half cycle of the supply voltage. During the first half of this alternating voltage, the resultant flux builds up and then collapses in one direction. During the second half cycle, it builds up and collapses in the opposite direction. Magnetic flux created in the first half cycle opposes the magnetic flux created in the second half cycle. This means that any attempt to saturate the core with magnetic flux during the first half cycle is accompanied by an equal attempt to desaturate the core during the second half. Consequently, at a desirable operating level, the core is subjected to saturating and desaturating fluxes due to the alternating nature of the supply voltage. Less gain or amplification results.

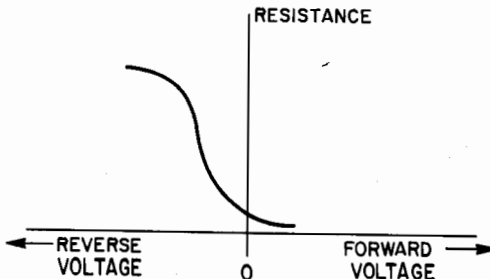
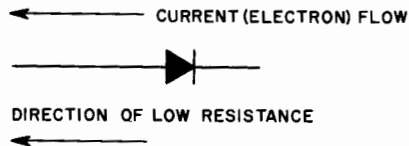

Fig. 40. Diode resistance versus applied voltage.

Elimination of the desaturating half cycle is achieved by adding a rectifying diode in the load loop. This diode blocks the desaturating half cycle due to its inherent characteristics of unilateral conductivity (ability of a device to conduct current in one direction). The ability of the diode to conduct current in one direction is due to the low ohmic resistance offered in one direction, and the extremely high ohmic resistance offered in the opposite direction (Fig. 40).

When the polarity of the alternating load voltage biases the diode in the forward voltage direction (direction of low ohmic resistance), the diode conducts current to the core to create flux in the direction of saturating the core (Fig. 41).

FORWARD VOLTAGE - DIODE CONDUCTS



REVERSE VOLTAGE - DIODE DOES NOT CONDUCT

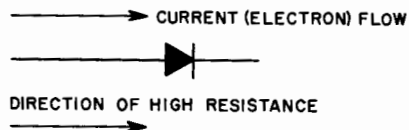

Fig. 41. A diode is a device which conducts current in one direction.

When the polarity of the alternating load voltage biases the diode in the reverse voltage direction (direction of high ohmic resistance), the diode does not conduct current to the core, but blocks or isolates the second half cycle which tends to desaturate the core. With the output current in only one direction, the reactor tends to be self-saturating. This also reduces the amount of magnetomotive force (\mathcal{F}_c) required of the control winding which is normally used to bring about saturation of the core.

The addition of a rectifier in the output winding changes the relationship between control and load current from the transfer curve, already described, to the transfer curve of Fig. 42, and represents the transfer characteristics of a self-saturating type of magnetic amplifier.

The characteristics of the transfer curve are as follows: (1) *Full output region* — Operation of the magnetic amplifier in this region results in maximum current output due to full saturation of the core. Load current is limited only by the resistance of the rectifier and load windings. (2) *Control region* — Operation of the magnetic amplifier in this region results in a current output which is limited. The core is unsaturated, which develops a variable impedance in the coil that acts to control the output current.

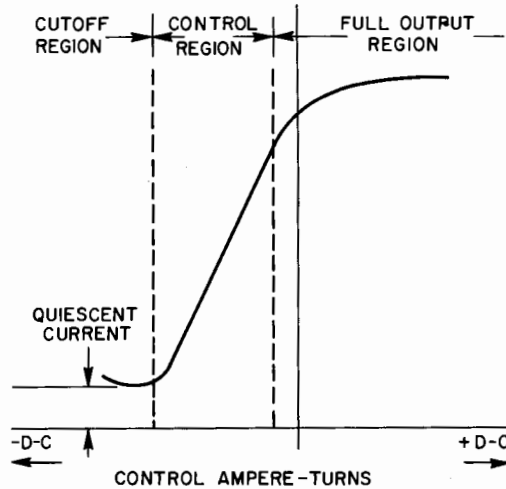

Fig. 42. Transfer characteristic of self-saturating magnetic amplifier.

(3) *Cutoff region* — Operation of the magnetic amplifier in this region results in output current being cutoff except for the small amount of quiescent current flowing. This quiescent current can be eliminated with the aid of external circuitry. This will be explained later. (4) *Polarity* — The transfer curve of the self-saturating type magnetic amplifier shows that the amplifier output is sensitive to the polarity of the control current. That is, as the control current increases positively, the output increases. As the control current increases negatively, the output decreases.

The rectifier diode has become an integral part of the magnetic amplifier because of its important role in the operation of the core. Both forward and reverse resistance have an important bearing on the operating characteristics of the magnetic amplifier.

The forward resistance tends to reduce the useful output voltage. It also causes heat losses (I^2R) within the rectifier. This is an undesirable power loss since it tends to heat again the rectifier which produces adverse effects.

The reverse resistance is important to the operation of magnetic amplifiers for the following reasons: (1) If the ratio of reverse to forward resistance is low, the amplification or gain will be considerably reduced (desaturation cycle is partially blocked). (2) Power loss caused by reverse current causes the temperature of the rectifier to increase. (3) Reverse resistance current reduces the d-c output.

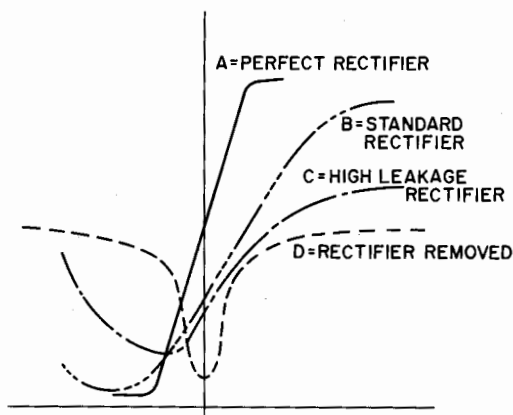

Fig. 43. Effects of rectifier leakage.

Fig. 43 shows the effects of rectifier leakage on the transfer curve during the second half cycle. It is during this cycle that the positive saturation is reduced. If the rectifier does not completely block this half of the cycle, leakage results and increased positive saturation occurs. Note how the transfer curve is changed with increasing rectifier leakage during the second half cycle.

Review Questions

1. Define what is a magnetic amplifier.
2. What four operational difficulties of the saturable reactor had to be solved before the magnetic amplifier could undergo greater acceptance?
3. In what way does the diode in the load loop eliminate the desaturating half-cycle?
4. Describe in what way the diode in the load loop changes the transfer characteristic of a magnetic amplifier.
5. For purposes of switching, in which region of the transfer characteristic would you expect the point of operation?
6. What are the effects of a low ratio of reverse to forward resistance of the rectifier diode?

Transformer action between two windings on the same core (Fig. 44), such as a toroid, creates a serious problem. With a large a-c flowing in the N_2 windings, a high voltage is induced in N_1 due to normal transformer step-up action — a function of the turns ratio. This induced voltage causes a-c to flow in the control loop, disrupting d-c control action. In fact, the high voltage induced in many turns of fine wire of a very small conductor

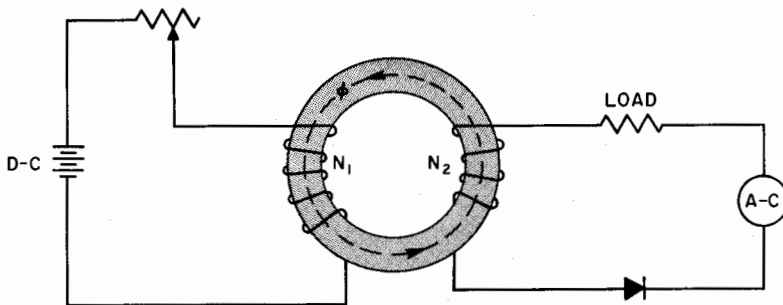

Fig. 44. Transformer action of two windings.

size, will exceed the dielectric strength and maximum voltage requirements. This results in immediate breakdown of winding N_1 . Additionally, the sensitivity and response requirements of the load demands the control loop be free of any interfering actions.

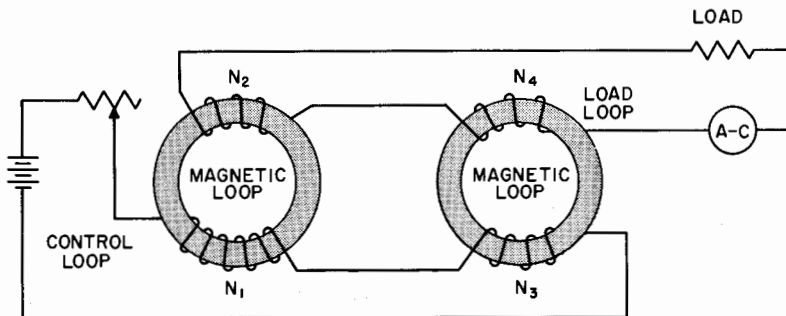

Fig. 45. Series-opposing arrangement.

Several methods have been suggested and used to nullify transformer action: (1) A highly reactive filter choke in series with the control loop has been used. Most of the induced a-c voltage appears across this choke so that very little a-c flows in the control loop. This method is not suitable, even though it frees the control loop of any interfering action of a-c. A high voltage is still induced in the control winding, eventually breaking down the wire insulation. (2) Another method connects a second core

for a series-opposing arrangement as shown in Fig. 45. This arrangement separates the single magnetic loop into two magnetic loops, with the load and control windings connected in series. Coils N_1 and N_3 are wound so that induced voltages in N_1 and N_3 are 180° out of phase with each other and therefore cancel. This is an improvement on the method using a reactive filter. However, the induced high voltages stress the coils unduly to impose a serious limitation (Fig. 46). (3) The most effective method

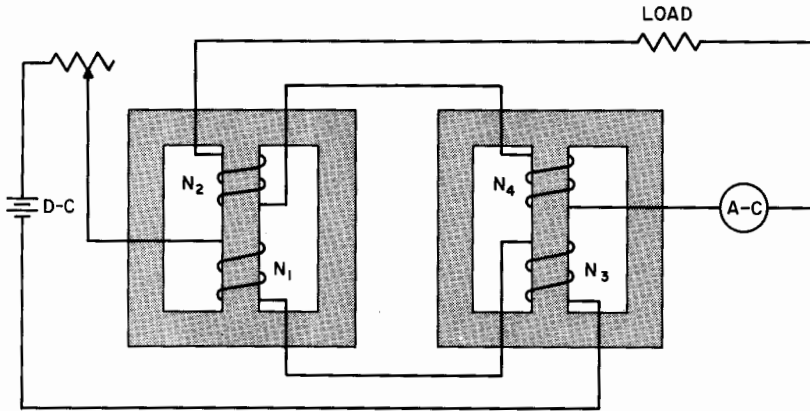

Fig. 46. Variation of series-opposing arrangement.

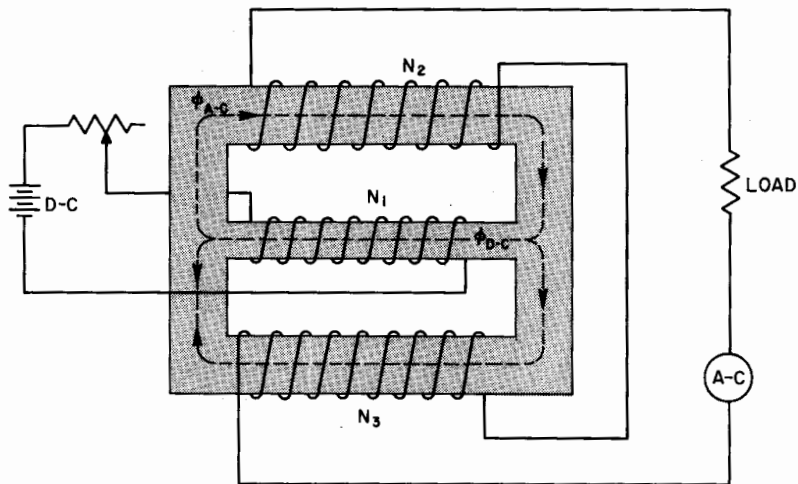

Fig. 47. Three-legged core arrangement to eliminate transformer action.

of eliminating transformer action is shown in Fig. 47. A three-legged core arrangement with the control winding in the center leg and the load winding separated into two windings is mounted on the outer legs of the core.

The construction of the outer core legs is made larger (less reluctance) than the middle leg (greater reluctance). This tends to confine all the a-c flux in the outer periphery of the core with very little entering the center core (flux taking the path of least reluctance). Flux that does not enter the center leg is cancelled, due to the directional effects of d-c and a-c fluxes.

This method of construction and winding connection eliminates the high voltage induced in the control winding, thereby freeing the control loop of an action or effect by the load loop. This arrangement also maintains the sensitivity and response demanded in critical electrical systems.

Review Questions

1. Explain transformer action between two windings of a toroid core .
2. What are the methods used to eliminate transformer action, and which is the most feasible?
3. In a three-legged core arrangement, how many magnetic loops exist in the core?

COMPENSATING MAGNETIC AMPLIFIERS

The quiescent current that exists in the output of a magnetic amplifier poses a serious problem, particularly if cascading of amplifiers is desirable. This current exists on the output because of the inability of the coil to possess impedance large enough to prevent the flow of current. Consequently, a definite output exists despite a zero d-c control current in the control loop.

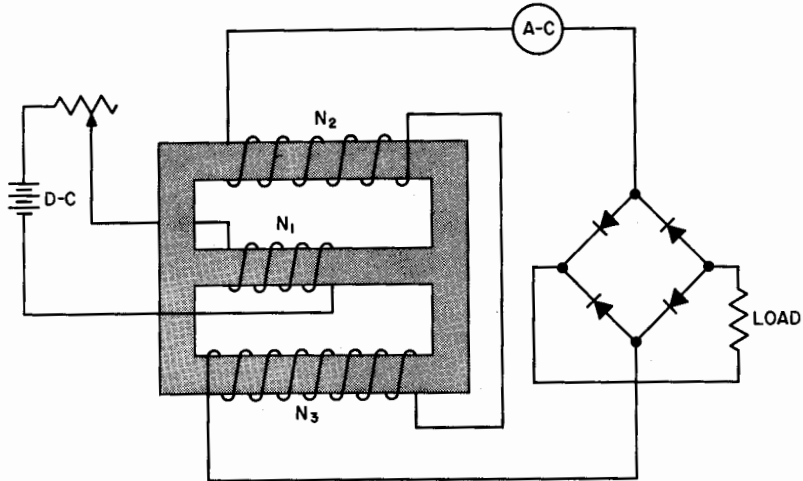

Fig. 48. Magnetic amplifier with rectifier bridge in output.

Fig. 48 represents a schematic diagram of a magnetic amplifier with a rectifier bridge. To determine the amount of quiescent current flowing in this circuit, the simplified Fig. 49 is used. Assume: (1) The inductance of coils N_2 and N_3 total 200 henries. (2) The a-c source is 110 volts, 60 cycles. (3) Impedance of the bridge is 4640 ohms.

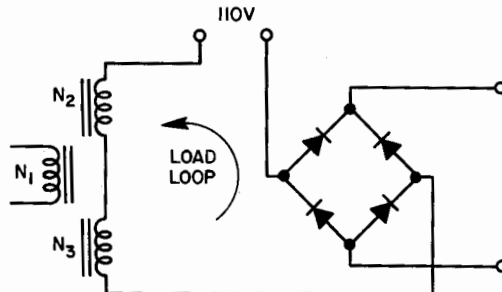

Fig. 49. Calculating quiescent current.

Then: (1) Inductance reactance (X_L) of loop equals $2\pi fL$ equals $2 \times \pi \times 60 \times 200$ equals 75,360 ohms. (2) Total impedance of loop equals 75,360 ohms-coils plus 4640 ohms-bridge equals 80,000 ohms. (3) Quiescent current (I) equals E/Z equals $110/80,000$ equals 0.00134 equals 1.34 ma.

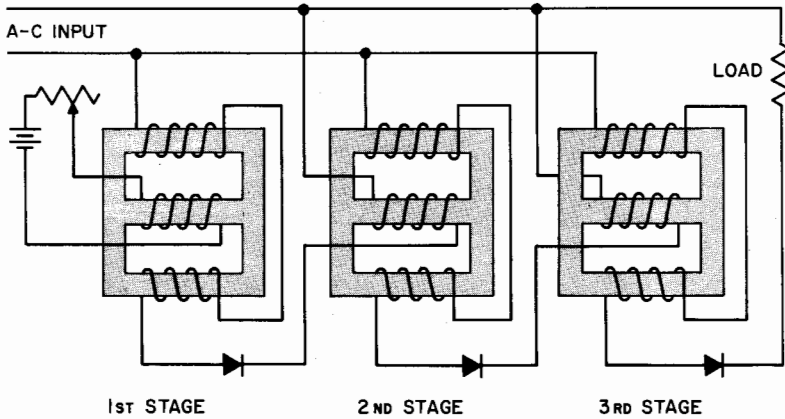

Fig. 50. Cascaded magnetic amplifiers.

This level of quiescent current becomes significantly large if the output of one amplifier is used to control another in a cascade arrangement (Fig. 50). In a cascade circuit, the overall gain is the final product of all the

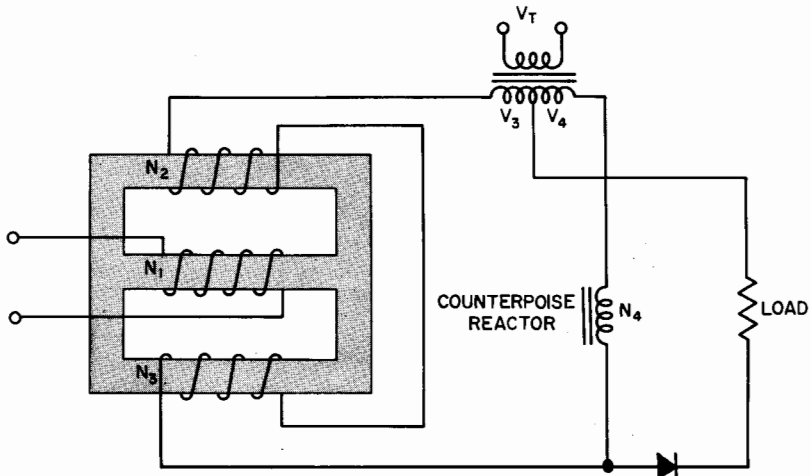

Fig. 51. Compensated magnetic amplifier.

stage gains. If the current gain for the second and third stages is 100 each, then the quiescent current output of the first stage (1.34 ma) would be increased by $100 \times 100 \times 1.34$ ma, or 13.4 amperes.

If more stages were added, this current would increase proportionately and become large enough to saturate the cores in the latter stages. This would mean an undesirable output in the load loop despite the zero d-c in it.

With this quiescent current flowing, added amplifiers are useless. To correct for quiescent current, compensated magnetic amplifiers are used. Compensated amplifiers are designed to eliminate quiescent current and to make cascading of magnetic amplifiers more practical. The use of an inductive reactor in Fig. 51 eliminates quiescent current. The use of this reactor shifts the transfer characteristic as in Fig. 52.

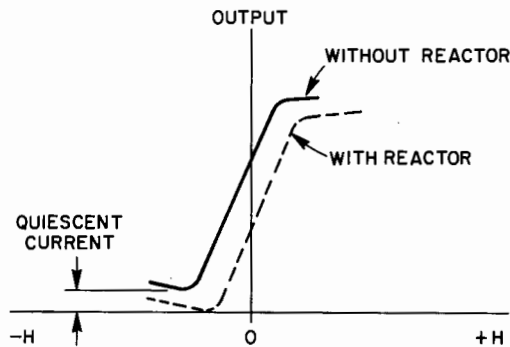

Fig. 52. Effect of adding compensating reactor.

The use of an inductor to eliminate quiescent current is explained as follows (Fig. 53): (1) Inductive reactance $X_{L\ 2+3}$ is the total reactance of the load windings. (2) Inductive reactance $X_{L\ 4}$ is the reactance of the compensating reactor. (3) When no current (d-c) is applied to N_1 , the inductive reactance of $X_{L\ 4}$ is designed in value to equal $X_{L\ 2+3}$. (4) Since these reactors are equal, the total voltage, V_T ($V_1 + V_2$) divides equally across the reactors so that V_1 equals V_2 . (5) At the source V_T equals $V_3 + V_4$ and because the tap is at the center, V_3 equals V_4 . (6) $V_1 + V_2$ equals V_T ; and $V_3 + V_4$ equals V_T ; and V_1 equals V_2 ; and V_3 equals V_4 . Then V_1 equals V_4 ; and V_2 equals V_3 . (7) No potential difference exists across the load. Hence, there will be no conduction or quiescent current flowing. (8) When control current flows, $X_{L\ 2+3}$ decreases. V_2 is now less than V_1 , and conduction takes place since a difference in potential exists.

Thus, the compensation reactor eliminates quiescent current when control current is zero, but still allows a-c loop current to flow when control current is applied (Fig. 53).

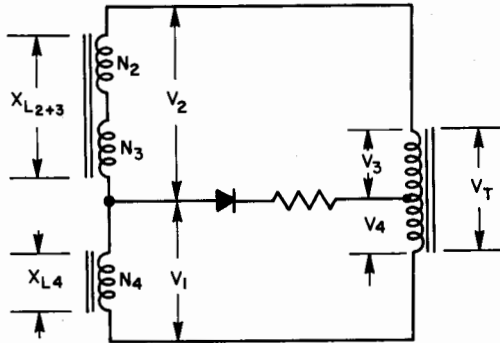

Fig. 53. Schematic diagram of a compensated magnetic amplifier.

Review Questions

1. What is meant by the term "cascade"?
2. What is the quiescent current of a magnetic amplifier with three stages cascaded, containing the following values for each stage:

Inductance of Load Coils = 75 henries

Impedance of Bridge = 3750 ohms

Gain of each stage = 10

Source of a-c = 110 volts, 60 cycles

3. In what way does an inductor eliminate quiescent current?
4. What change occurs with the transfer characteristic, with the addition of an inductor in the load loop?
5. Is there a maximum number of magnetic amplifier stages that can be practically connected together? Why?

POLARIZED MAGNETIC AMPLIFIERS

Circuits shown previously for self-saturating magnetic amplifiers were non-polarized since they could not discriminate between positive and negative d-c control current in the control winding. The self-saturated types have been somewhat polarized by the introduction of the rectifier element in the output of the load winding. Polarization is achieved in magnetic amplifiers by use of an additional winding in the center leg of the core, called the bias winding (Fig. 54).

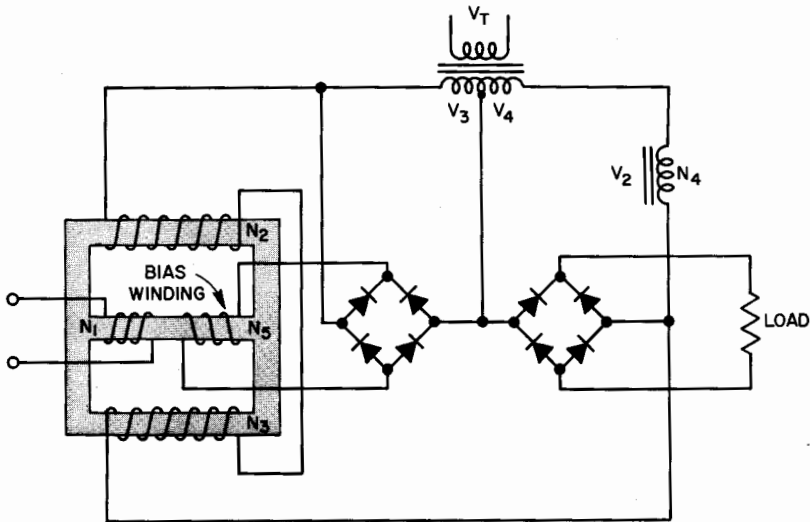

Fig. 54. Compensated magnetic amplifier with bias.

The effects of the bias winding shift the transfer curve (Fig. 55) so that the output current of the amplifier responds differentially to positive and negative control currents. Zero d-c in the control loop results in zero output in the load loop and increasing positive d-c current will produce an increase in the output loop.

The direct current flowing in the bias winding introduces a flux into the core with fixed magnitude and direction. This level of flux aids the control winding flux in bringing the core to different degrees of saturation. Hence, the amount of magnetizing force (ampere-turns) of the control winding is considerably reduced. The degree of biasing, shifting of transfer curve to the right or to the left, can be changed by altering the amount of direct current flowing in the bias winding.

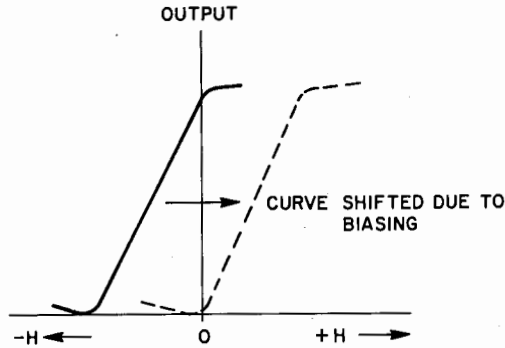

Fig. 55. Result of bias winding.

Magnetic Amplifiers With Special Windings

The specialized requirements of various electrical and electronic applications has demanded that the magnetic amplifier be highly flexible in its

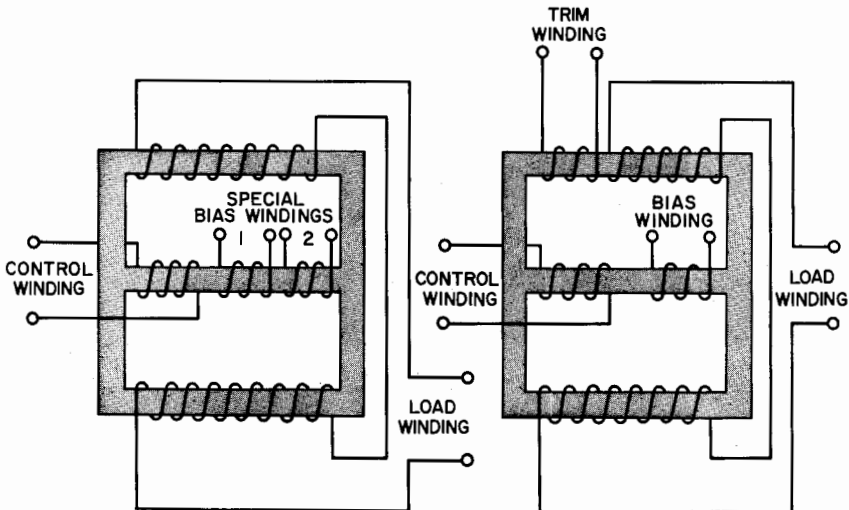

Fig. 56. Special windings.

use. These applications and their diverse systems vary radically with one another as to operating characteristics they require. The magnetic amplifier can be made highly flexible with the use of special windings (Fig. 56).

It is not possible to cover all these special windings since they not only vary in types and names, but also vary from application to application. These windings, often called special bias windings or trim windings, are used to achieve a particular operation for a particular application (Fig. 57).

SUMMARY OF CHANGES OR IMPROVEMENTS TO PRODUCE THE COMPENSATED SELF-SATURATED MAGNETIC AMPLIFIER WITH BIAS



<u>DIFFICULTIES OF SATURABLE REACTOR</u>	<u>IMPROVEMENTS</u>	<u>RESULTS</u>	<u>TRANSFER CURVE</u>
1. TRANSFORMER ACTION	1. SEPARATE A-C FROM D-C FLUXES	1. THREE-LEGGED CORE MAGNETIC AMPLIFIER	
2. SATURATE AND DE-SATURATE HALF CYCLES	2. DIODE IN LOAD WINDING	2. SELF-SATURATED TYPES MAGNETIC AMPLIFIER	
3. QUIESCENT CURRENT	3. INDUCTOR IN LOAD LOOP	3. COMPENSATED SELF-SATURATED MAGNETIC AMPLIFIER	
4. NON-POLARIZATION	4. BIAS WINDING	4. COMPENSATED SELF-SATURATED MAGNETIC AMPLIFIER WITH BIAS	

Fig. 57. Saturable reactor to magnetic amplifier.

Variations in Transfer Curve

The following curves (Fig. 58) illustrate the effects on the transfer curve due to changes in load resistance, supply voltage, and frequency.

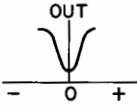
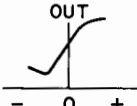
Review Questions

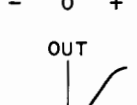
1. What is meant by the term "polarization"?
2. How is a magnetic amplifier polarized?
3. In a non-polarized magnetic amplifier, what is the output current with increasing negative d-c in the control loop?
4. What are the effects of the bias winding on the transfer characteristic?

5. What effect does the bias winding have on the magnetizing force of the control winding?
6. What great advantage does the addition of special windings give a magnetic amplifier?
7. How many magnetic loops exist in a three-legged core magnetic amplifier with load windings, control windings and two special bias windings in the center leg?

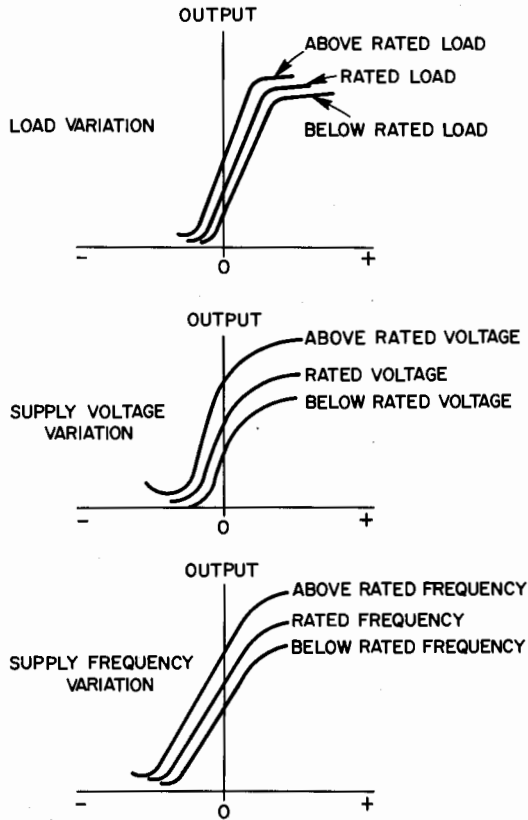

Fig. 58. Effects on the transfer curve due to changes in load resistance.

AMPLIFIER GAIN

The ratio of output voltage, current, or power in an amplifier stage to the input voltage, current, or power, respectively, represents the gain of an amplifier. Increasing the gain means increasing the output current, voltage, or power being delivered to the next stage or to a load.

Current Gain

The current gain of an amplifier is the ratio of output current to input current. Current gain (A_I) equals Load current (I_L) / Control current (I_C). It was pointed out earlier that when the amplifier operates on the linear portion of the magnetization curve, the magnetizing forces (H) of the loop and the load loop are equal. Therefore: H_c equals H_L ; $(NI)_c$ equals $(NI)_L$; $N_c I_c$ equals $N_L I_L$ — Where: H_c equals Magnetizing force of control loop; H_L equals Magnetizing force of load loop; $(NI)_c$ equals Ampere turns of control loop; $(NI)_L$ equals Ampere turns of load loop; N_c equals number of turns in control loop; N_L equals number of turns in load loop.

Rearranging: N_c/N_L equals I_L/I_c . Substituting the basic gain equation: A_I equals I_L/I_c , we have A_I equals N_c/N_L equals I_L/I_c .

The current gain of a magnetic amplifier is not only a ratio of output current to control current but also a ratio of the number of turns in the control winding to the number of turns in the load winding (Fig. 59).

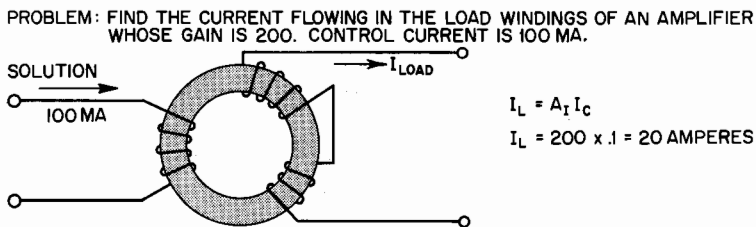

Fig. 59. Sample problem and solution.

The gain of an amplifier can also be determined graphically by determining the slope of the transfer characteristic. From analytical geometry we obtain the slope intercept form: M equals Y_2 minus Y_1/X_2 minus X_1 ; Where: M equals slope, Y and X equal coordinates. Translating this form into transfer characteristic coordinates, the current gain (Fig. 60) is the ratio of the difference in flux density to the difference in control current for any two points on the linear portion of the magnetization curve.

$$A_I = \frac{\Delta B}{\Delta I_c} = \frac{B_2 - B_1}{I_{c2} - I_{c1}}$$

PROBLEM: FIND THE GAIN OF AN AMPLIFIER WITH THE FOLLOWING TRANSFER CURVE.

SOLUTION:

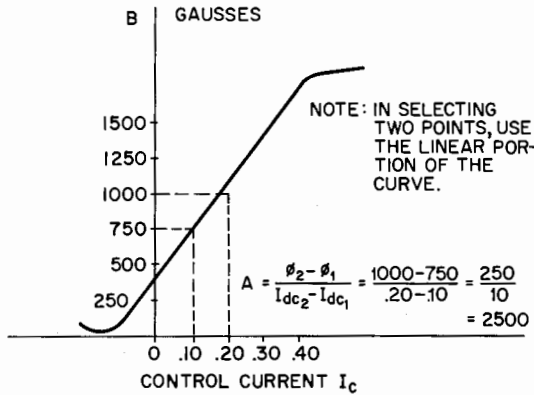
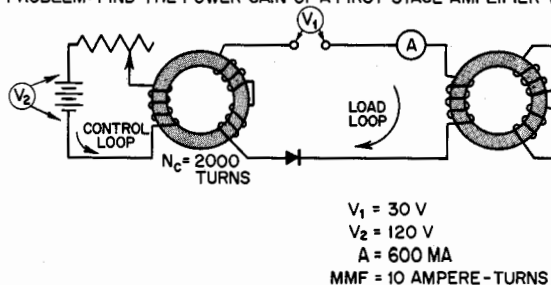

Fig. 60. The current gain is the ratio of the difference in flux density to the difference in control current.

Power Gain

Power gain of an amplifier is the ratio of the output power to the power used in the control circuit. Since: P_{out} equals $I_L^2 R_L$ and P_{in} equals $I_c^2 R_c$ and A_p equals P_{out}/P_{in} equals $I_L^2 R_L / I_c^2 R_c$ and A_p equals I_L^2 / I_{dc} times R_L / R_c equals A_I^2 times R_L / R_{dc} . Also: A_p equals $I_L V_L / I_c V_c$ equals A_I times V_L / V_{dc} . Overall gain of amplifiers in cascade: A_T equals A_1 times A_2 times A_3 (Fig. 61). Where: A_p equals power gain, I_c equals current in control loop, R_c equals resistance of control loop, I_L equals current in load loop, R_L equals resistance of load loop, A_T equals overall gain of amplifiers in cascade.

PROBLEM: FIND THE POWER GAIN OF A FIRST STAGE AMPLIFIER WITH THE BELOW LISTED VALUES.



$V_1 = 30 \text{ V}$
 $V_2 = 120 \text{ V}$
 $A = 600 \text{ MA}$
 $\text{MMF} = 10 \text{ AMPERE-TURNS}$

SOLUTION:
 $A_p = A_I^2 \frac{R_L}{R_c} = \frac{I_L V_L}{I_c V_c} = A_I \times \frac{V_L}{V_c}$
 SINCE:
 $N_c \times I_c = N_L \times I_L = 10$
 $I_L = 600 \text{ MA}$; THEREFORE,
 $N_L = 16.6 \text{ TURNS}$
 $N_c = 2,000$; THEREFORE,
 $I_{dc} = 5 \text{ MA}$
 $A_p = \frac{600}{.005} \times \frac{30}{120} = 30$

Fig. 61. Power gain is the ratio of the output to the control circuit power.

Review Questions

1. What is meant by the term "gain" of an amplifier?
2. What is the current gain of a magnetic amplifier with 50 milliamps control current and 1,250 milliamps load current?
3. Show how changes in slope of the transfer curve affects the gain of a magnetic amplifier?

Feedback in any amplifier is the process of returning a portion of the output signal to add to or subtract from the input signal. When the feedback portion of the output signal aids the input signal, the feedback is said to be regenerative or positive. When the feedback signal opposes the input signal such that the gain is reduced, the feedback is said to be degenerative, or negative (Fig. 62). Adding feedback to a magnetic

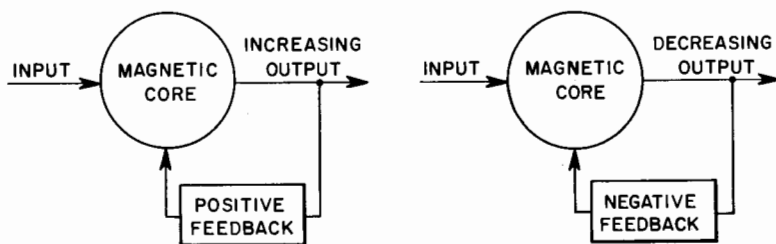

POSITIVE FEEDBACK:

WHEN FLUX OF FEEDBACK AIDS THE FLUX OF THE INPUT

NEGATIVE FEEDBACK:

WHEN FLUX OF FEEDBACK OPPOSES FLUX OF THE INPUT

Fig. 62. Positive and negative feedback.

amplifier is accomplished by an additional winding on the core. The curves in Fig. 63 show how the transfer characteristic is changed with the use of a feedback winding.

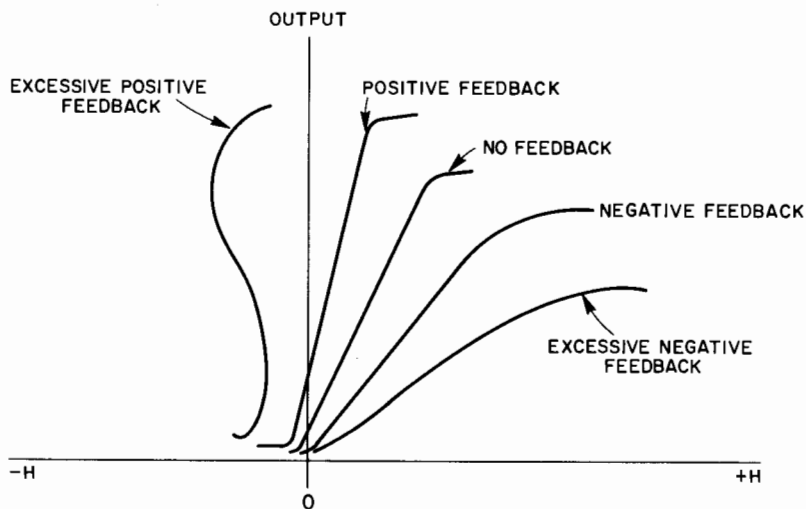

Fig. 63. Effect of feedback on transfer characteristic.

Negative Feedback

Since the feedback portion of the output signal reduces the ampere-turns of the control winding, the output is proportionately reduced. A. Linearity of transfer characteristic is improved. B. Response time is shortened or reduced. C. Power gain is reduced (note slope of curve). D. Figure of merit is increased.

Positive Feedback

Since the feedback portion of the output signal aids or increases the ampere-turns of the control winding, the output is proportionately increased: Linearity becomes poorer; response time increases, gets longer; power gain increases; figure of merit decreases.

With feedback and proper design of other parts of the magnetic amplifier, an unusual type of operation is achieved, called *bistable operation*. This means the magnetic amplifier can operate at any one of two levels or two states, at positive or negative saturation.

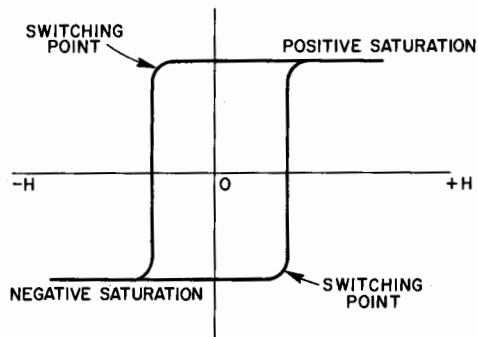

Fig. 64. Bistable operation of magnetic amplifier.

From Fig. 64 the square-appearing hysteresis loop is used for bistable operation. For increasing or decreasing values of control current, there appears switching points that change the saturation of the core and cause the output to change from a low level to a high level or from a high level to a low level. This provides the magnetic amplifier with one of two values of output, with one value of input. The magnetic amplifier with this type of bistable operation is either on or off, with no intermediate output. This operates in the same manner as a relay.

Response and Time Constants

Response time is defined as the time required for a magnetic amplifier to

reach any specific percentage of its final output value after an instantaneous change in control signal (expressed in seconds or cycles). Time constant is defined as the time required for a magnetic amplifier to reach 63% of its final output value, after an instantaneous change in control signal.

Response time and control circuit resistance are inversely proportional. Increasing the total resistance of the control loop decreases the response time of the amplifier. Decreasing the total resistance of the control loop increases the response time of the amplifier.

The use of a ratio (termed *figure of merit*) is often used in magnetic amplifiers. It is the power gain (A_p) divided by the response time (T), and expressed as power gain per cycle. Figure of merit K equals A_p/T . It shows the effects of changing, reducing, or increasing response time. A typical value of the figure of merit K (power gain per cycle) is 300–400 for low-power amplifiers and 100–200 for high-power amplifiers.

Review Questions

1. Define "negative" and "positive" feedback as used in magnetic amplifiers.
2. With increasing positive feedback, what is the effect on the transfer characteristic?
3. Is the power gain of a magnetic amplifier reduced with increasing positive feedback? Why?
4. Explain "bi-stable" operation of a magnetic amplifier.
5. Which type of feedback improves the linearity of the transfer curve?
6. What relationship exists between response time and control circuit resistance?
7. Determine the power gain of a magnetic amplifier with a figure of merit of 5, and a response time of one-half second.

GENERAL USES AND CONSTRUCTION

Magnetic amplifiers can be connected within electrical equipment in any one of five basic functional uses: (1) *Amplification* — To increase amount of current to load; (2) *Control* — To vary amount of current to a load; (3) *Switching* — To turn current to a load on or off; (4) *Memory* — To store a given current for a period of time to a load; (5) *Computation* — To vary and increase current to a load.

First Function: Amplification

The use of the magnetic amplifier for amplification within electric circuits is primarily to vary the output (increase or decrease) in accordance with variations and conditions of the input. The following describes and compares other methods and devices available in accomplishing this same function.

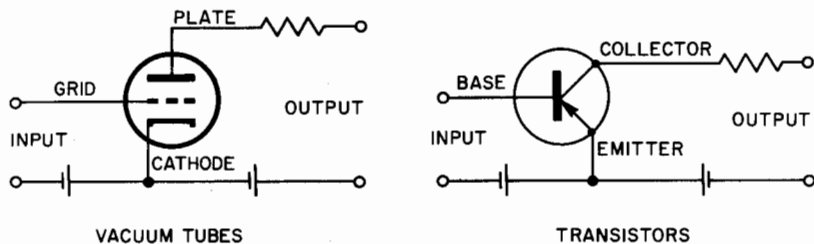

Fig. 65. Adjustable current devices.

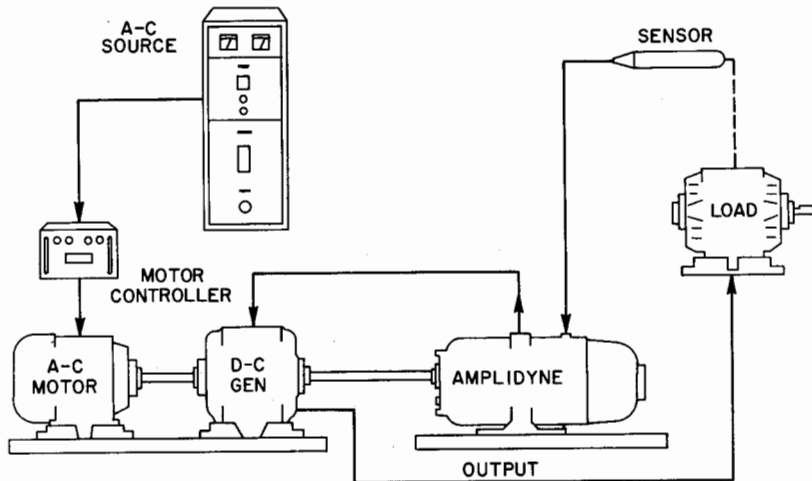

Fig. 66. Adjustable voltage system.

Electronic — Adjustable current devices (Fig. 65). The output current of these electronic devices increase from a low value to a very high value depending on the bias (control d-c voltage) of the input.

Rotating machinery — Adjustable voltage devices. The Amplidyne (General Electric trademark) is a sensor or control element which develops the variations in the control current which controls the Amplidyne (a specially constructed d-c generator for a two-stage amplifier) which in turn controls the field windings and voltage generated in a d-c generator. Voltage amplification is delivered to the load in accordance to variation in control current pickup by the sensor (Fig. 66).

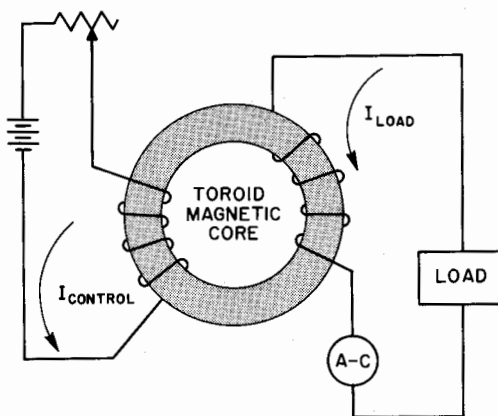

Fig. 67. Adjustable inductance system.

Magnetic — Adjustable inductance devices. The control current varies the impedance of the magnetic core which permits more or less current flow in output (Fig. 67).

Second Function: Control

The use of the magnetic amplifier for control purposes within electric circuits is primarily to regulate, within limits (maximum and minimum),

ALTER RESISTANCE

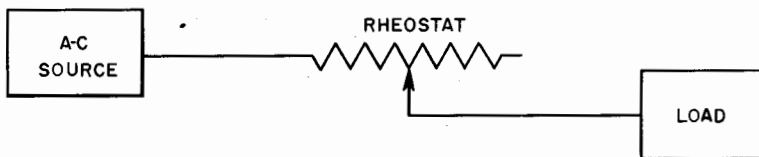

Fig. 68A. Variable resistance method.

the current being delivered to a load. The following describes and compares other methods and devices available in accomplishing this same function.

Variable resistance methods—By altering the amount of resistance between a source and the load (Fig. 68A).

Variable thermionic emission methods—By altering the amount of electron emission between cathode and plate (Fig. 68B).

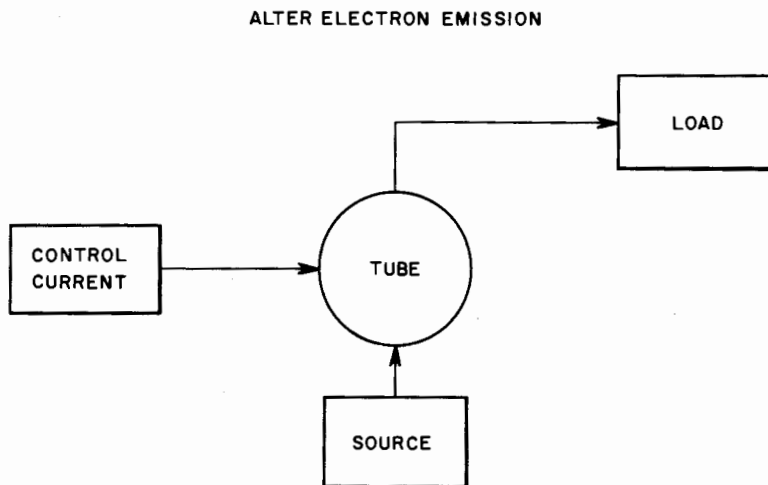

Fig. 68B. Variable thermionic emission method.

Variable reactance methods—By altering the amount of inductive reactance between source and load (Fig. 69).

Third Function: Switching

The use of the magnetic amplifier for switching purposes within electric circuits is primarily to turn *on* or *off* the current being delivered to a load, or to change connections of a circuit (Figs. 70A and 70B).

Fourth Function: Memory

The use of the magnetic amplifier for storage purposes within electric circuits is primarily to hold a given state or condition intended for a load for a period of time. Fig. 71 describes and compares other methods and devices available in accomplishing this same function.

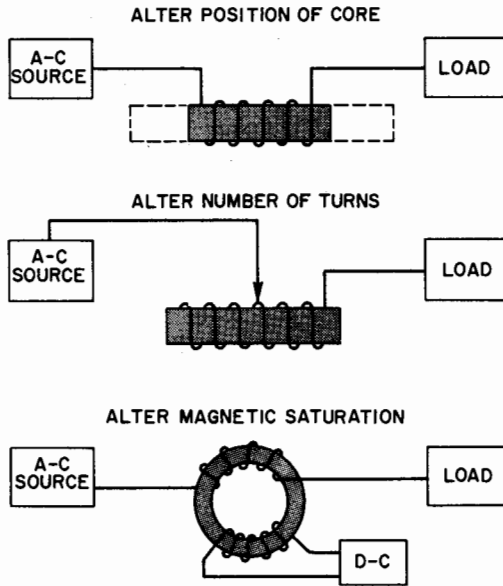

Fig. 69. Variable reactance methods.

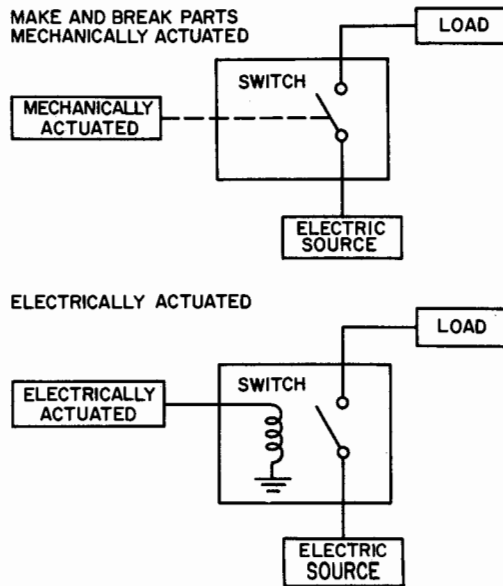

Fig. 70A. Make and break parts mechanically actuated.

MAGNETIC AMPLIFIERS

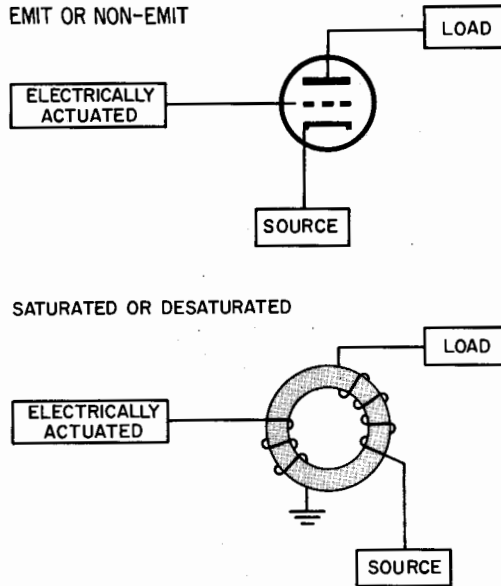
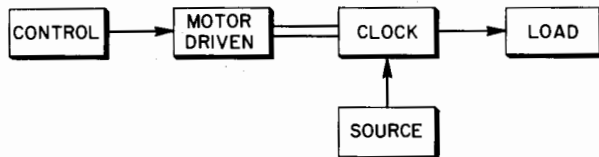

Fig. 70B. Non-make or break of parts.

ELECTROMECHANICAL DEVICES



MAGNETIC AMPLIFIERS

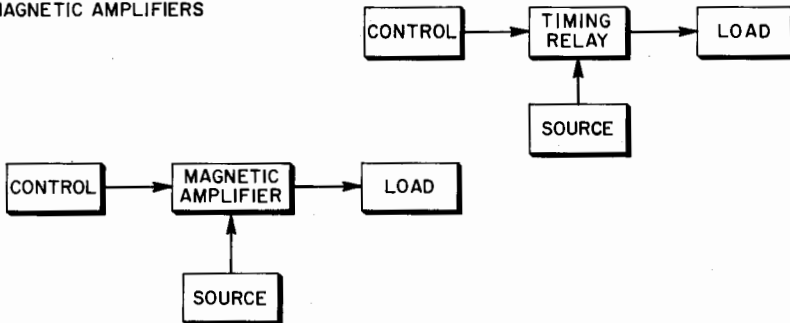

Fig. 71. Use of the magnetic amplifier for storage purposes within electric circuits.

Fifth Function: Computation

The use of the magnetic amplifier for computation is primarily to solve mathematical equations. Integration or summing up is one of the principle operations it can solve. Fig. 72 describes other methods in doing this.

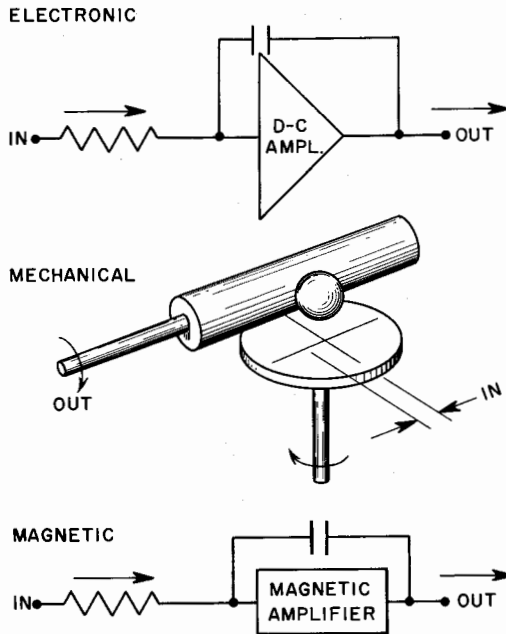

Fig. 72. Computation function.

Magnetic amplifiers can be used in circuits requiring amplification, control, switching, storage, or computation. Other methods and devices are available to achieve these same circuit functions. Each method or device has advantages and disadvantages in accordance to the way it is applied in circuits. Be alert to any indiscriminate comparison of magnetic amplifiers with other devices and methods. A valid comparison can be made only on a point by point evaluation of an advantage or disadvantage within a circuit. However, even this method becomes very difficult since advantages and disadvantages can be so drastically altered by the way in which these devices are applied. This difficulty is furthered because of the inherent characteristic differences which give one or the other an advantage in one circuit but not in another. The following describes the advantages and disadvantages of magnetic amplifiers, relative to other components fulfilling the same function.

Summary of Functional uses of Magnetic Amplifiers With Other Devices

AMPLIFICATION		
<i>Method</i>	<i>Device</i>	<i>Principle</i>
Electronic	Vacuum tube	Adjustable voltage
	Transistor	Adjustable current
Rotating machines	Amplidyne	Adjustable voltage
Magnetic	Magnetic amplifier	Adjustable inductance
CONTROL		
Resistance	Rheostat	Alter resistance
Thermionic emission	Vacuum tube	Alter electron emission
Reactance	Solenoid	Alter position of core
	Auto transformer	Alter number of turns
	Magnetic amplifier	Alter magnetic saturation
SWITCHING		
Make and break parts	Toggle	Open and close contacts
	Relay	Open and close contacts
Non-make and break parts	Vacuum tube	Emit or non-emit
	Magnetic amplifier	Saturate or desaturate
MEMORY		
Electromechanical	Clock	Actuator delays
	Timing relay	Actuator delays
Magnetic	Magnetic amplifier	Residual magnetism
COMPUTATION		
Electronic	D-c operational amplifier	Adjustable & varying current
Mechanical	Mechanical integrator	Summing incremental distances
Magnetic	Magnetic amplifier	Adjustable & varying current

Advantages of Magnetic Amplifiers

Stepless control. A. Uniform control, continuously variable over a wide range, is made possible without interrupting power in the main circuit. B. No make or break parts in adjusting conditions in the system.

Long life. A. Static devices (no moving parts, contacts, or bearings). B. Rugged and simple in construction. C. Can be hermetically sealed to resist effects of adverse environmental conditions. D. Periodic maintenance eliminated, no tube replacement. E. Life of magnetic amplifier is determined by life of associated rectifier diodes — in excess of 20,000 hours.

High power gain. A. Adjustable gain: Large amounts of power can be controlled using small amounts of d-c power. Gain equals output/input. B. Gain of several million from single-stage amplifier is possible.

Noiseless control. A. Noiseless control due to operation based on altering saturation of core. B. Low hum; no more than transformer of similar rating.

High efficiency. A. No filament heating power is required. B. Low internal power loss, since internal impedance is largely reactive and the only resistance is that of the windings and forward resistance of the rectifiers. C. Overall efficiency is usually better than 50% and as high as 80–90% in the larger sizes.

Control remotely. Manual or automatic control can be centrally located, or some distance from the reactor.

Safety. Input and output can be isolated electrically. High potential power requirements can be isolated from low potential coil and metering requirements, removing hazards from operating personnel.

Accuracy. A. Closely controlled predictable currents to permit closely controlled allowable increments in main power transfer. B. Isolation of power currents from control currents improves accuracy.

Reliability and maintenance (by nature of parts). A. Can easily meet high-shock requirements. High-shock is sudden mechanical stress intended to bring about a component failure. It is a requirement for all equipment installed for the U. S. Navy and other armed forces. B. Can easily meet vibration requirements. Vibration is any periodic mechanical stress. C. Can easily meet acceleration requirements. Acceleration is a change in the functional aspects of components as a result of rate of velocity changes. D. No filaments to burn out as with electron tubes.

Systems component. Control windings and load windings (Fig. 73) may be matched to signal and load impedances, respectively. Maximum power transfer occurs when impedance of the load equals that of the source.

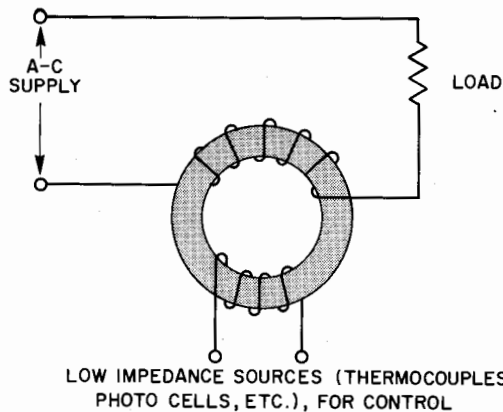

Fig. 73. Load windings may be matched to load impedances.

Duty cycle and overloading. A. Longer duty cycle than electron tubes for handling momentary overloads. Duty cycle equals average power/peak power. B. A magnetic amplifier can carry overloads equal to an equivalent transformer.

Disadvantages of Magnetic Amplifiers

Calibration. Not easily calibrated or adjusted, because of the special equipment required.

Cost. A. Relative newness and low production rates make first cost high. However, the cost of a magnetic amplifier control system over a period of time may be lower due to savings in maintenance costs and fewer production stoppages because of breakdowns. B. Nonfamiliarity of use from operating personnel makes repair and maintenance more costly.

Stability. A. Poor stability; stabilizing circuits are generally required with added loss in gain. (Stability means maintaining certain characteristics constant despite changes in voltage, temperature, etc. High inductance loads create instability.) B. Poor line regulation amplified. Small changes in a-c supply voltage cause a relatively large change in the output of most magnetic amplifier circuits. Additional circuits are needed to minimize this.

Impedance range. Impedance of magnetic amplifiers cannot be increased to infinity or decreased to zero. Full output (core saturated) impedance is reduced to d-c resistance of core windings. With output set for zero, zero d-c control current, and maximum impedance, there is still a small amount of a-c output.

Frequency response. A. Because magnetic amplifiers operate from a-c supply voltages, they cannot be expected to respond to frequencies higher than the supply voltage frequency. An amplifier operated from a 60-cycle line should not be expected to amplify control signals with frequencies over 60 cycles.

Sensitivity and distortion. A. D-c signals smaller than 1 microwatt cannot be satisfactorily handled by present commercially available magnetic amplifiers. B. The output of a magnetic amplifier is a highly distorted wave form of the supply voltage frequency. Presence of carrier frequency and harmonics is a severe handicap in certain applications.

Construction (Fig. 74)

Core types. In the design and construction of magnetic cores, it is desirable that the following properties be maintained: (1) Minimum hysteresis and eddy current losses. This means low resistivity, coercive force, and ability to construct core in thin laminations or tapes. (2) High saturation flux

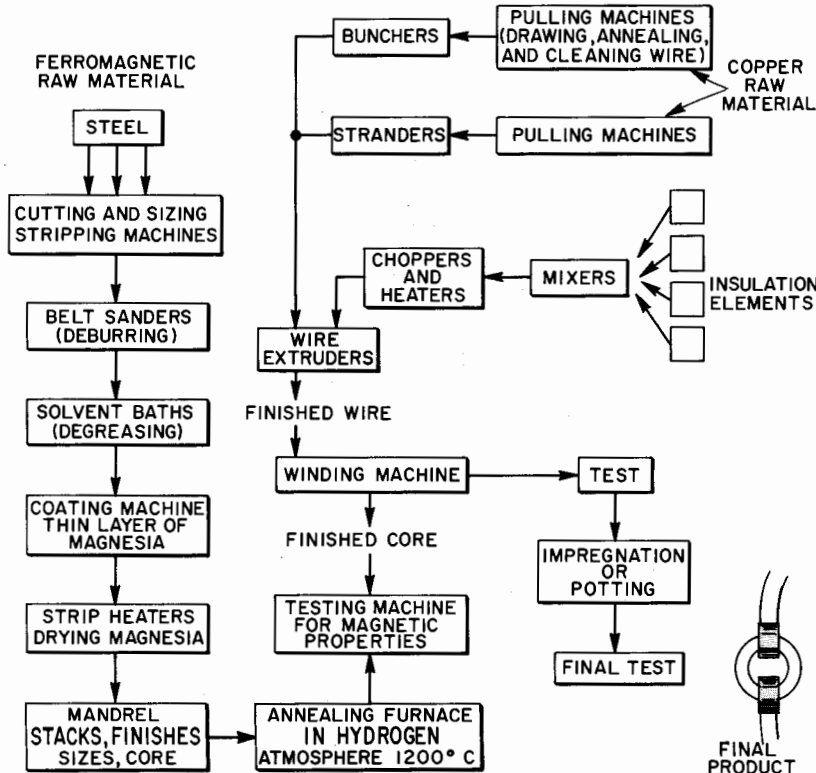
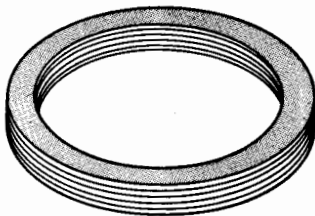

Fig. 74. Construction of a magnetic amplifier.

density, for large power-handling capacity for a given weight of core material: (3) Hysteresis loop—as nearly rectangular as possible. (4) High stability of magnetic characteristics and changing temperatures.

The more popular types of cores used in magnetic amplifiers are as follows: *Ring cores (toroids)*. Several types have been developed (Fig. 75), each containing a magnetic characteristic superior to the other in some particular installation.



STACKED RING TOROIDAL CORE

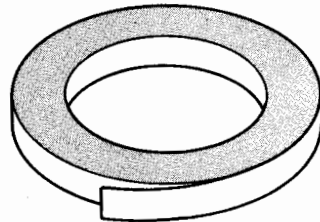

TAPE WOUND TOROIDAL CORE

Fig. 75. Ring core toroids.

Rectangular cores. Rectangular laminations (Fig. 76) having one or more legs to hold the windings are frequently used. Many of these are called U and I punchings because of their shape and may contain as many as four legs. Economy in stacking time, best arrangement to facilitate dissipation of heat from coils, and magnetic characteristics are some of the factors which determine the shape and type of core to be used.

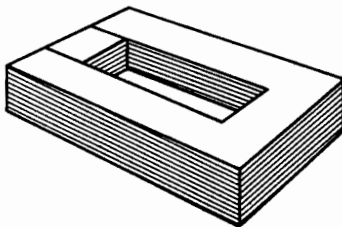

TWO-LEGGED
RECTANGULAR CORE

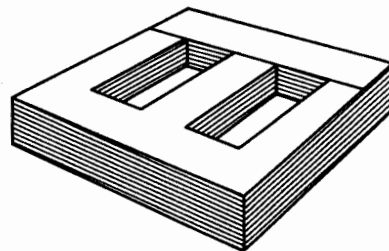

THREE-LEGGED
RECTANGULAR CORE

Fig. 76. Rectangular laminations.

Insulation of core. Before the coil is wound on the core, the core is insulated to meet high-voltage tests between windings and ground. This insulation is lapped in various ways to meet requirements of high voltage tests of no more than 1300 volts between winding and ground.

Coil winding. Coils are usually wound by a winding machine on a straight arbor on which is placed a piece of heavy insulation to serve as a mechanical support as well as to provide electrical insulation to the ground. Where the smallest possible overall size is wanted, the opening in the center is kept to a minimum; hence, the winding is put on by hand. This a slow and tedious procedure which makes the unit expensive. Layer insulation, coil wrappers or channels, are placed over the coil to hold wire without dropping turns and for protection. Coil ends or pigtails are brought out for necessary connections.

Insulation. Proper insulation between turns, layers, and coils, and to core and ground, follow normal transformer practice. Proper insulation class is observed in accordance with ambient temperatures, to avoid insulation breakdown. Class A is limited to 105°C hot-spot temperature, Class B is limited to 130°C hot-spot temperature, Class H is limited to 180° hot-spot temperature.

Review Questions

1. List the five basic functional uses of magnetic amplifiers. Explain the current behavior requirements of each functional use.
2. Compare devices used for control purposes as to methods and principle of operation.
3. What reasons exist in preventing anyone from saying that magnetic amplifier devices are best for amplification, control, switching, etc.?
4. Long life of the magnetic amplifier is attributed to what factors?
5. What values of efficiency are attainable with magnetic amplifiers? What factors reduce this efficiency? What factors increase this efficiency?
6. What is meant by hi-shock requirements?
7. What disadvantages exist in the use of magnetic amplifiers and how can they be overcome?
8. What is the basic reason for the construction and development of different core types?
9. Explain the factors which determine the shape and type of core used in magnetic amplifiers.

MAINTENANCE AND TROUBLESHOOTING

A systematic technique must be employed to identify, localize, and remedy troubles. Almost without exception, magnetic amplifiers are manufactured with extremely reliable components. Long periods of service are to be expected with minimum maintenance. However, there are certain basic maintenance rules worth following, to ensure continuance of their inherent long service life. Since the magnetic amplifier is designed into a system, system analysis and maintenance technique is required. The systematic approach is as follows: (1) Identify the type of trouble and establish its origin in the system; (2) Localize the trouble to a faulty circuit; (3) Locate the faulty components within the circuit; (4) Remedy the trouble by disassembling, repairing, or replacing the faulty component; (5) Test the equipment for proper operation after repair.

Preventive Maintenance

Preventive maintenance is the technique of detecting and correcting troubles before they occur. Preventive maintenance is easier to practice with machinery or something which has moving and wearing parts, than with electronic equipment or magnetic amplifiers which do not have moving parts. There are some preventive rules, however, which can be used for magnetic amplifiers.

(1) *Equipment.* Periodic inspection should be made to ensure that the equipment is not subjected to atmospheric conditions such as high humidity, corrosive fumes, vapors of certain chemicals and other damaging conditions. Periodic inspection and cleaning should also be made to clear any foreign matter which might impede free circulation of cooling air around heat generating equipment. All equipment should be inspected for cleanliness, discoloration, swelling, peeling, corrosion, frayed insulation, etc. The chassis must be kept dry and free of dirt, grease, and oil.

(2) *Mechanical.* Check all mounting bolts, screws, etc., to be sure that they are not working loose due to vibration. In addition, be sure mechanical parts requiring movements have freedom of action.

(3) *Saturable reactor.* Check periodically to be sure no damage is being done to the saturable reactor. They should never be operated over their rating. The line voltage must not exceed the rating stipulated by the magnetic amplifier and the load must not consume more power than can be delivered safely by the power supply.

(4) *Resistors.* Check for excessive discoloration due to overheating. If this is evident, test the resistor for proper value.

(5) *Rectifiers.* As rectifiers are used for a period of time, they begin to show signs of aging. Aging increases their internal resistance and reduces their efficiency. This results in a decrease in output current and voltage. High internal resistance will be noted by abnormally high calibrator settings when adjusting the line voltage.

(6) *Fuses or circuit breakers.* Check all circuit protective devices to be sure they are not open. Also check to be certain the protective device will function in the event of a short circuit or overload, to protect the component it serves. If a protective device opens twice in succession, do not replace it until the cause of failure has been corrected.

Corrective Maintenance

The technique of repair or readjustment of components or equipment after failure or malfunction involves the following (which must be observed to apply properly corrective maintenance).

(1) A thorough understanding of magnetic amplifier theory and the systems of which it is a part. (2) Knowledge of manufacturers' manuals, instruction books, and tables is important, to get specific values of the components involved (e.g., resistances of windings). (3) To determine whether any trouble lies in the amplifier or in other sections of the system, the simplest method of determining this is to apply a voltmeter to the output of the amplifier. If the output of the amplifier is correct (according to that specified by the manufacturer), the trouble lies elsewhere, and not in the amplifier. (4) When the output of the amplifier is not correct, a step-by-step analysis from output to input will determine the location of the trouble.

Troubleshooting

Troubleshooting methods employed for magnetic amplifiers are like those for any similar electrical control device. (See Troubleshooting Chart.)

(1) Measure the voltages across each winding to be sure each winding is energized and performing its function. Control windings, bias windings, load windings, trim windings, etc., should be measured. These voltages should agree with values specified by the manufacturer.

(2) If voltages across any windings are not according to specified values, the magnetic amplifier should be de-energized and resistance measurements taken at certain ambient temperatures, and compared with the manufacturer's values.

(3) No attempt should be made to adjust circuits by altering fixed component values. These are carefully designed, taking time constants into consideration. Changing values can very likely start the system hunting.

(4) Approximately 90% of all troubles associated with magnetic amplifiers are found to be with the rectifiers. Before continuity and voltage checks are made on the windings, the rectifiers should be checked. High temperatures may damage the rectifiers and shorten their life. Replace the rectifier if output current has fallen more than 10% from its daily reading, provided output voltage and load are the same. Be sure reduced output current is not caused by a loose connection.

Troubleshooting Chart for Magnetic Amplifiers

SYMPTOM	PROBABLE CAUSE	REMEDY
Meter or output voltage reads zero	Open circuit	Close breaker or replace fuse
	breaker or force	
	Loss of input power to control or load windings	Check circuits or circuit components of power sources
	Open rectifier stack	Check continuity with ohm meter replace rectifiers
	Open windings	Check continuity with ohm meter replace reactor
All indicators inoperative	Faulty indicating light	Replace bulb
	Loss of power to light	Check power supply
Incorrect output voltage readings	Faulty or aged components	Identify faulty circuit then identify faulty component and replace
	Shorted windings (control or load)	Check resistances of windings replace reactor
Constant output for all values of a changing input	Faulty saturable reactor	Replace reactor
Overheating or smoking of rectifiers	Shorted or grounded connection in pre-amplifier circuits	Remove shorts and grounds replace defective components

	Faulty rectifier	Check input and output voltages replace if necessary
	Check rectifier for aging	Note day-by-day changes in output
Sharp decrease in rectifier output voltage	Shorted rectifier stack	Check forward and reverse resistances of rectifiers; replace
Overheating or smoking of resistors	Shorted or grounded connection in circuit containing resistor	Check the circuit containing resistor, isolate and repair
Continuous blowing of fuses	Shorted component or grounded connection in amplifier	Check power supply circuit components

Review Questions

1. Despite the long service life of magnetic amplifiers, what are the reasons for preventive maintenance?
2. What is the systematic approach to general maintenance of magnetic amplifiers?
3. What causes a gradual reduction in efficiency and output current?
4. Which part of the magnetic amplifier causes the greatest trouble?
5. Rectifiers are replaced at what reduced values of output current?
6. What are the probable causes of incorrect output voltage readings?

SYSTEM APPLICATIONS

Magnetic amplifiers find increasing applications in electrical systems. This increased use is largely due to the realization by designers of its versatility, flexibility, and reliability. In the applications which follow, CW represents control winding, ILW represents input load winding, OLV represents output load winding, BW represents bias winding, and FBW represents feedback winding.

Power Control to Electric Heaters

Electric heating deals with the conversion of electrical energy into heat and the distribution and practical use of the heat so produced. The success of large installations of electric heating depends not only on the amount of heat that could be supplied, but also the control of this heat. Electric heating, because it is favorably low cost in certain regions, is being used more extensively for industrial applications. The two general methods of electric heating are: The electric arc (limited in application), and resistance heating (wide application). Alternating current is primarily used in this type of heater, although direct current can be used. The resistance heating method is based on the I^2R effect, and is related as follows: Q equals I^2Rt ; Where I equals current in amperes, R equals resistance of path in ohms, t equals time in which current is flowing in seconds, and Q equals amount of heat produced in btu's.

From the preceding equation, the current (I^2) becomes the significant term in producing heat. Any control system to be used to control this current, must employ a method in which current can be varied.

The following method describes an automatic control system for a large heater installation (200 kva and above) in which heat is not only produced, but varied and controlled for short periods of time.

Fig. 77 shows a two-stage magnetic power amplifier used to control a large three-phase saturable reactor. The thermal sensing device generates a signal proportional to the temperature or changes in temperature of the heaters, and feeds this signal to a controller. This controller compares this actual temperature with an ordered temperature so that a signal is generated that represents the difference, if any. If there is a difference, this signal is then used to actuate a motor-driven powerstat that varies the input control to two stages of magnetic power amplifiers. The output of the final stage becomes the input control of the saturable reactor that connects and controls the supply current to the heaters. This current to the heaters is varied in accordance to the degree of saturation of the reactor. By this method, tremendous amounts of current or power can be released and controlled to a bank or system of heaters.

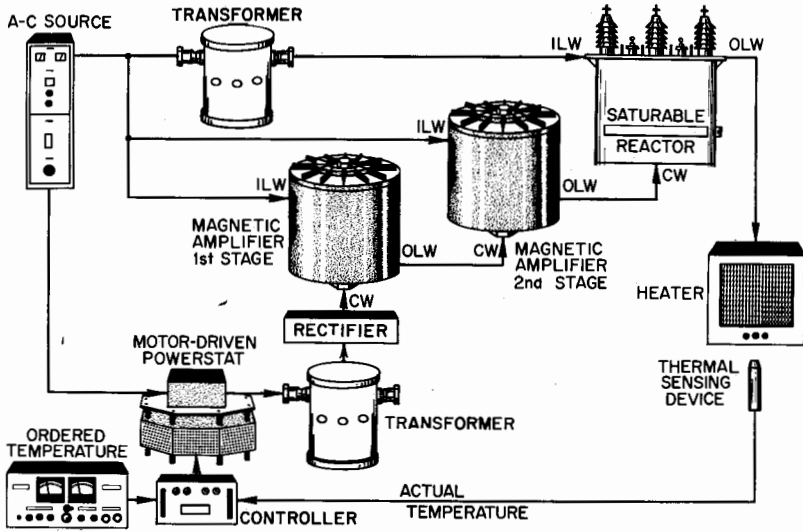

Fig. 77. Automatic heating system.

Solenoid Valve Control

A solenoid is an electromagnet having an energizing coil (somewhat cylindrical in shape) which acts on a movable ferromagnetic core or plunger positioned in the center of the coil.

Magnetic amplifiers provide a means of controlling solenoid-activated valves (Fig. 78) in piping or hydraulic systems. Manual or automatic con-

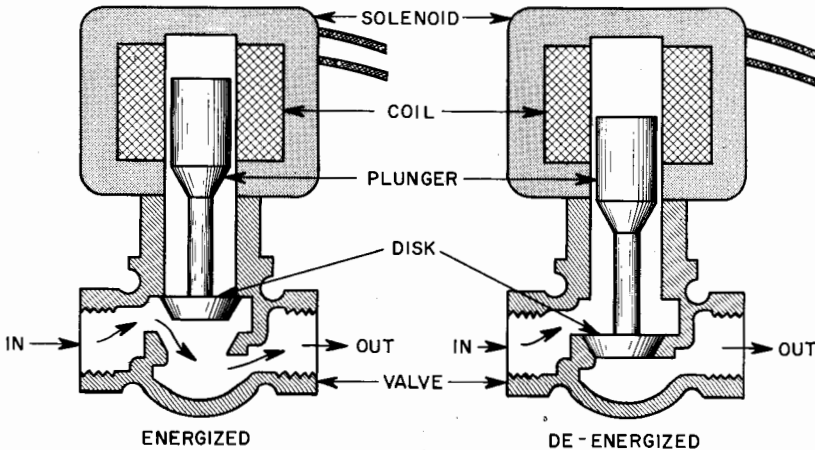

Fig. 78. Controlling solenoid-activated valves.

control elements can be used with these systems. A detector, within the medium, senses flow, rate of flow pressure, temperature, etc., and generates a signal to the controller which is connected in the control loop of the

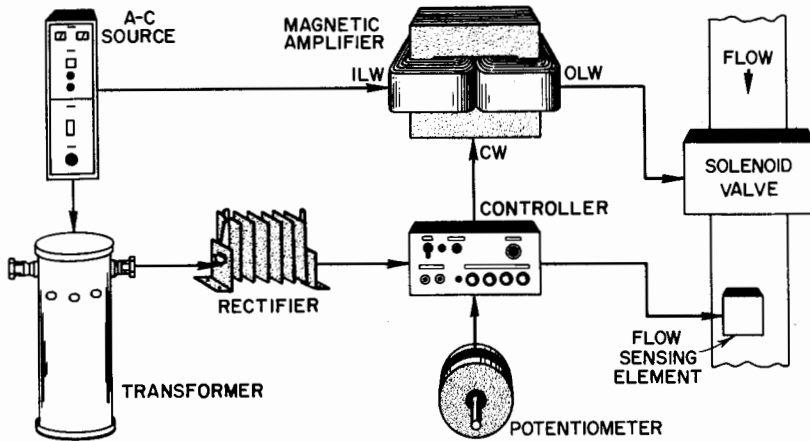

Fig. 79. Control of solenoid actuator valves.

magnetic amplifier. The magnetic amplifier is biased for switching characteristics. Hence, the output of the amplifier energizes or de-energizes the solenoid valve in accordance to the requirements of the system (Fig. 79).

Lighting Control

Television and theater lighting equipment has had a rapid development in recent years. Actors' props and settings must be visible, in proportion to their importance, from all parts of the stage or auditorium. Naturalism, composition, and mood are additional factors to be achieved by artificial stage lighting. These lighting requirements demand a high degree of flexibility in equipment to create brightness, color, distribution of light, and direction and location of equipment. Hence, dimmer control equipment for lighting is an important part of stage equipment.

Magnetic amplifiers are a means of controlling lamp brilliancy by proportional dimming (Fig. 80). Individual or group lighting control is made possible by the use of this component. A manually operated powerstat varies the d-c current control input to the magnetic amplifier. This control current varies the degree of saturation which, in turn, varies the current supplied to the lamps. Power in the order of milliwatts is capable of controlling power in the order of kilowatts.

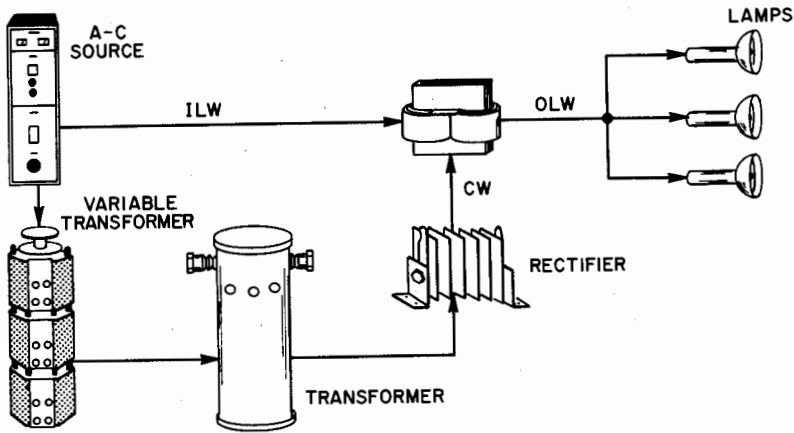

Fig. 80. Light dimming control system.

Overload Detection System

A high degree of reliability is required of the components that make up the circuits which protect electrical systems. Overloads — either overcurrents or overvoltages — pose important operational considerations in these systems. This protection is characterized by an inverse-time relationship, where extreme overloads are allowed to exist for only a brief period of time or slight overloads are allowed to exist for a longer period of time before protective devices are actuated.

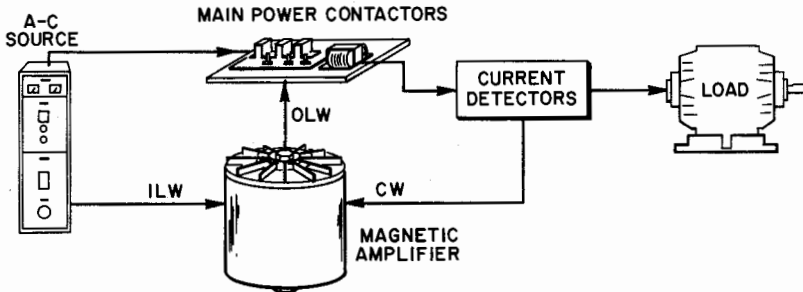

Fig. 81. Overload trip device.

Undervoltage or overvoltage (or current) is sensed as power is delivered to a load. This detector senses voltage changes and generates a signal proportional to these changes to the control winding of a magnetic amplifier. The magnetomotive force developed by the control winding delivers an output which activates or de-activates the main line contactors, opening or closing the circuit (Fig. 81).

Control System for Semiconductor Production

The wide use of transistors and diodes in electrical equipment and circuits, has demanded that the processes used to make these semiconductors, be highly efficient in their productive output. Seed crystal growing is presently the most common and efficient method of obtaining these crystals. This process makes use of a crystal-pulling apparatus shown in Fig. 82.

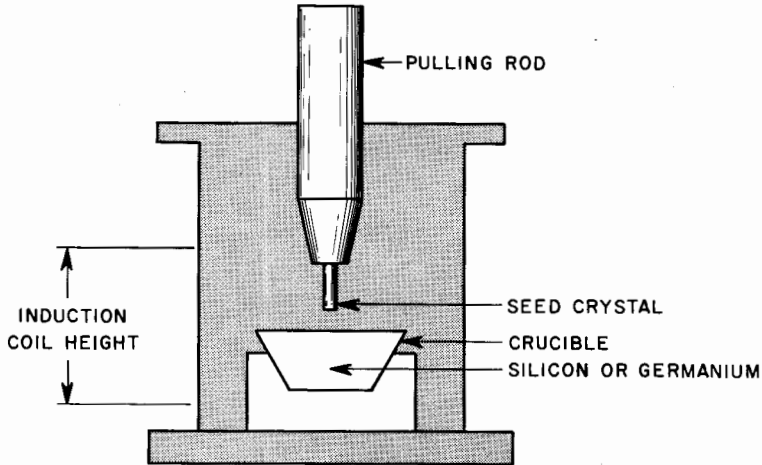

Fig. 82. Crystal-pulling apparatus.

Germanium or silicon, in order to produce a single crystal, is first melted in a crucible — germanium in a carbon crucible silicon inside a carbon crucible with a quartz liner.

A pulling rod, to which the seed is attached, is lowered into the crucible and then slowly withdrawn. This seed is a small piece of crystal with the proper physical crystalline structure. As the metal cools, it forms a single crystalline structure upon the seed. The rate of pull, the size of the seed, and the temperature of the melt, determine the size of the crystal.

The temperatures required for silicon are in the vicinity of 1500°C ; for germanium, approximately 1000°C . Consequently, the heating process to be used must be reliable, adaptable to temperature measurements, and lend itself to accuracy in the controls necessary for the pulling operation.

Fig. 83 illustrates a control system for governing the amount of heat input to the melt, using an induction type of heating process. A temperature sensor generates a signal proportional to the melt temperature, and is an

input signal to the recording potentiometer. The output of the recorder is proportional to the deviation between the set-point and measured variable (a signal proportional to the ordered temperature and actual temperature) and goes to a current proportioning unit. Any deviation from the set-point by the controlled variable results in an error signal applied to a rate network. (The recorder and the proportioning control unit are means of gaining extreme sensitivity.) The output of the proportioning unit is fed into a magnetic amplifier where it is amplified and converted. The output signal then goes to the control winding of a saturable reactor which delivers controlled r-f power or current to the induction coil.

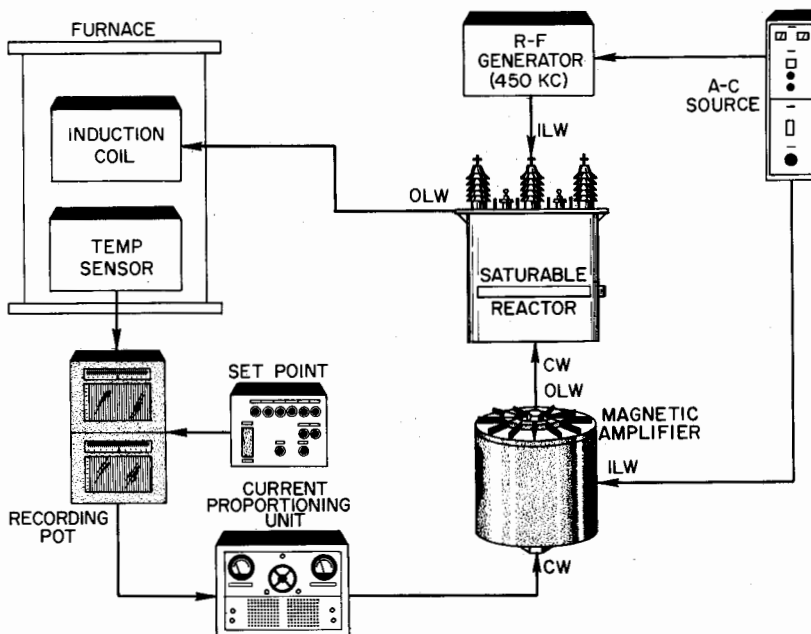

Fig. 83. Control system for semiconductor crystal production.

Temperature-Controlled Ovens

Temperature-controlled ovens must be able to not only maintain a fixed inside temperature in the presence of wide variations in ambient conditions, but also be able to change from one temperature to another with minimum delay. Magnetic amplifiers in the control system (Fig. 84) provide a rugged, reliable and accurate regulated system.

Temperature sensors in the form of a temperature sensing bridge are placed within the oven. This bridge is balanced when the oven reaches an ordered temperature. Temperature fluctuations cause an unbalanced bridge

and cause current to flow in the control winding of the first-stage magnetic amplifier. The output is then fed into the control winding of another magnetic amplifier, which controls the power supplied to the heaters as well as the power supplied to the motors. The motor-driven fans and the heaters, together with a magnetic amplifier, provide a fast-response temperature control system.

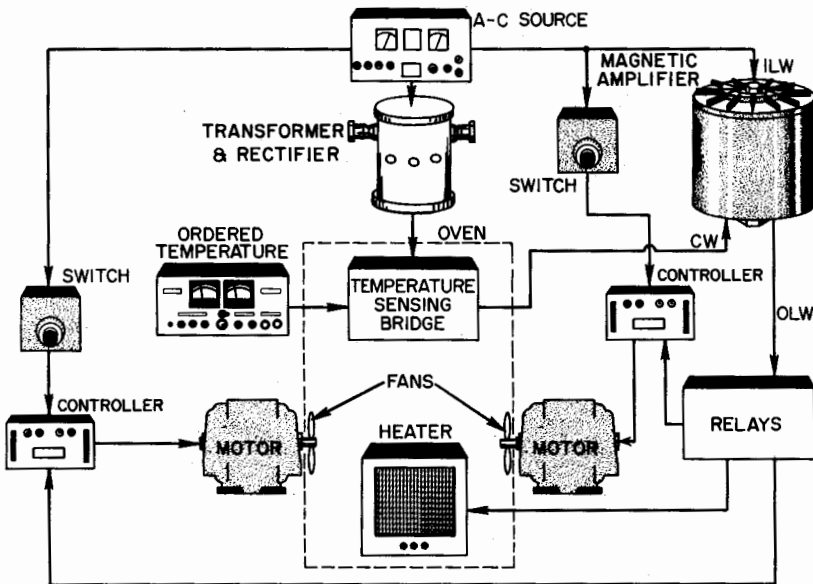

Fig. 84. Temperature control system.

Metering in Electrochemical Systems

The required accuracy in measuring power on the level of 100,000 kw and above (125,000 amps at 800 volts) poses a difficult task for ordinary measuring instruments. Accurate methods of metering mean accurate methods of control. In the aluminum production industry, as well as other chemical processes, large amounts of direct current are required.

A method used requires individual units (rectifiers) paralleled to obtain large currents. The metering of a total current on any line is made by a method of adding the individual currents. Previously, totalizing shunts were used. However, they are difficult to build, install, and are often hazardous to operators and maintenance personnel. Magnetic amplifiers are used not only to meter the pot-line current, but also to expedite the location of trouble in individual cells. This magnetic amplifier type of installation

uses a multiple-wire tap, one on each bar of a bus. The control wire (one per bar) is placed close to the bus but insulated from it, as shown in Fig. 85.

(Note: Pot-lines are a series of furnaces [pots] arranged in a tandum [line] so that materials, such as aluminum, as they are processed, go from one pot to another. Pot-line current would be the current required in the electrochemical process in each pot.)

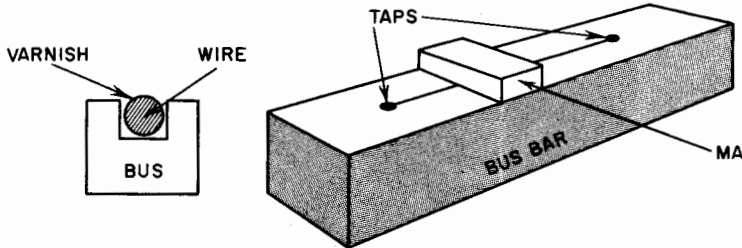

Fig. 85. Bus bar wire tap.

As direct current flows into the bus bar, a proportionate amount is allowed to flow through the bus tap points. The millivolt drop between the tap points varies with the amount of current in the bus. This millivolt drop will (with the millivolt drops of the other bus bars) determine the total

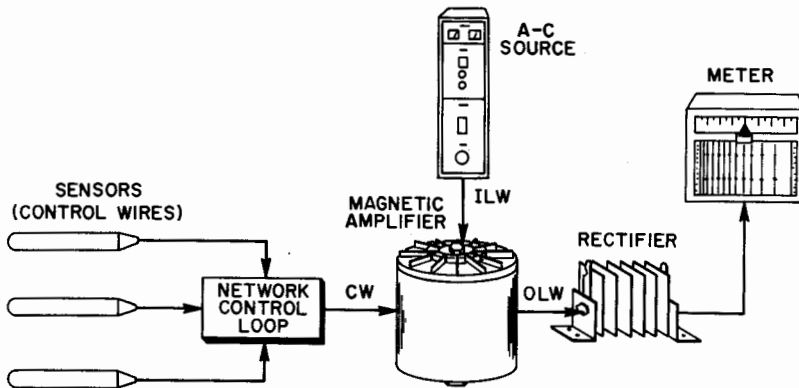

Fig. 86. D-c metering of large power lines.

proportionate amount of current flowing in the system. This is summed in a network control loop (Fig. 86) which generates a proportionate signal. This signal is then fed into the control winding of a magnetic amplifier, and amplified sufficiently to be recorded on a meter.

Speed Control of D-C Motors

The following describes an adjustable speed drive for operation from an a-c power source. Its basic function is to control drive motor speeds in an infinite number of steps over a wide range of speeds.

Operating speed levels as low as $\frac{1}{8}$ of base speed, to as high as five times the base speed, is possible. Base speed is defined as the speed of a d-c motor when rated armature voltage and field strength are applied. A one-line diagram is shown in Fig. 87.

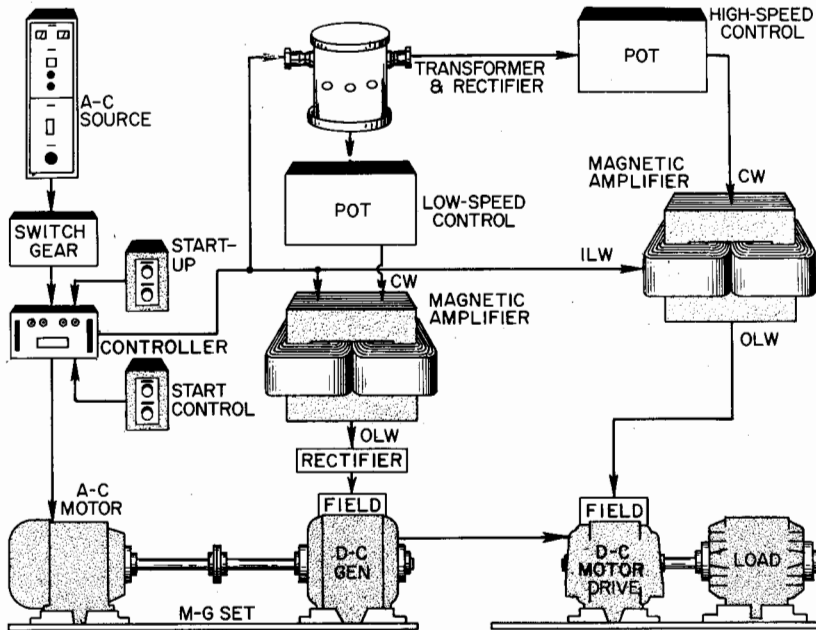

Fig. 87. Speed control of d-c motors from a-c sources.

System Theory

According to d-c motor theory, speed change can be accomplished by either changing armature voltage or changing motor field strength. Applied voltage (V_t) is equal in magnitude to the counter emf (E_c) generated in the motor armature plus the IR drop in the armature. V_t equals E_c plus IR, since E_c equals $K\phi N$. Substituting and rearranging: N equals V_t minus $IR/K\phi$; Where E_c equals counter emf, ϕ equals flux, N equals speed, and K equals constant of the machine construction.

The preceding equation shows that speed is a function of applied voltage, field strength, and armature voltage drop. With a given armature current

and field strength (ϕ), the speed is a function of this terminal voltage (V_t). If terminal voltage is increased, speed increases to produce a greater emf. Also, if the terminal voltage is decreased, speed decreases for the same reason. From the above equation, it is seen that with a constant terminal voltage and rated armature current, speed change can be accomplished by increasing or decreasing the field flux. In accordance with the following expression, motor torque, speed, and horsepower are related. HP equals $NT/5252$; Where N equals speed, T equals torque, and HP equals horsepower. Consequently, varying the armature voltage below base speed results in constant torque; varying the field strength above base speed results in constant horsepower (Fig. 88).

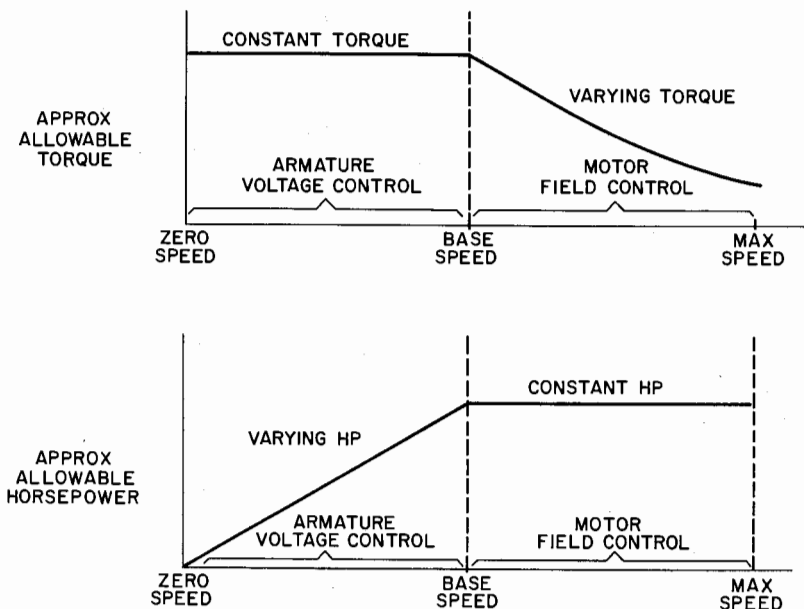

Fig. 88. Motor torque and horsepower curves.

Speed Change Below Base Speed

Speed change below base speed is achieved by varying the voltage across the d-c drive motor armature. This is accomplished by varying the field strength of the d-c generator. Field current is supplied by the power windings of the magnetic amplifier. System operation (Fig. 89) is as follows:

- (1) After start button has been depressed, holding coil M is energized closing all M contacts. This starts the a-c motor driving the d-c generator.
- (2) The start button at control station is depressed, holding coil 1M is

energized, closing all 1M contacts which supply a-c to transformers and rectifiers. This results in direct current being available at control potentiometers A and B. Small currents flow through the power windings of the magnetic amplifiers with low-power transfer to each field. (3) Changing the control current (potentiometer A) in the control winding varies the d-c output from the power windings, which supplies the generator field. This results in a variable output voltage from the generator which is applied to the drive motor armature resulting in a speed change.

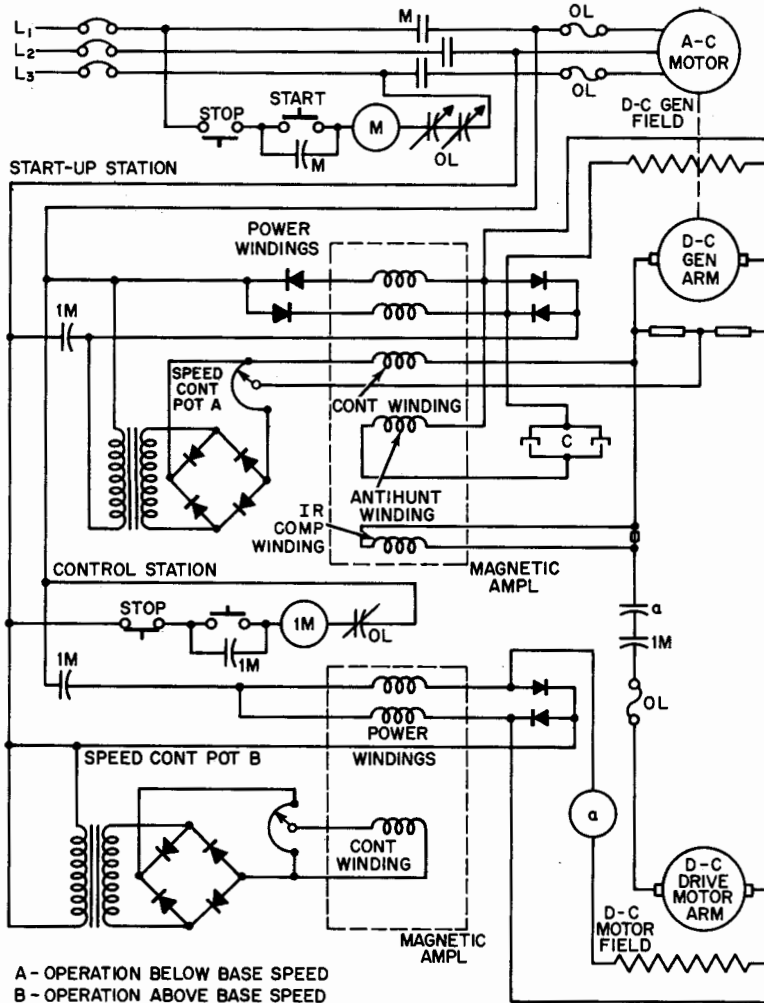

Fig. 89. Diagram of adjustable speed drive.

Speed Change Above Speed Base

To effect a change in speed above base speed, the field strength of the motor is varied. Operation is as follows: (1) Hold generator output voltage constant by leaving potentiometer A alone. (2) Since d-c is available at potentiometer B, varying its output will vary the output of the power windings supplying d-c to the motor field. This strengthening and weakening of the field changes the motor speed.

Use of Special Windings

Power and control windings. These windings function in accordance with basic principles of operation of saturable reactors as brought out earlier.

IR compensating winding. Changes in load result in changes in armature current and reduced motor speed. Since this is objectionable, a means of modifying this effect is accomplished through the use of the IR compensating winding. As armature current increases, a greater flux is developed in the magnetic amplifier, due to the compensating winding which tends to saturate the core. This increases the current in the d-c generator field, increasing the generator voltage. Hence, changes in motor speed due to loads are reduced.

Antihunt winding. The antihunt winding is connected to the generator field through two antihunt capacitors (C). The circuit operates only during changes in speed levels to cushion any abrupt or oscillating changes. This is accomplished by designing the capacitors so that they charge when the field is increasing and discharge when the field is decreasing. This effect of the capacitors is delivered to a winding which introduces opposite saturation effects to that of the power windings.

Regulators (General)

Regulation is the process of keeping constant some condition like speed, temperature, voltage, or position, by an electrical or electronic system which automatically corrects deviations from a desired output (errors). Regulation is, therefore, based on feedback, control is not. Automatic electronic regulators can be designed and constructed to maintain a level of output for the following conditions: Speed, voltage, current, frequency, torque, tension, temperature, position, etc.

The degree to which the regulator keeps constant these conditions, depends upon the accuracy and reliability of the components in the system. The magnetic amplifier serves as an excellent means toward system reliability and accuracy as illustrated and described in the following systems.

Speed Regulators

Speed regulators (Fig. 90) are important where constant speed must be

maintained, such as in the generation of alternating current (d-c motor driving and a-c alternator). Speed variations result not only in poor voltage output, but also in frequency deviations.

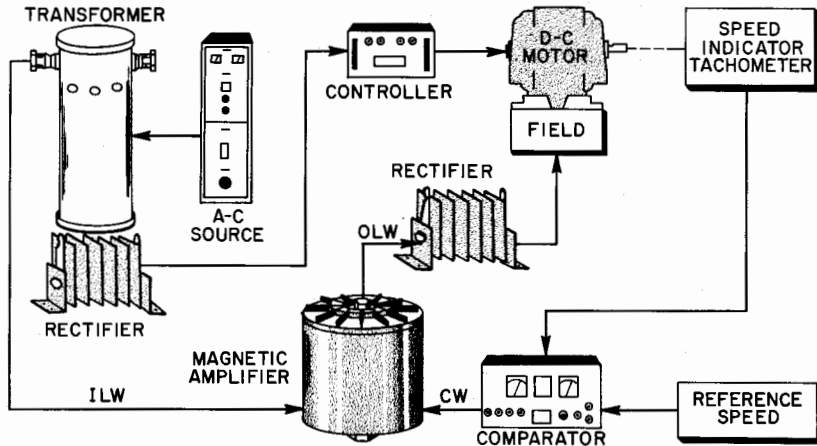

Fig. 90. Speed regulator.

Speed deviations on the motor shaft output is sensed with a tachometer indicator whose proportional signal is compared with a preset reference speed. The output of the comparator is an error signal, proportional to the difference in speed. This error signal goes to the control winding of a magnetic amplifier whose output supplies the excitation current for the motor field.

Automatic Line Voltage Regulators

Fluctuating voltages, both high and low, have undesirable effects on utilization equipment. Low voltage causes lights to dim, motors to slow down or pull out of step, electronic equipment to function improperly, etc. High voltage causes some equipment to perform unsatisfactorily and other equipment, such as lights and control devices, to burn out.

The following describes a voltage regulating system which automatically maintains the output voltage of a generator constant, regardless of load changes. This system makes use of magnetic amplifiers and consists of the following circuits: Start or field flashing circuit, voltage sensing circuit, frequency compensation, reactive droop compensation, voltage adjustment. All these circuits are intended to maintain the system (either for single operation or parallel operation) terminal voltage constant despite load variations.

Starting (Field Flashing) Circuit (Fig. 91)

The diesel-generator system and regulating equipment are started by depressing a master pushbutton. This pushbutton connects a battery power source to the generator field winding while the engine comes up to speed. The battery supplied exciting current is delivered to the field winding of the generator through normally closed contacts of a relay. When the generator output voltage becomes sufficient to energize the relay, the battery circuit is interrupted, permitting the voltage regulator to assume full automatic control of the generator field excitation and output voltage.

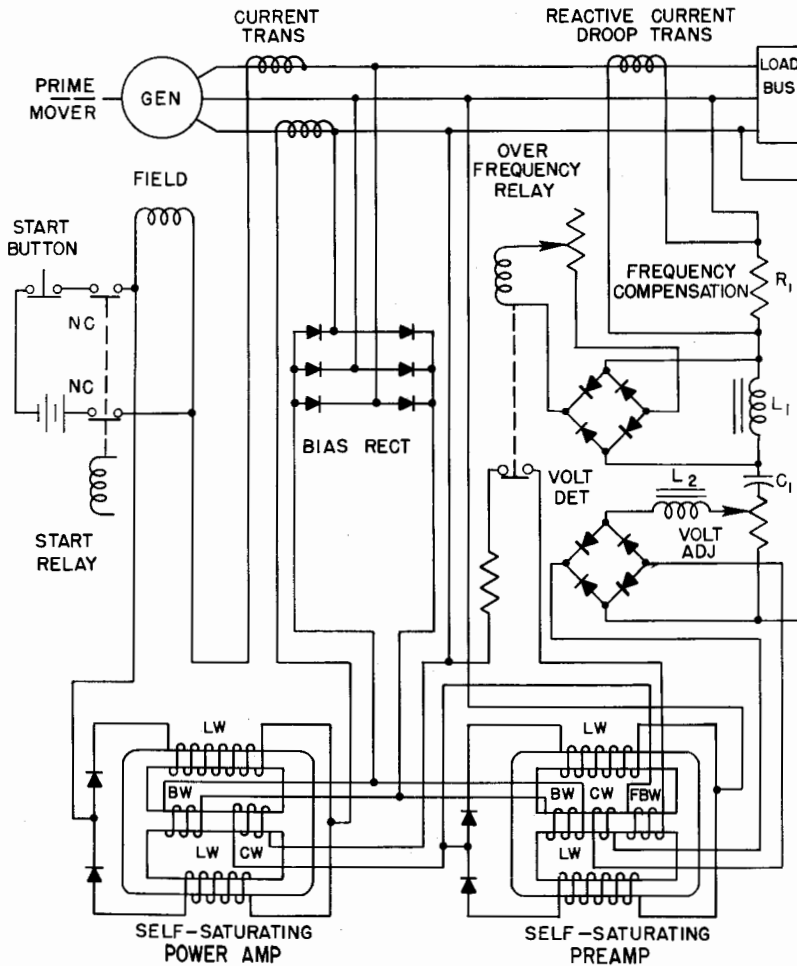

Fig. 91. Automatic line voltage regulator.

Voltage Sensing Circuit

This portion of the circuit receives its signal from the a-c generator output bus. The output voltage of this circuit varies in magnitude and polarity as its input voltage increases and decreases. This is accomplished by the use of reactors and capacitors whose values and connections are such that current through these components are equal at only one voltage value. This is termed the *balance point* of two impedances. The operation of the voltage regulator depends upon the fact that an increase in voltage above the balance point causes an increase in current flow through the series and parallel impedance. When the voltage decreases below the balance point, the current through the series impedance decreases, and the current through the parallel impedance increases. When this unbalance occurs, a current flows in the control winding of the premagnetic amplifier stage. The first stage and second stage magnetic amplifiers are properly biased and supplied with power. The output of the second stage causes the generator field current to change in the proper direction to bring the a-c voltage back to the balance point of the regulator.

Frequency Compensation Circuit

Because variations in the load upon the power supply may cause fluctuations in the speed of the diesel engine, means have been provided to compensate for the effects of variable output frequency. The negative feedback around the preamplifier stage is included to assure stable system operation. A portion of the output signal is connected to oppose the input signal and tends to reduce wide variations in voltage changes. In case of overspeed of the diesel, the over-frequency relay closes, connecting the negative feedback winding. This reduces the voltage to a value which will not damage the regulator. Inductors and capacitors are specified with values so that frequency changes result in reactance changes that can only upset the network balance within a specified band (55–65 cycles).

Reactive Droop Compensation

When generators are required to operate in parallel, the reactive kva carried by each should be in proportion to the generator rating. Division of reactive kva between generators can be obtained by causing each regulator to droop its regulated voltage as the reactive current increases. This is accomplished by a reactive current droop transformer, the output of which is connected to a resistor in the regulator circuit. The voltage droop across the resistor caused by the transformer current gives an indication to the regulator of the amount of reactive current supplied by the generator.

Voltage Adjustment

The voltage adjusting unit is essentially a variable voltage transformer,

connected to provide approximately 20% of the voltage supplied to the regulator. With this unit, it is possible to set the generator voltage at any value within the 20% range. Voltage adjustment is accomplished by changing the balance voltage conditions developed by the L, C, R circuits described previously.

Fig. 92 illustrates another type of voltage regulator for maintaining voltage on transmission lines, and makes use of magnetic amplifier control to change transformer taps in accordance to load fluctuations. This step type regulator is becoming increasingly important.

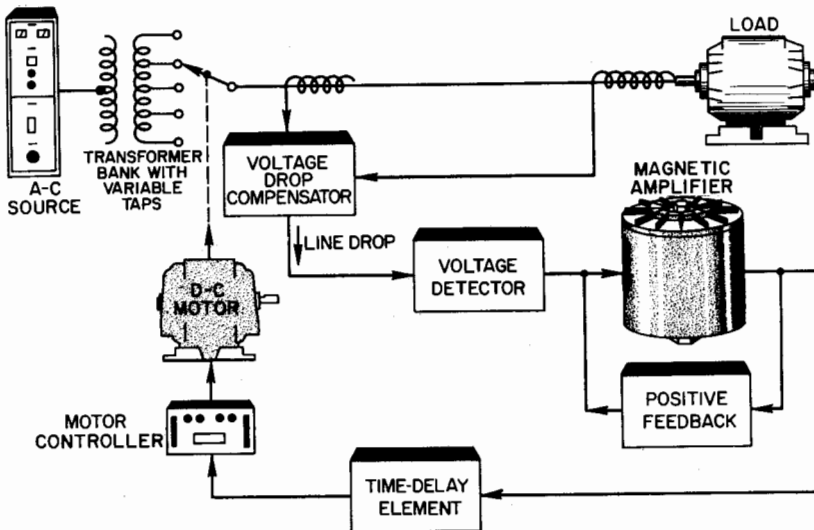

Fig. 92. Magnetic amplifier control for load tap changing equipment.

Step regulators, as the name implies, regulate the voltage in steps. For this reason, the equipment must be designed and connected to perform a level stepping function due to any changes or deviations in voltage. The magnetic amplifier used in this system has a bistable output (Fig. 93).

For certain input signal values, the output may have one of two values. This type of operation gives the magnetic amplifier the necessary bandwidth and compounding requirements for step regulator control.

The voltage drop that may exist between source and load is subtracted from the output voltage of the source (line drop compensator). This voltage is then connected to a detector which generates a proportional signal corresponding to any deviation in voltage from the required balance voltage. If

this voltage exceeds the allowable limit, the voltage-regulating magnetic amplifier will amplify the deviation and send a signal to the time delay unit. While the voltage detector measures the deviation in voltage continuously, no action should take place until this deviation has exceeded the set bandwidth.

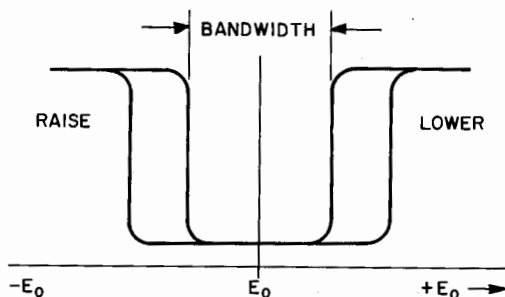

Fig. 93. Bistable output of a magnetic amplifier.

The time delay element provides a means of timing the deviation voltage until the end of the timing period. Then, the bistable magnetic amplifier's output energizes a small control relay which in turn energizes the motor control relays. This starts the motor which changes the necessary taps on the transformer.

Nuclear Reactor Protection Systems

The term *scram* refers to the rapid reduction in nuclear reactor power level. This is accomplished by inserting the control rods into the reactor to bring the reactivity to its lowest state. Fast trip scram circuits are neces-

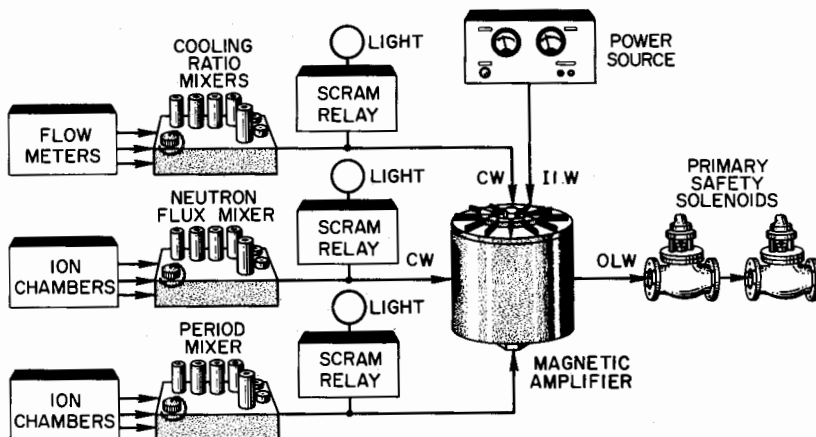

Fig. 94. Nuclear reactor protection system.

sary in reactor systems in the event of any malfunctions. (See Fig. 94.) Three malfunctions are capable of scrambling a nuclear reactor under fast trip conditions: (1) *Neutron flux scram*—The amount of neutron flux present in a reactor is an indication of the actual power level. This is also proportional to the amount of heat generated. If heat becomes excessive, the reactor needs to be scrambled. (2) *Reactor period*—This is the time in seconds in which the reactor power level is increased or decreased by the factor “e” or approximately 2.7. This tells how fast the power levels are changing. (3) *Cooling ratio*—This is a measure of the ratio of neutron flux to coolant flow which is proportional to the difference in temperature between the generating heat source and the coolant removing this heat (ΔT). This also indicates the large upward temperature transients.

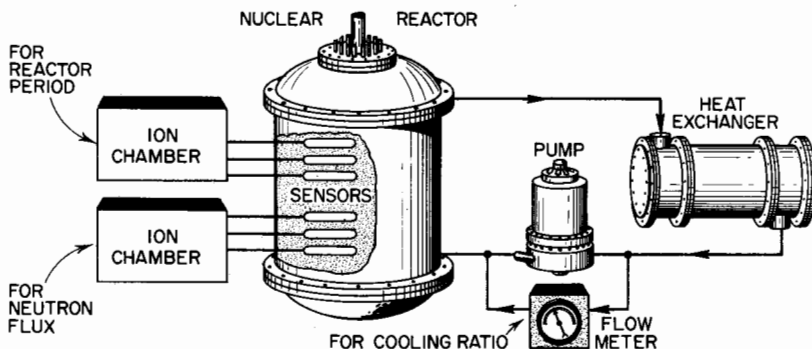

Fig. 95. Malfunctions are detected by sensors.

Cooling ratio, reactor period, and neutron flux malfunctions are detected by sensors (Fig. 95). Detected signals go to mixers whose outputs are connected to one of three control windings of a magnetic amplifier. The duplex bridge-type magnetic amplifier with the three control windings is so biased that the loss of one input causes the output to fall to zero, initiating a fast-trip scram by closing a primary safety solenoid valve.

Control Rod Position Indicator for Nuclear Reactors

Various methods of indicating the position of the control rods in nuclear reactor control systems are used. The following describes a method designed to provide remote indication of the displacement (in inches) of each control rod from the bottom of the reactor. The overall system can be characterized into the following areas: Position indicator coils, inductance bridge, demodulator, premagnetic amplifier and output magnetic amplifier.

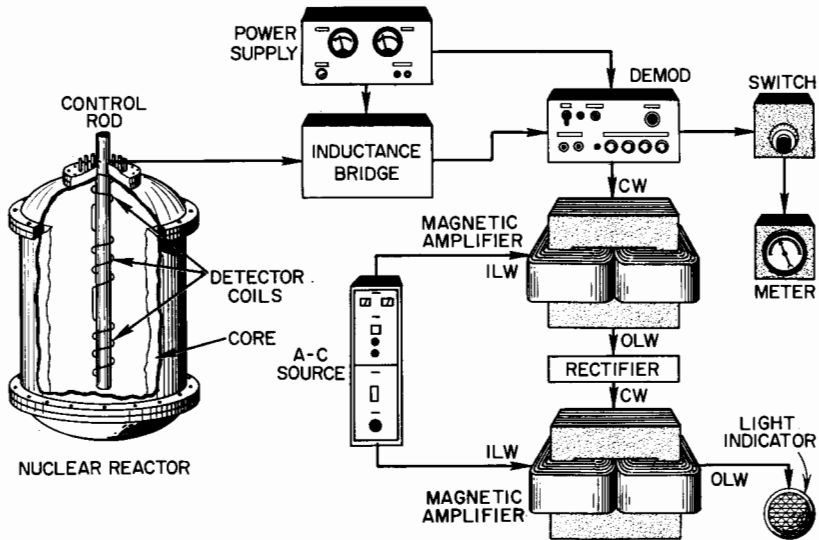

Fig. 96. Indicating system for position of control rod.

Each of these areas are interdependent, and overall system performance depends on the proper operation of each area (Fig. 96).

System Description

The position indicator coil is so installed in the control rod drive mechanism that its inductance is dependent upon the position of the control rod. This is accomplished by installing the detector coil in the hollow center of

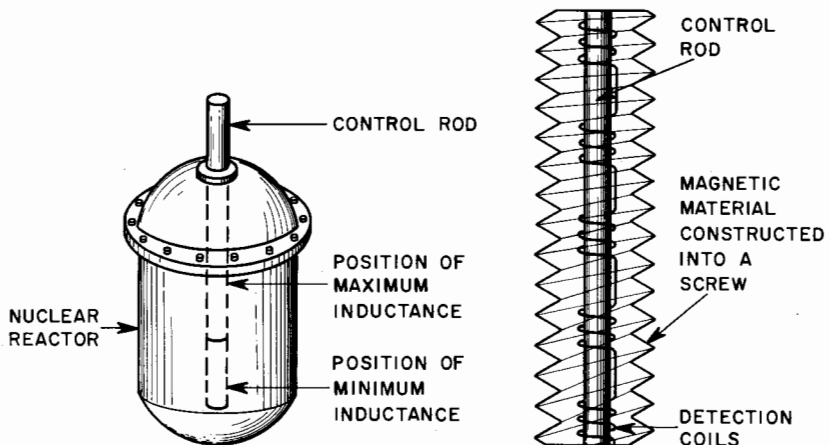

Fig. 97. Effects on inductance due to material and position of control rods.

a screw made of magnetic material and connecting it to the control rod (Fig. 97). Vertical movement of the screw and control rod changes the amount of magnetic material surrounding the detector coil. When the control rod is in the bottom position, the minimum amount of magnetic lead screw material surrounds the detector coil and its inductance is at a minimum. As the screw is raised from the bottom position, more of its magnetic material surrounds the detector coil, causing the inductance to increase. This inductance is the result of the higher permeability of the material surrounding the inductance coil.

Inductance Bridge

When the control rod is in the bottom position, the inductance bridge is balanced (Fig. 98). Any changes in the rod position result in changes in inductance in one arm of the bridge. This unbalanced condition produces an output proportional to the position of the control rod. The basic purpose of the variable resistances in two of the arms of the bridge is to compensate for the decrease in capacitance of the capacitor with an increase in temperature. Once the bridge has become unbalanced, it delivers an a-c output which is applied to the demodulator circuit for rectification. A test inductor is included for circuit testing. This test is accomplished by inserting an inductance of equal value to that obtained when the rod is withdrawn to the halfway position.

The basic purpose of a demodulator is to provide rectification of an a-c signal. The demodulator circuit receives the a-c output of the inductance bridge, rectifies it, and delivers it as a control signal to the preamplifier. The demodulator utilizes two pairs of transistors which operate as synchronous switches. One pair conducts during the positive half cycle, and the second pair conducts during the negative half cycle producing full-wave rectification. An a-c biasing transformer (T1) alternately turns each pair of transistors on and off by applying an a-c voltage between the base and collector. In addition to delivering an output to the preamplifier input, the demodulator also supplies a signal to an indicating meter-selector switch. This is, however, accomplished through a temperature-compensating network. A phase shifting network compensates for changes in inductance from rod position, and changes in resistance of coils due to temperature effects.

The preamplifier is a linear magnetic amplifier whose control signal is fed from the demodulator output to produce an output inversely proportional to the demodulator output, i.e., d-c output decreases as the control current increases. Fixed and adjustable biases provide an output independent of line voltage variations. The output magnetic amplifier is biased to produce an output directly proportional to the output of the preamplifier. With this arrangement, the preamplifier and output amplifier deliver their maxi-

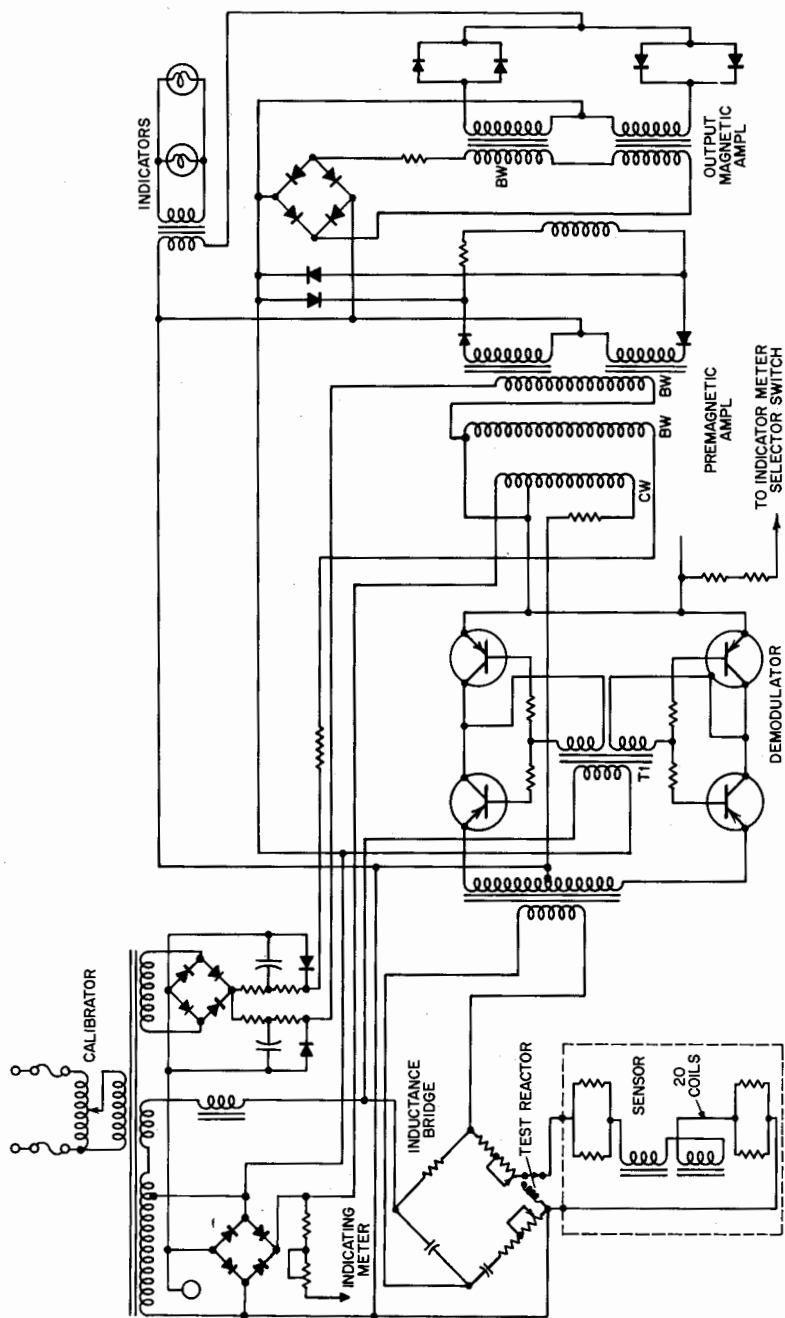

Fig. 98. Nuclear control rod position indicator system.

imum outputs when the inductance bridge is balanced, or the control rod is at the bottom position. This provides fail-safe operation.

Magnetic Core Shift Registers in Digital Computers

Registers used in digital computers are data or information storage devices. Registers can be connected in a circuit to hold (store) a full chain of coded binary data with one bit in each register.

Magnetic cores, acting as magnetic amplifiers, can be connected in cascade to function as a register. When such a chain (Fig. 99) or cascaded cores are used, a shift pulse can shift the entire train of binary information.

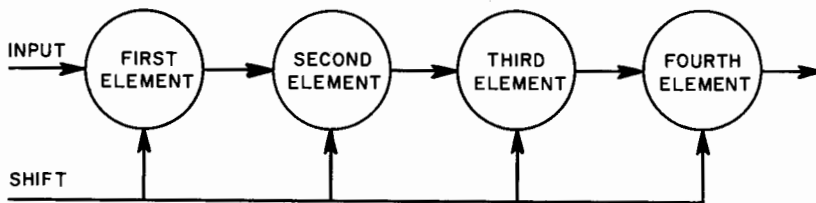

Fig. 99. Cascaded cores function as a storage register.

By this method, each new bit is transferred into the first element. Then the whole train of data is shifted down the line to make room for the next bit. This continues until all information is transferred and stored.

Each element in this chain consists of a magnetic core that can be switched or changed from a negative saturation state to a positive saturation state (Fig. 100), with a high degree of stability in each state. Changing the core from one state to another is accomplished by pulsing the windings in such a manner as to reverse the direction of the flux within the core.

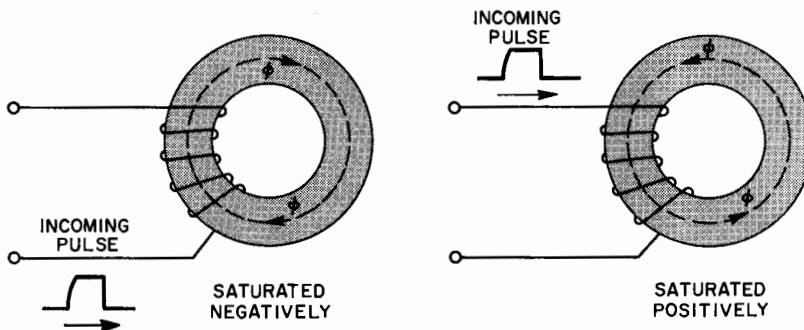

Fig. 100. Magnetic core can be switched from a negative saturation state to a positive saturation state.

The ability of the core to remain in either state indefinitely is attributed to the high degree of retentivity or residual magnetism of the core. Materials having a high residual magnetism exhibit a square hysteresis loop, as in Fig. 101.

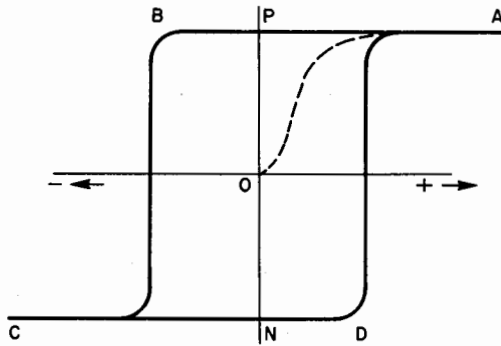

Fig. 101. Square hysteresis loop for magnetic cores.

Properties of Square Hysteresis Loop

- (1) A-B, positive saturation portion of loop.
- (2) C-D, negative saturation portion of loop.
- (3) B and D switching points at knee of curve. These are the points in which positive saturation is changed to negative saturation, and vice versa.
- (4) The change from positive to negative or negative to positive is very sharp.
- (5) Residual magnetism OP (positive) and ON (negative) remains relatively the same through each cycle.
- (6) Magnetic core is never in neutral condition, it switches from one state to another.
- (7) Low impedance at saturation levels which result in maximum current output are necessary to pulse the next magnetic core in cascade.
- (8) Extremely high impedance between saturation levels prevents any output between switching points.

Core-to-Core Transfer

The core-to-core transfer of a magnetic core shift register (Fig. 102) delivers the output pulse from one core to the input of the second core, to switch this second core from one state of saturation to another. In digital computers, the binary digits 0 and 1 are represented in each core element as negative and positive saturation. In other words, a core element in a negative saturation state is said to be in binary state 0, and a core element in a positive saturation state is said to be in a binary state 1.

From Fig. 102, when a pulse arrives in the write winding of core A, it switches the core from negative to positive (0 to 1). The sense winding of

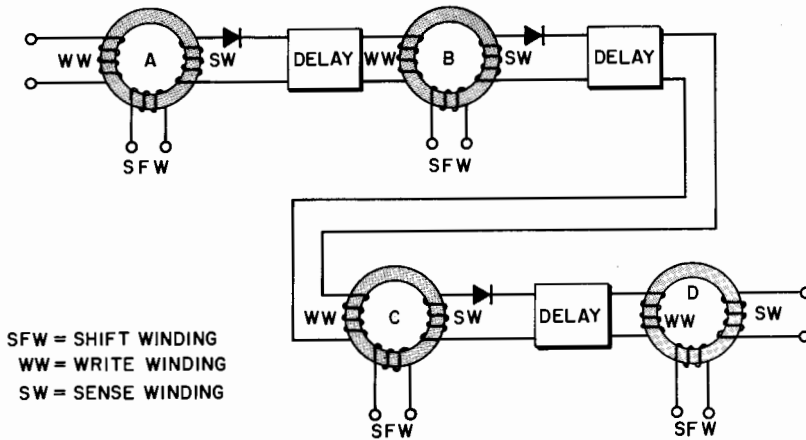

Fig. 102. Core-to-core transfer in a magnetic core shift register.

core A has induced in it an emf, but with a polarity that is reversely applied to the output diode. No conduction occurs between the cores. When an addition pulse arrives in the write winding of Core A, nothing happens because the core is already saturated positively (state 1). When a pulse arrives at the shift winding, the core now changes from a positive to a negative state (1 to 0). The sense winding of core A has induced in it an emf, but with a polarity that is forwardly applied to the output diode, causing conduction between the cores. This conducted pulse is fed into the write winding of core B and changes its state from negative to positive saturation, and the cycle is repeated. The delay element is necessary to prevent the write and shift pulses from coming together in time on any given core. By this method of switching saturation states of a magnetic core, binary information can be stored or held in a register for an indefinite period of time.

To clear or erase a magnetic core shift register, a repeating pulse is applied to the shift windings of each core that has been serially connected. As each shift pulse occurs, every core in the magnetic shift register which is in a 1 state, shifts this 1 to the next core, and so on to the end of the register. This action continues until the register is cleared of all binary 1's.

Review Questions

1. Compile a list of applications, as explained in the text, under the five functional uses of magnetic amplifiers: Control, amplification, switching, memory, computation.
2. What factors give magnetic amplifiers increasing applications in electrical systems?
3. In applying magnetic amplifiers in electrical systems, why is it important that the entire system be considered in the factors of design, operation or maintenance?

- Amplifier, Magnetic* — A device using saturable reactors either alone or in combination with other circuit elements such as rectifiers and resistors, to obtain control or amplification.
- Bias Windings* — Those control windings by which the operating condition is translated by an arbitrary amount.
- Control Characteristic* — A functional plot of load current versus control ampere-turns for various loads and at rated supply voltage and frequency.
- Control Windings* — Those windings by which control magnetomotive forces are applied to the core.
- Efficiency* — Ratio of output to input.
- Flux* — Term used to designate collectively all the magnetic lines of force in a region.
- Gain* — Relative amplitude of output voltage, current, or power, in an amplifier stage or system to the input voltage, current, or power, respectively, expressed in db.
- Hum* — Low audio frequency, equal to, or twice, the power line frequency.
- Impedance* — Total opposition that a circuit offers to the flow of a-c current or any other varying current at a particular frequency. The ratio of the effective value of the potential difference between the terminals to the effective value of current.
- Inductance* — Property of a circuit or two neighboring circuits which determines how much emf will be induced in one of the circuits by a change in current in either of them.
- Linear* — A relation such that any change in one of the related quantities is accompanied by an exact proportional change in the other.
- Noise Level* — The strength of acoustic noise at a particular location.
- Output Windings* — Those windings other than feedback associated with the load and through which power is delivered to the load.
- Reactance* — The opposition in ohms offered to the flow of a-c by inductance or capacitance in an a-c circuit. It is the component of impedance of a circuit not due to resistance.
- Reactor* — A device that introduces reactance (inductive or capacitive) into a circuit.
- Saturable Reactors (also called saturable-core reactors)* — D-c controllable reactors, saturable transformers, and transductors. Saturable reactors

are ferromagnetic inductors in which the current versus voltage relationship, is adjusted by control magnetomotive forces (mmf) applied to the core. This is accomplished by an a-c winding impedance controlled through the saturation of the core effected by a magnetomotive force.

Saturation — Maximum possible magnetization of a magnetic material. Maximum number of lines of flux a magnetic material will hold. Further increases in magnetizing force produces little or no increase in flux density.

Saturation Curve — A magnetization curve for a ferromagnetic material.

Self-Saturation — Refers to the connection of a half-wave rectifying circuit element, in series with the output windings of saturable reactors. Output current has a d-c component to increase the saturation of the core, and results in a reduction in ampere-turn requirements of control winding.

Signal (input and control) — An independent input variable. It is applied to the magnetic amplifier as an independent magnetomotive force.

- Acceleration, 10
- Accuracy, 63
- Air core, 23
- Air gap, 23
- Alignment of domains, 6
- Alignment of electrons, 5
- Ampere-turns, 13, 26, 46
- Amplidyne, 57
- Amplification, 29, 30, 56, 62, 96
- Applications, 72
- Bar, magnet, 12
- Bias, 36
- Bias winding, 46, 96
- Bistable operation, 54
- Calibration, 64
- Cascading, 42
- Coercive force, 18, 66
- Computation, 56, 58, 62
- Conductor, current carrying, 11
- Control, amplifier, 56, 57, 62
- Control characteristic, 32, 96
- Control region, 37
- Control winding, 27, 28, 96
- Core materials, 31
- Core types, 65
- Corrective maintenance, 69
- Cost, 64
- Current gain, 50
- Cut-off region, 37
- Degenerative feedback, 53
- Demagnetized, 5
- Desaturate cycle, 34
- Desaturation, 21
- Dielectric strength, 39
- Digital computers, 93
- Diode, 36
- Distortion, 28, 65
- Domains, 5, 16
- Duty cycle, 63
- Dyne, 10
- Efficiency, 63, 96
- Electrical machinery, 1
- Electrical systems, 41
- Electromagnetic, 4
- Electron emission, 58
- Electron spins, 4
- Electronic amplification, 57
- Faraday's Laws, 19, 20
- Feedback, 53
- Ferromagnetic, 3, 14
- Figure of Merit, 55
- Filter choke, 39
- Flux density, 7, 16
- Flux, properties of, 8, 96
- Force, 10
- Force, attraction and repulsion, 8
- Frequency, 48
- Frequency response, 65
- Full output region, 37
- Fuses, 68
- Gain, 35, 38, 43, 50, 63, 96
- Gauss, 7
- Harmonics, 65
- Heaters, 72
- Helix, 12
- Hermetically sealed, 63
- Hum, 96
- Hysteresis loop, 17, 54, 66, 94
- Impedance, 21, 27, 28, 42, 96
- Impedance range, 64
- Induction, 18, 96
- Inductive reactance, 27
- Inductor, 44
- Instep, 16
- Insulator, 8, 39, 67
- Iron core, 23
- Lighting control, 1, 74
- Linearity, 16, 28, 54, 96
- Lines of flux, 7, 14, 24
- Load resistance, 48
- Load winding, 27, 35
- Long life, 63
- Magnetic amplification, 57, 23, 26

- Magnetic amplifiers:
 - compensating types, 42
 - definition, 34
 - self-saturating type, 34
 - three-legged core type, 39
- Magnetic circuit, 15, 23, 26
- Magnetic conductivity, 14
- Magnetic cores, 93
- Magnetic field intensity, 11, 14
- Magnetic fields, 6, 11
- Magnetism, 3
- Magnetite, 3
- Magnetization curve, 15, 20, 28, 31
- Magnetomotive force, 13, 27
- Maintenance, 68
- Maxwell, 7
- Memory, 56, 58, 62
- Metering in electrochemical systems, 78
- Negative saturation, 18
- Noiseless control, 63
- Noise level, 96
- Nuclear reactor control rods, 89
- Nuclear reactor protection systems, 88
- Output, 42, 53
- Output winding, 96
- Overload detection system, 75
- Overloading, 63
- Paramagnetic, 3, 14
- Permeability, 14, 23
- Phase, 40
- Polarization, 34, 37, 46
- Positive feedback, 54
- Positive saturation, 18
- Power, 28
- Power control to heaters, 72
- Power gain, 50
- Power regulators, 2
- Preventive maintenance, 68
- Punchings, 66
- Quiescent current, 34, 42
- Radiation exposure, 17
- Reactance, 21, 27, 44, 96
- Reactance methods, 58
- Rectangular cores, 66
- Rectifiers, 68
- Rectifying diode, 36, 37
- Regenerative feedback, 53
- Regulators, 83
- Reliability, 63, 72
- Reluctance, 14, 15, 23, 41
- Remote control, 63
- Residual magnetism, 18
- Resistance methods, 58
- Resistivity, 23, 65
- Resistors, 68
- Response, 39, 54
- Ring cores, 66
- Safety, 63
- Saturable reactors:
 - definition, 96
 - history, 1
 - maintenance, 68
 - principle of operation, 28
 - simple type, 26
- Saturation:
 - changes, 21
 - cycle, 34, 96
 - positive or negative, 18
- Self-saturation, 97
- Semi-conductor production, 76
- Sensitivity, 39
- Series-opposing, 40
- Shift registers, 93
- Signal, 97
- Sine-wave, 30
- Slope, 16, 31, 50
- Soft iron, 13
- Solenoid valve control, 73
- Speed control of motors, 80
- Stability, 64
- Stepless control, 63
- Storage, 61
- Supply voltage, 48
- Switching, 56, 58, 62

- Temperature, 67
- Temperature, control ovens, 77
- Tension, 8
- Thermionic emission methods, 58
- Time constants, 54
- Toroid, 7, 13, 15, 39, 66
- Transfer characteristic, 32, 36, 44
- Transformer action, 34, 39
- Transient region, 29
- Transition, 21
- Trim windings, 69
- Troubleshooting, 68, 69, 70
- Unilateral conductivity, 36
- Voltage drop, 28
- Waveform, 29

